

ABB Drives

User's Manual

LONWORKS® Adapter Module

FLON-01



LONWORKS[®] Adapter Module
FLON-01

User's Manual

3AUA0000041017 REV B EN

EFFECTIVE: 28.04.2010

Safety instructions

Overview

This chapter states the general safety instructions that must be followed when installing and operating the adapter module.

The material in this chapter must be studied before attempting any work on, or with, the unit.

In addition to the safety instructions given below, read the complete safety instructions of the specific drive you are working on.

General safety instructions



WARNING! All electrical installation and maintenance work on the drive should be carried out by qualified electricians.

The drive and adjoining equipment must be properly earthed.

Do not attempt any work on a powered drive. After switching off the mains, always allow the intermediate circuit capacitors 5 minutes to discharge before working on the frequency converter, the motor or the motor cable. It is good practice to check (with a voltage indicating instrument) that the drive is in fact discharged before beginning work.

The motor cable terminals of the drive are at a dangerously high voltage when mains power is applied, regardless of motor operation.

There can be dangerous voltages inside the drive from external control circuits even when the drive mains power is shut off. Exercise appropriate care when working on the unit. Neglecting these instructions can cause physical injury or death.

Table of contents

Safety instructions	5
Overview	5
General safety instructions	5
 Table of contents	 7
 Introduction	 13
Intended audience	13
Before you start	13
What this manual contains	13
Further information	14
 Overview	 15
Overview	15
LonWorks® system	15
Adapter module	16
Compatibility	17
Delivery check	17
 Mechanical installation	 19
Mounting	19
 Electrical installation	 21
Overview	21
General cabling instructions	21
Network connection	22
Bus termination	22
Earthing of the LonWorks® cable screens	23

Drive configuration	25
Overview	25
Drive configuration	25
Control locations	30
Communication	31
Overview	31
General	31
LonMark® objects	32
Node object	32
Variable speed motor drive object	33
Open loop actuator object: DigitalCommand	35
Open loop sensor object: DigitalStatus	35
Open loop sensor object: DigitalInput	36
Open loop sensor object: DigitalOutput	36
Open loop actuator object: AnalogCmd	36
Open loop sensor object: AnalogStatus	37
Resource files	38
Network variables	39
Supported input network variables	39
nviAnlgCmd1 ... nviAnlgCmd8	41
nviCtlOverrideCm	42
nviDigCmd1 ... nviDigCmd12	43
nviDrvProcStpt	44
nviDrvSpeedScale	45
nviDrvSpeedStpt	46
nviEmrgOverride	47
nviExt1Ext2Ctrl	48
nviLocLock	48
nviRequest	49
nviResetFault	50
nviRunEnable	51
nviSavePars	51
nviStartEnable1	52

nviStartEnable2	52
Supported output network variables	53
nvoAccelerating	56
nvoAlarm	57
nvoAnlgInput1 ... nvoAnlgInput8	58
nvoAnlgOutput1 ... nvoAnlgOutput8	59
nvoAnlgSts1 ... nvoAnlgSts8	60
nvoAtReference	61
nvoBypKwh_R	62
nvoBypRunHours	63
nvoBypTemp	64
nvoCtlOverrideSt	65
nvoDecelerating	66
nvoDigInput1 ... nvoDigInput12	67
nvoDigOutput1 ... nvoDigOutput12	68
nvoDigSts1 ... nvoDigSts12	69
nvoDrvCurnt	70
nvoDrvDCBus	71
nvoDrvKwh_NR	72
nvoDrvKwh_R	73
nvoDrvPwr	74
nvoDrvRunHours	75
nvoDrvSpeed	76
nvoDrvTemp	77
nvoDrvTorque	78
nvoDrvVolt	79
nvoEmrgOvrStat	80
nvoEnabled	81
nvoExt1Ext2Stat	82
nvoFaultCode	83
nvoFaulted	84
nvoForward	85
nvoFreqAct	86
nvoLimit	87
nvoLineUVolt, nvoLineVWVlt, nvoLineWUVolt	88
nvoLineVolt	89
nvoLocRemStat	90
nvoMtrRevCntM	91

nvoMtrTemp	92
nvoNetCtrl	93
nvoNetRef1	94
nvoNetRef2	95
nvoParReadValue	96
nvoPid1Dev, nvoPid2Dev	97
nvoPid1Fbk, nvoPid2Fbk	98
nvoReady	99
nvoReverse	100
nvoRunning	101
nvoSpeedActRpm	102
nvoStarted	103
nvoStatus	104
nvoZeroSpeed	105
Supported network configuration properties	106
SCPTdefScale / nciDrvSpeedScale	109
SCPTlocation / nciLocation	109
SCPTmaxRcvTime / nciAnlgRcvHrtBt	110
SCPTmaxRcvTime / nciDigRcvHrtBt	111
SCPTmaxRcvTime / nciVsmdRcvHrtBt	112
SCPTmaxSendTime / nciAnlgSndHrtBt	113
SCPTmaxSendTime / nciDigSndHrtBt	114
SCPTmaxSendTime / nciVsmdSndHrtBt	115
SCPTmaxSetpoint / nciMaxSpeed	116
SCPTminSendTime / nciAnlgMinOutTm	117
SCPTminSendTime / nciDigMinOutTm	118
SCPTminSendTime / nciVsmdMinOutTm	119
SCPTminSetpoint / nciMinSpeed	120
SCPTnomFreq / nciNmlFreq	121
SCPTnomRPM / nciNmlSpeed	122
SCPTrampDownTm / nciRampDownTm	123
SCPTrampUpTm / nciRampUpTm	123
UCPTbypRunDelay / nciBypRunDelay	124
UCPTdrvCurntLimit / nciDrvCurntLimit	124
UCPTparReadIndex / nciParReadIndex	125
UCPTparValue / nciParWriteValue	125
UCPTparWriteIndex / nciParWriteIndex	126
UCPTpid1DerFiltTime / nciPid1DerFiltTi,	

UCPTpid2DerFiltTime / nciPid2DerFiltTi	127
UCPTpid1DerTime / nciPid1DerTime, UCPTpid2DerTime / nciPid2DerTime	128
UCPTpid1Gain / nciPid1Gain, UCPTpid2Gain / nciPid2Gain	129
UCPTpid1IntTime / nciPid1IntTime, UCPTpid2IntTime / nciPid2IntTime	130
UCPTstopLevel / nciStopLevel	131
UCPTstopMode / nciStopMode	132
 Diagnositics	 133
LED indications	133
 Technical data	 135
FLON-01	135
LonWorks® network	136
 Definitions and abbreviations	 141
 APPENDIX: Compatibility table	 145
Supported network variables in alphabetical order	145

Introduction

Intended audience

The manual is intended for the people who are responsible for commissioning and using an adapter module. The reader is expected to have a basic knowledge of electrical fundamentals, electrical wiring practices and how to operate the drive.

Before you start

It is assumed that the drive is installed and ready to operate before starting the installation of the extension module.

In addition to conventional installation tools, have the drive manuals available during the installation as they contain important information not included in this manual. The manuals are referred to at various points of this document.

What this manual contains

Note: The contents of this manual are compatible with FLON-01 firmware 1.02d or later.

This manual contains information on the wiring, configuration and use of the adapter module.

Safety instructions are featured in the first few pages of this manual.

Overview contains a short description of the LONWORKS[®] system and the adapter module, and a delivery checklist.

Mechanical installation contains placing and mounting instructions for the module.

Electrical installation contains the wiring instructions.

Drive configuration explains how to program the drive before the communication through the adapter module can be started.

Communication contains a description of how data is transmitted through the adapter module.

Network variables presents the network variable list of the adapter module.

Diagnostics explains how to trace faults with the status LEDs on the adapter module.

Technical data contains information on physical dimensions, configurable settings and connectors of the module and the specification of the fieldbus link.

Definitions and abbreviations

APPENDIX: Compatibility table lists the network variables that are used with the drives compatible with the adapter module.

Further information

Further information is available on the Internet from www.lonmark.org and www.echelon.com.

Overview

Overview

This chapter contains a short description of the LONWORKS[®] system and the adapter module, and a delivery checklist.

LONWORKS[®] system

The LONWORKS[®] system is an open serial communication solution that enables data exchange between all kinds of automation components.

A LONWORKS[®] network consists of intelligent devices, called nodes, connected by one or more communications media that communicate with one another using the LonTalk[®] protocol. A LONWORKS[®] network can consist of up to 32385 nodes divided into 255 subnets (127 nodes/subnet). Nodes are programmed to send messages to one another in response to external events or messages they receive. Each intelligent device, for example a programmable thermostat in a building control system, is a LONWORKS[®] node. A node is connected to other nodes with appropriate communications media, such as twisted pair cable, RF link, or power line circuit.

Each node includes a physical interface, *transceiver*, that interfaces with the communication media. The adapter module uses the FT-X1 Free Topology Transceiver (compatible with the FTT-10A transceiver) from Echelon Corporation. This commonly used twisted-pair media supports star, bus, and loop wiring. The FT-X1 transceiver connects to a twisted pair cable with a baud rate of 78 kbit/s and appears as high impedance to the network when unpowered, hence it does not interfere with the network communications when powered down.

LONWORKS[®] nodes are objects that respond to various inputs and that produce desired outputs. Connecting the inputs and outputs

of these network objects enables the network to perform specific tasks.

While the function of any particular node may be quite simple, the interaction among nodes enables a LONWORKS® network to perform complex tasks. A benefit of LONWORKS® networks is that a small number of common node types may perform a broad spectrum of different functions depending on how they are configured and connected.

Adapter module

The adapter module is an optional device which enables the connection of an ABB drive to a LONWORKS® network. See the figure below on the adapter module and the construction of the network. Through the adapter module, it is possible to:

- give control commands to the drive (Start, Stop, Run enable, etc)
- feed a motor speed or frequency reference to the drive
- give a process actual value or a process reference to the PID controller of the drive
- read status information and actual values from the drive
- change drive parameter values
- reset a drive fault
- control other LONWORKS® nodes.

The network variables and functions supported by the adapter module are discussed in chapters [Drive configuration](#), [Communication](#) and [Network variables](#).

The adapter module is mounted into an option slot on the motor control board of the drive. See the drive documentation for module placement options.

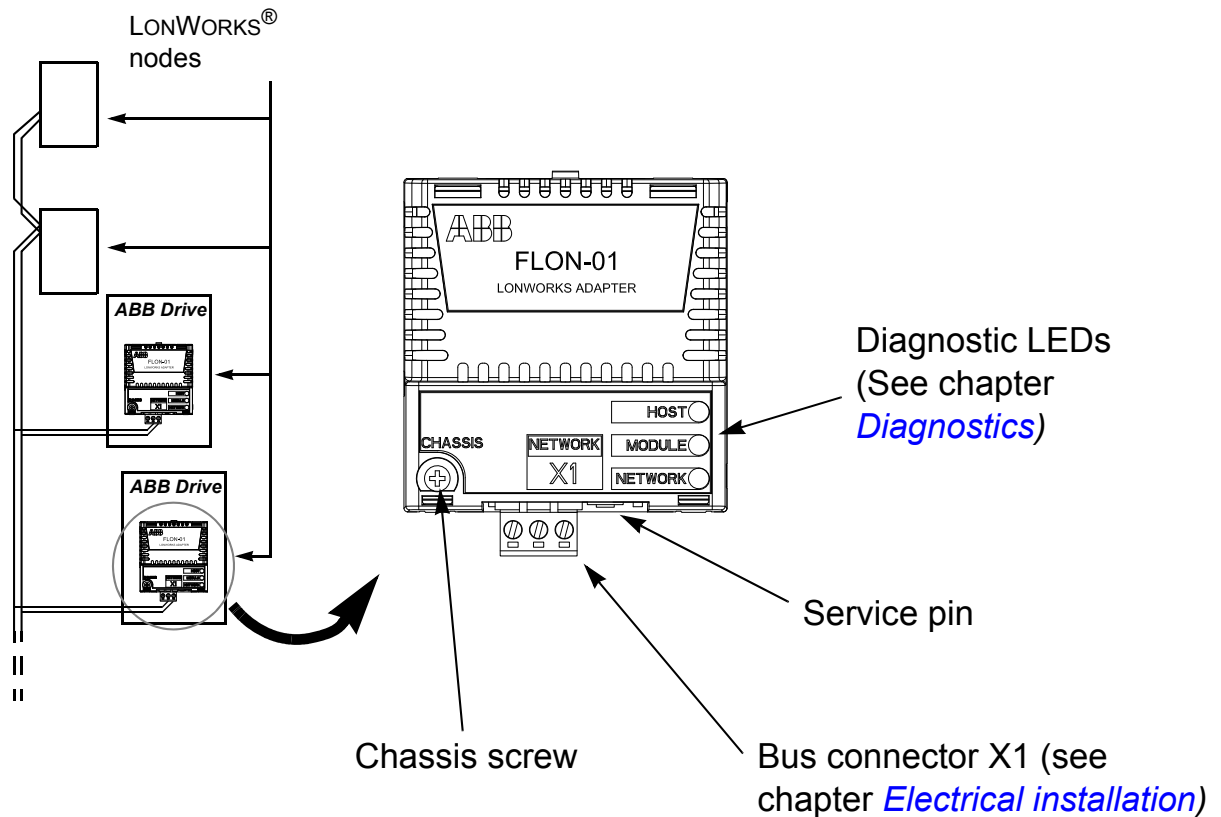

Compatibility

The adapter module interoperates with all LONWORKS® devices.

Note: LONWORKS® supports a variety of media. The adapter module supports TP/FT-10 media. A LONWORKS® router would be required for the adapter module to interoperate with devices on other media.

For drive-specific network variables, see chapter [APPENDIX: Compatibility table](#).

Delivery check

The option package for the adapter module contains:

- LONWORKS® Adapter module, type FLON-01
- this manual.

Mechanical installation



WARNING! Follow the safety instructions given in this manual and the drive documentation.

Mounting

The adapter module is to be inserted into its specific position on the drive. The adapter module is held in place with plastic pins and one screw. The screw also provides the earthing of the fieldbus cable shield connected to the adapter module.

On installation of the adapter module, the signal and power connection to the drive is made through a 20-pin connector. (The connector on the controlled equipment may have fewer pins as not all available signals are necessarily used.)

Mounting procedure:

- Insert the module carefully into its position on the drive.
- Fasten the screw.

Note: The correct installation of the screw is essential for fulfilling the EMC requirements and for proper operation of the adapter module.

Electrical installation

Overview

This chapter contains:

- general cabling instructions
- instructions for bus termination
- instructions for connecting the module to the LONWORKS[®] network.



WARNING! Before installation, switch off the drive power supply. Wait five minutes to ensure that the capacitor bank of the drive is discharged. Switch off all dangerous voltages connected from external control circuits to the inputs and outputs of the drive.

General cabling instructions

Arrange the bus cables as far away from the motor cables as possible. Avoid parallel runs. Use bushings at cable entries.

Network connection

The bus cable is connected to terminal block X1 on the adapter module.

X1		Description
1	SHLD	RC-filtered connection to the module ground
2	NET A	Network Connection A*
3	NET B	Network Connection B*

*For the LONWORKS® TP/FT-10 topology, either network connection may be connected to either pin.

Bus termination

The bus line is terminated with resistors connected between the network cable conductors A and B when the adapter module is at the end of the bus. Termination prevents signal reflections from the bus cable ends. See the figure below on the bus termination for different network topologies.

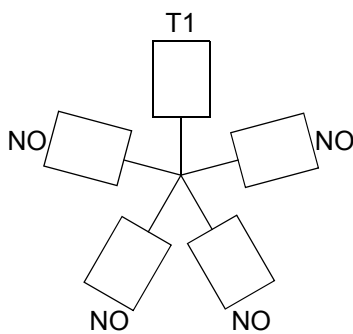

a) Star topology

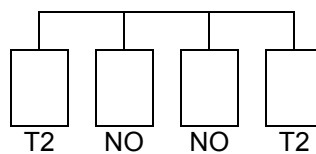

b) Bus topology

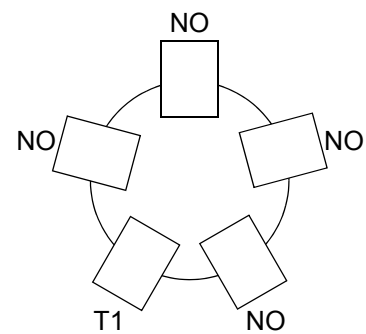

c) Ring topology

T1	52.5-ohm termination at one of the nodes in one bus segment
T2	105-ohm termination at both ends of the line
NO	No termination

Drive configuration

Overview

This chapter gives information on configuring the drive for communication through the adapter module.

Note: The adapter module cannot control the drive before it is configured for the LONWORKS[®] network. The LONWORKS[®] communication configuration does not require parametrisation of the drive. The LONWORKS[®] network is configured using a network installation tool. Refer to the installation tool documentation for network configuration and to chapter [Communication](#) for the resource files.

Drive configuration

It is preferable to configure the drive before the adapter module is configured for the network. The reason for this is that the adapter module reads several parameter values from the drive to operate correctly and to select different modes. Furthermore, some of the configuration network variable values receive their defaults from the drive. The drive control location parameters should also be set accordingly to enable full and logical operation of the adapter module. See [Control locations](#). For more information on configuring the drive, refer to the drive documentation.

Information parameters of the adapter module		
Fieldbus par. no.	Parameter name	Description
1	MODULE TYPE	Type of the module (LonWorks)
2	NODE STATE	State of the adapter module
3-8	NEURON ID [5 ... 0]	Neuron [®] chip ID
9	NODE ADDRESS 1	ID of the node within this subnet
10	NODE SUBNET 1	Subnet (1) to which the node belongs
11-16	DOMAIN ID 1 [4 ... 0]	Domain ID in a LonWorks network
17	NODE ADDRESS 2	ID of the node within this subnet
18	NODE SUBNET 2	Subnet (2) to which the node belongs
19-24	DOMAIN ID 2 [4 ... 0]	ID in a LonWorks network
25	XMIT ERRORS	Number of CRC errors
26	TRANS TIMEOUTS	Number of transmission failures

Note: These parameters become visible in the drive only after the adapter module has been configured on the network side.

MODULE TYPE

Explanation:

This parameter shows the module type as detected by the drive. The value cannot be adjusted by the user. (If this parameter is undefined, the communication between the drive and the module has not been established.)

NODE STATE

Explanation:

This parameter contains the current state of the network interface. Configured on-line is the normal run-time mode and means that the node is commissioned and on-line on the network. Soft/Bypass*/Hard off-line means that the node is not participating actively on the network.

The byte has the following bit assignments:

B	x	x	x	M	S	S	S
---	---	---	---	---	---	---	---

B = bypass*

x = not used

M = mode

S = state.

Bxxx	MSSS	State
xxxx	x011	Unconfigured – without application
xxxx	x010	Unconfigured – with application
xxxx	x110	Configured – hard offline
0xxx	1100	Configured – soft offline
1xxx	1100	Configured – bypass offline*
0xxx	0100	Configured – offline

* not for generic drive use

NEURON ID

Explanation:

This parameter displays the Neuron® chip ID of the module in decimal format. The ID is determined by the chip and cannot be changed.

Par. 3: NEURON ID [5] = byte 6 of the unique Neuron ID (MSB)

Par. 4: NEURON ID [4] = byte 5 of the unique Neuron ID

Par. 5: NEURON ID [3] = byte 4 of the unique Neuron ID

Par. 6: NEURON ID [2] = byte 3 of the unique Neuron ID

Par. 7: NEURON ID [1] = byte 2 of the unique Neuron ID

Par. 8: NEURON ID [0] = byte 1 of the unique Neuron ID (LSB)

The decimal values of the parameters are converted to Neuron ID as shown by the following example:

Parameter 3 = 4 = 04h

Parameter 4 = 118 = 76h

Parameter 5 = 213 = D5h

Parameter 6 = 244 = F4h

Parameter 7 = 1 = 01h

Parameter 8 = 0 = 00h

These decimal parameter values yield a Neuron ID of 0476D5F40100h.

NODE ADDRESS 1

This parameter indicates the ID of the node within the subnet.

Range:

1 - 127 (0 = node address 1 not assigned).

NODE SUBNET 1

Explanation:

This parameter indicates to which subnet the node belongs.

Range:

1 - 255 (0 = node subnet 1 not assigned).

DOMAIN ID 1

Explanation:

This parameter indicates the ID of the domain within this subnet. Each domain in a LonWorks® network has a unique ID of 0, 1, 3 or 6 bytes in length. If the ID is shorter than 6 bytes, it is left justified in this field.

DOMAIN ID 1 [5] = byte 6 of the domain ID (MSB)

DOMAIN ID 1 [4] = byte 5 of the domain ID

DOMAIN ID 1 [3] = byte 4 of the domain ID

DOMAIN ID 1 [2] = byte 3 of the domain ID

DOMAIN ID 1 [1] = byte 2 of the domain ID

DOMAIN ID 1 [0] = byte 1 of the domain ID (LSB)

NODE ADDRESS 2

Explanation:

This parameter indicates the ID of the node within this subnet.

Range:

1 - 127 (0 = node address 2 not assigned).

NODE SUBNET 2

Explanation:

This parameter indicates to which subnet the node belongs.

Range:

1 - 255 (0 = node subnet 2 not assigned).

DOMAIN ID 2

Explanation:

This parameter indicates the ID of the domain within this subnet. Each domain in a LonWorks® network has a unique ID of 0,1,3 or 6 bytes in length. If the ID is shorter than 6 bytes, it is left justified in this field.

DOMAIN ID 2 [5] = byte 6 of the domain ID (MSB)

DOMAIN ID 2 [4] = byte 5 of the domain ID

DOMAIN ID 2 [3] = byte 4 of the domain ID

DOMAIN ID 2 [2] = byte 3 of the domain ID

DOMAIN ID 2 [1] = byte 2 of the domain ID

DOMAIN ID 2 [0] = byte 1 of the domain ID (LSB)

XMIT ERRORS

Explanation:

This parameter indicates the number of CRC errors detected during packet reception. An increasing value may be due to collisions or noise on the transceiver input.

TRANS TIMEOUTS

Explanation:

This parameter indicates the number of times that the node failed to receive expected acknowledgements or responses after retrying configuring number of times. An increasing value may be

due to destination nodes being inaccessible on the network, transmission failures because of noise on the channel, or if any destination node has insufficient buffers or receive transaction records.

Control locations

ABB drives can receive control information from multiple sources including digital inputs, analogue inputs, the drive control panel and a communication module (eg, adapter module). ABB drives allow the user to separately determine the source for each type of control information (Start, Stop, Direction, Reference, Fault Reset, etc). To give the fieldbus master station the most complete control over the drive, the communication module must be selected as source for this information. See the user documentation of the drive for information on the selection parameters.

Communication

Overview

This chapter describes the operation of the adapter module on a LONWORKS® network.

General

In LONWORKS® networks, the network design emphasis is on designing the network variable connections. The connection design determines the amount of data flow between different nodes, thus determining the decision of transmission media and network topology overall in the network.

In designing the connections, the selection of protocol services is also crucial when determining the network data flow. By default, the network connections use acknowledged messaging with a certain retry count. This can, however, be changed by the installation tool to optimize the overall network performance.

To be able to realize the required operation of the whole system, a clear picture of the capabilities of individual nodes is needed. These capabilities are determined by the network variables.

LONMARK® objects

The adapter module includes a node object, a drive object and several open loop sensor or actuator objects. The node object is used to control the drive object. The drive object realizes the LONMARK® Functional Profile: 'Variable Speed Motor Drive Version', 1.1. The profile defines a set of network variables and configuration properties. In addition, the drive object includes a set of manufacturer defined network variables and configuration properties that are defined to realize functions only applicable for ABB drives.

The network variables and configuration properties included by the node, drive and open loop sensor/actuator objects are detailed in chapter [Network variables](#).

Node object

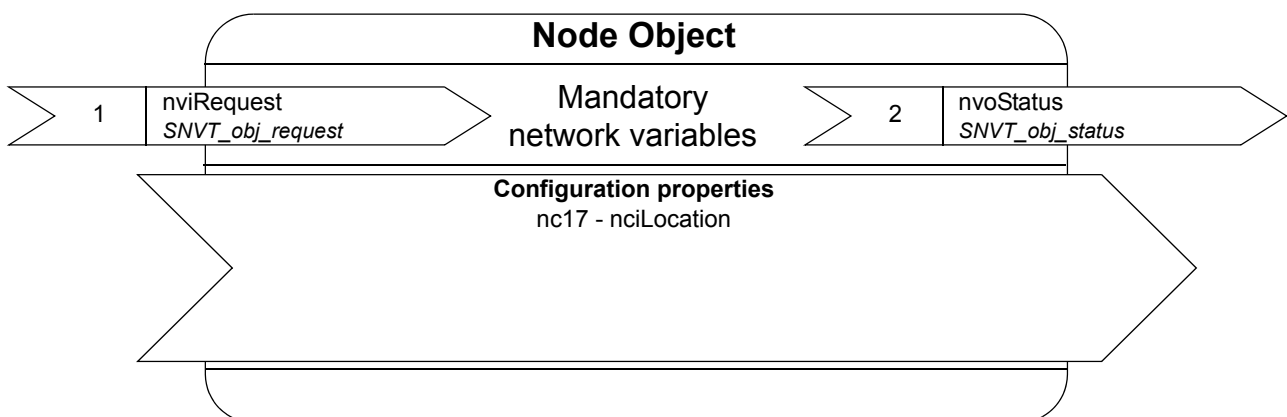

Variable speed motor drive object

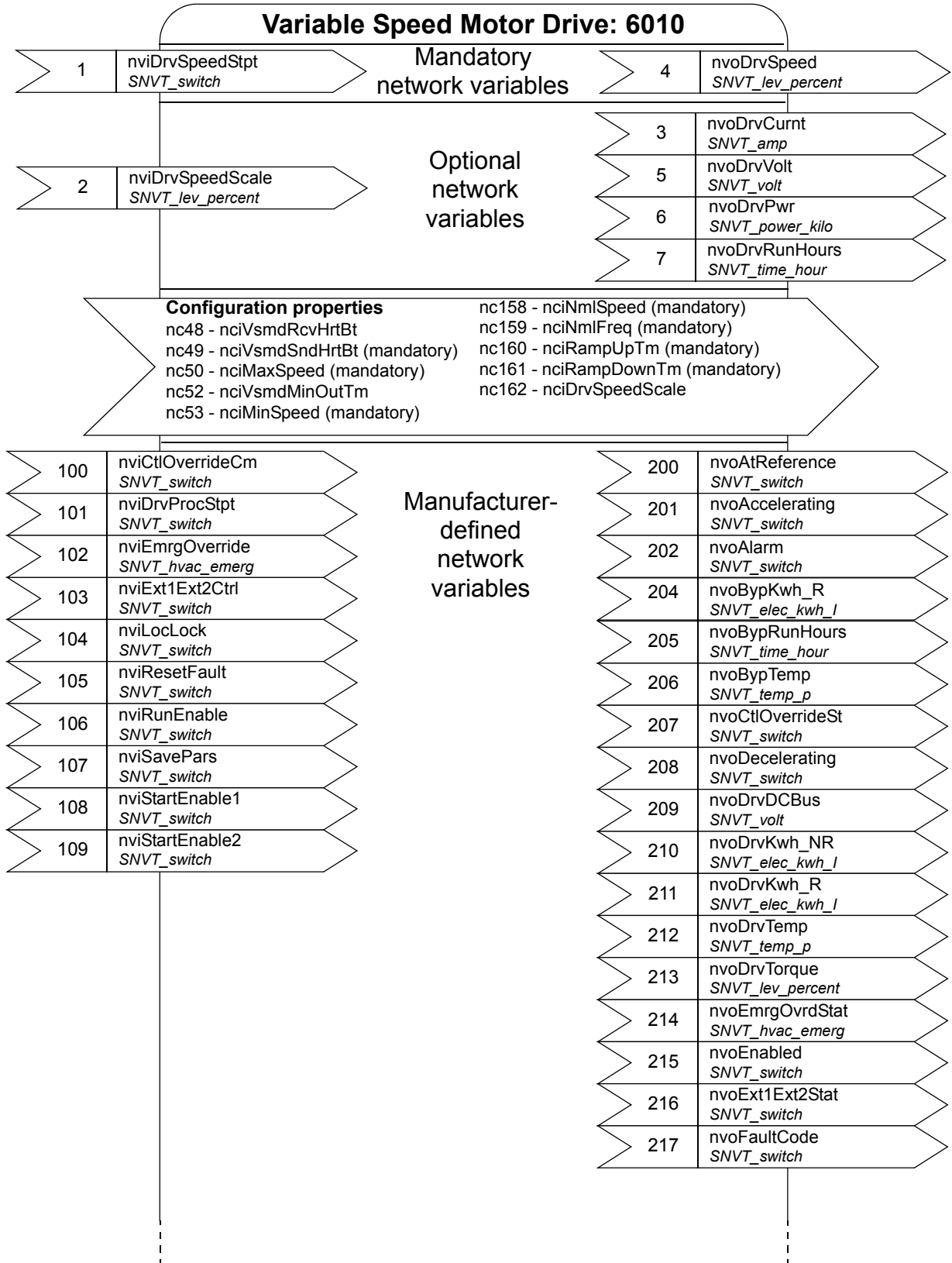

Manufacturer-
defined
network
variables

218	nvoFaulted <i>SNVT_switch</i>
219	nvoForward <i>SNVT_switch</i>
220	nvoFreqAct <i>SNVT_freq_hz</i>
221	nvoLimit <i>SNVT_switch</i>
222	nvoLineVolt <i>SNVT_volt</i>
223	nvoLineUVVolt <i>SNVT_volt</i>
224	nvoLineVWVolt <i>SNVT_volt</i>
225	nvoLineWUVolt <i>SNVT_volt</i>
226	nvoLocRemStat <i>SNVT_switch</i>
227	nvoMtrRevCntM <i>SNVT_count_32</i>
228	nvoMtrTemp <i>SNVT_temp_p</i>
229	nvoNetCtrl <i>SNVT_switch</i>
230	nvoNetRef1 <i>SNVT_switch</i>
231	nvoNetRef2 <i>SNVT_switch</i>
232	nvoParReadValue <i>SNVT_count</i>
233	nvoPid1Dev <i>SNVT_lev_percent</i>
234	nvoPid1Fbk <i>SNVT_lev_percent</i>
235	nvoPid2Dev <i>SNVT_lev_percent</i>
236	nvoPid2Fbk <i>SNVT_lev_percent</i>
237	nvoReady <i>SNVT_switch</i>
238	nvoReverse <i>SNVT_switch</i>
239	nvoRunning <i>SNVT_switch</i>
240	nvoSpeedActRpm <i>SNVT_count_inc</i>
241	nvoStarted <i>SNVT_switch</i>
242	nvoZeroSpeed <i>SNVT_switch</i>

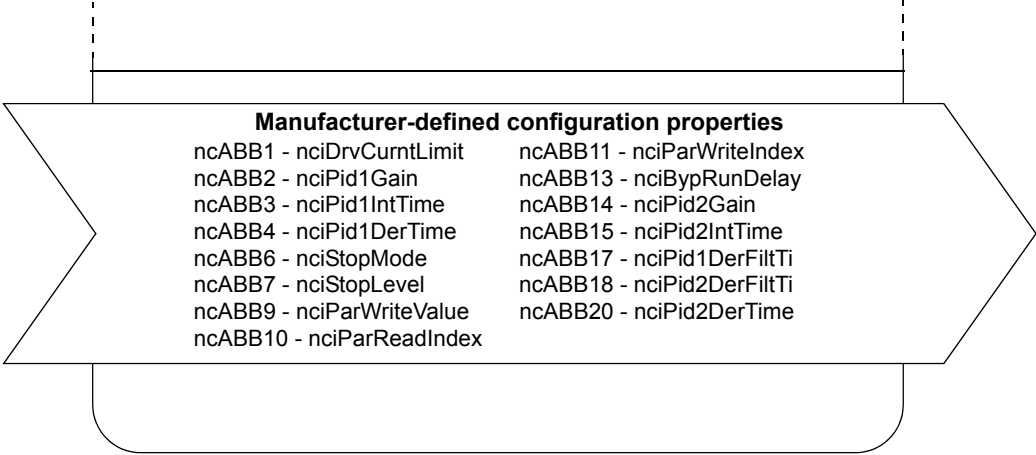

Open loop actuator object: DigitalCommand

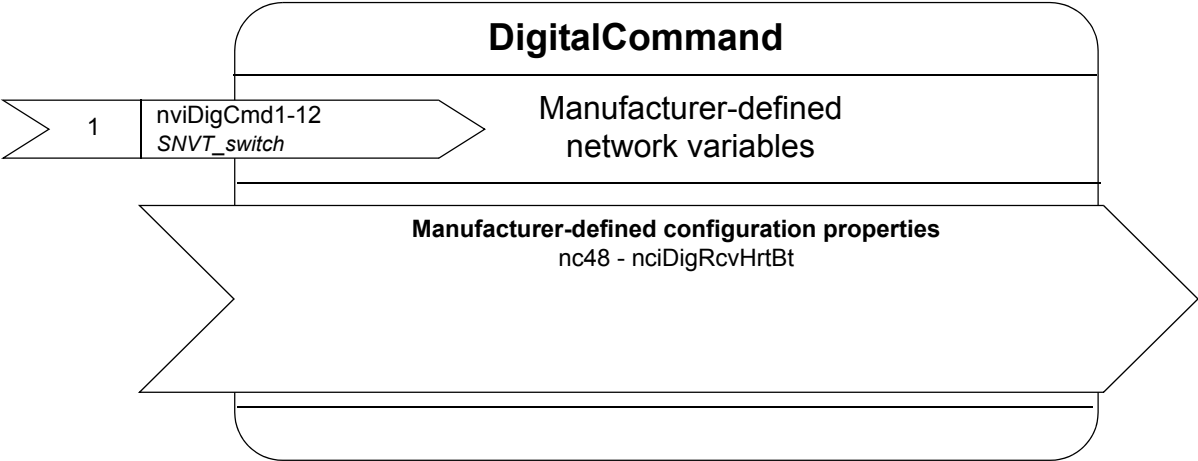

Open loop sensor object: DigitalStatus

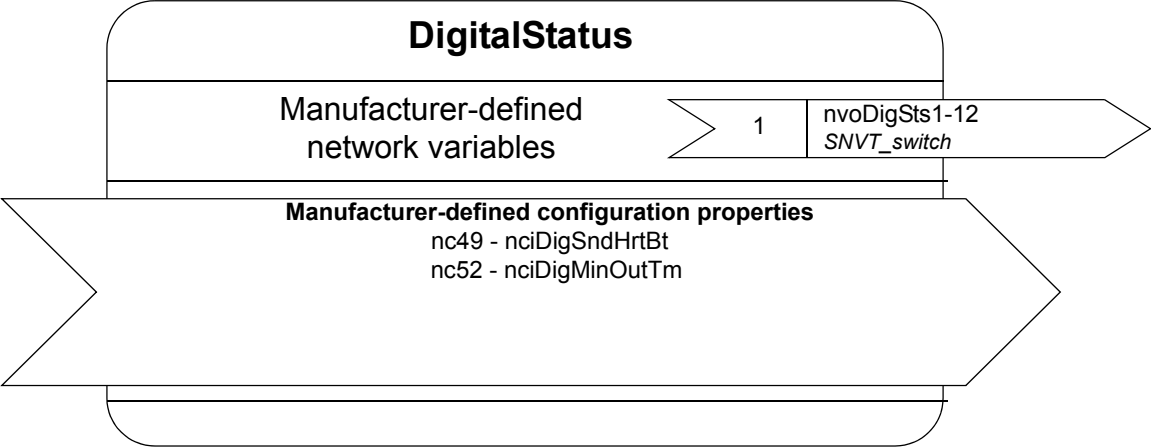

Open loop sensor object: DigitalInput

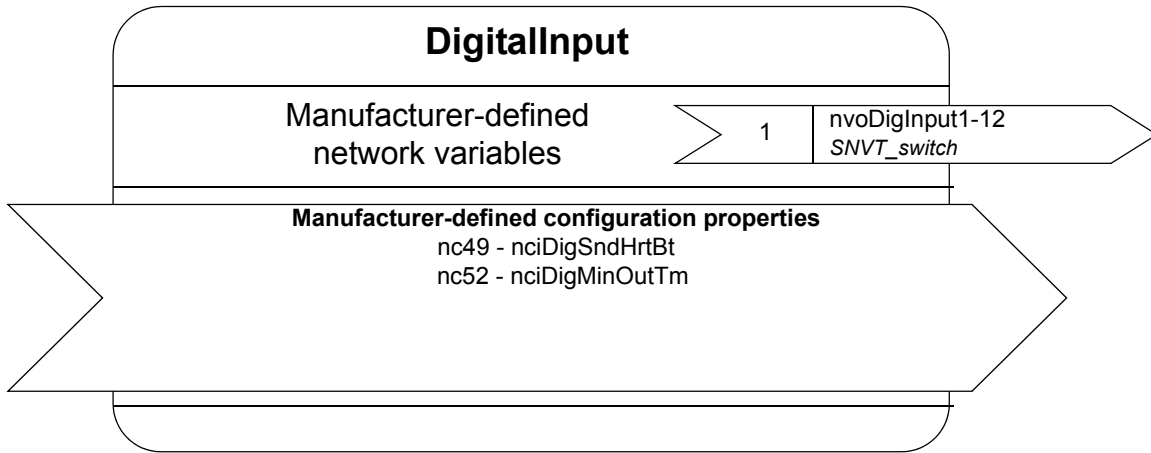

Open loop sensor object: DigitalOutput

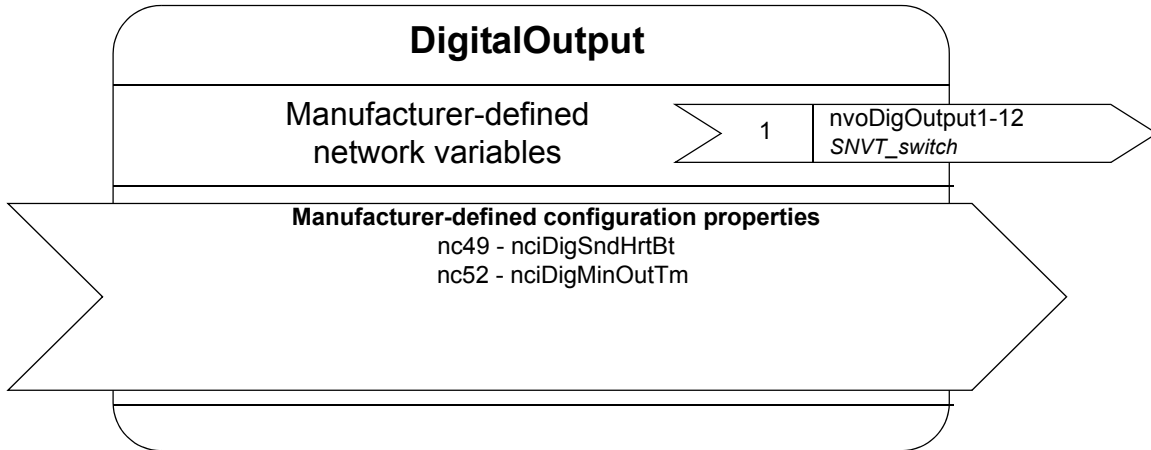

Open loop actuator object: AnalogCmd

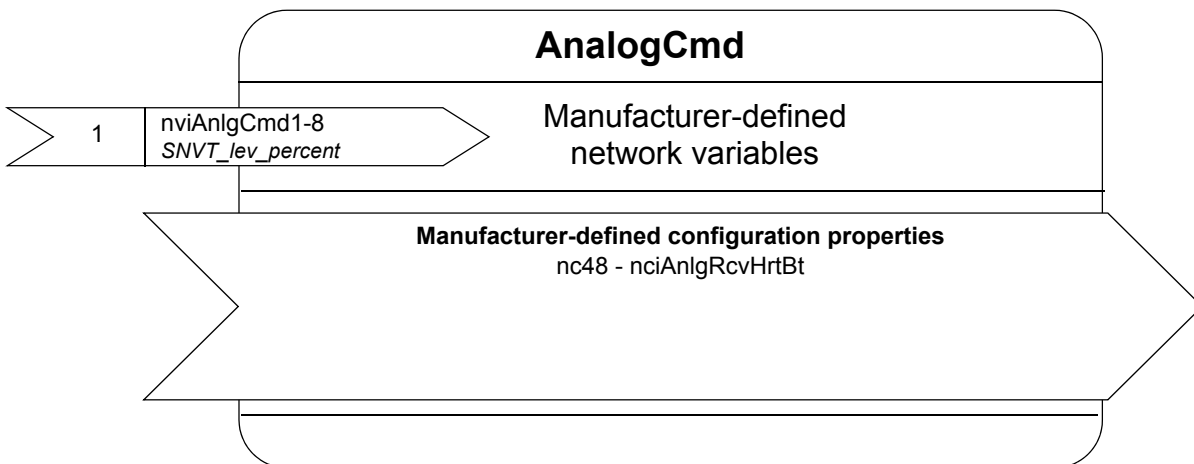

Open loop sensor object: AnalogStatus

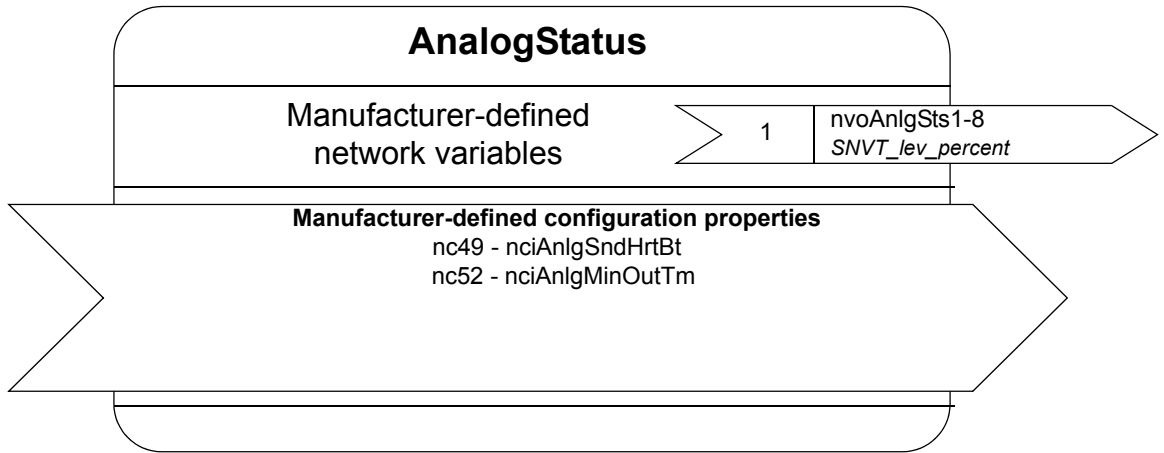

Open loop sensor object: AnalogInput

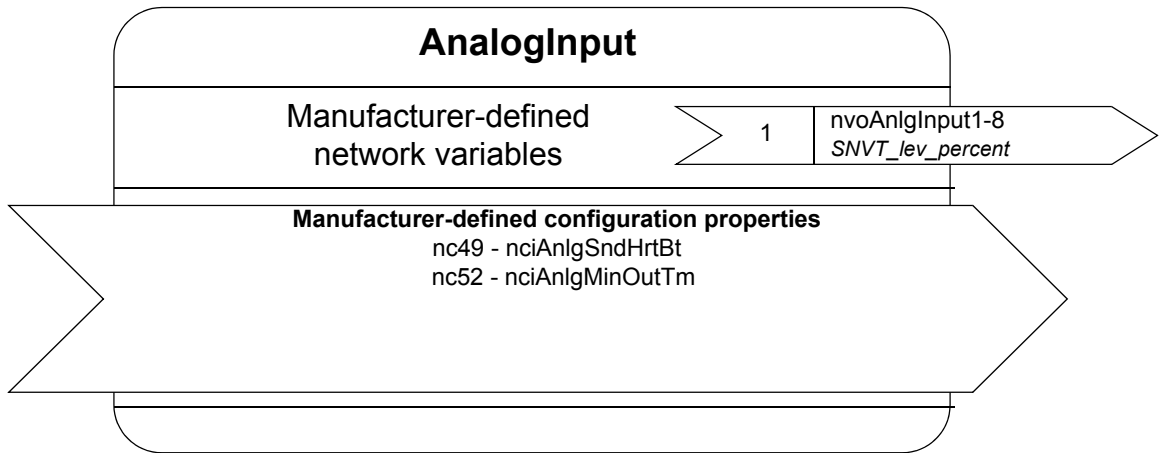

Open loop sensor object: AnalogOutput

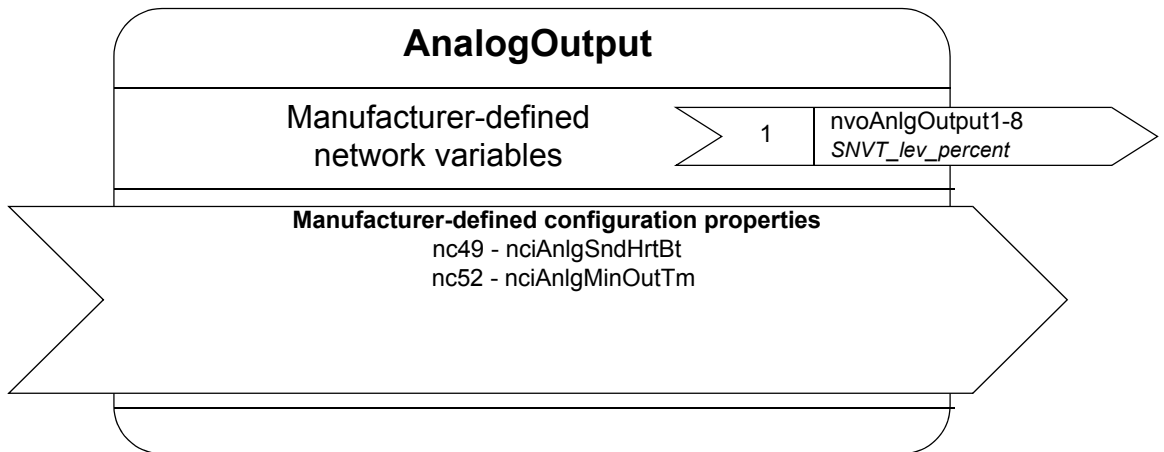

Resource files

For the installation of the adapter module with different installation tools, resource files are needed. If you have not received these files together with the adapter module, consult your local ABB representative or ABB's web site.

The resource files are delivered as a compressed (*.ZIP) archive. Copy the ZIP archive to your "LonWorks" directory and unpack the compressed files.

The directory

LONWORKS\TYPES\USER\ABB\FLON

holds the user type and enumeration file (VSD_FLON01.TYP), the user type formatting file (VSD_FLON01.FMT), the functional profile template file (VSD_FLON01.FPT) and the language file (VSD_FLON01.ENU).

The directory

LONWORKS\IMPORT\ABB\FLON

holds the external interface files (*.XIF):

XIF version 2.0 (e.g. FLON_V20.XIF)

XIF version 3.1 (e.g. FLON_V31.XIF)

XIF version 4.1 (e.g. FLON_V41.XIF)

XIF version 4.4 (e.g. FLON_V44.XIF)

The device interface (XIF) file is a standalone file that documents the device interface for a type of device. It also documents the default values for all the configuration properties on the device. The different XIF files are for the different versions of the LonMaker® tool. The appropriate XIF file version is chosen depending on the installation tool used.

Network variables

Supported input network variables

The actual valid range of a network input variable can be smaller than the one reported in this manual, depending on the drive firmware. Typically the drive discards the parameter changes, if the value coming from the fieldbus is outside the range of the drive parameter. For the list of the network variables that are used with the drives compatible with the adapter module, see chapter [APPENDIX: Compatibility table](#).

Name	Description	More info on page
nviAnlgCmd1 ... nviAnlgCmd8	Supply of analog commands to the host	41
nviCtlOverrideCm	Request for override of control and references sources by the network	42
nviDigCmd1 ... nviDigCmd12	Control of state of digital outputs 1 to 12	43
nviDrvProcStpt	Low-resolution process set point	44
nviDrvSpeedScale	Scaling for nviDrvSpeedStpt	45
nviDrvSpeedStpt	Low-resolution speed set point	46
nviEmrgOverride	Possibility to stop the motor in case of an emergency	47
nviExt1Ext2Ctrl	Sets the control location that should be used (EXT1/EXT2)	48
nviLocLock	Sets local lock on or off	48
nviRequest	Enables control commands and updates from network	49
nviResetFault	Input to the motor to clear the fault status in the drive	50
nviRunEnable	Sets the run enable for the host	51

Name	Description	More info on page
<i>nviSavePars</i>	Request for parameter save to non-volatile memory by network	51
<i>nviStartEnable1</i>	Sets start enable 1 for the host	52
<i>nviStartEnable2</i>	Sets start enable 2 for the host	52

nviAnlgCmd1 ... nviAnlgCmd8

Definition:

Network input SNVT_lev_percent nviAnlgCmd1
 Network input SNVT_lev_percent nviAnlgCmd2
 Network input SNVT_lev_percent nviAnlgCmd3
 Network input SNVT_lev_percent nviAnlgCmd4
 Network input SNVT_lev_percent nviAnlgCmd5
 Network input SNVT_lev_percent nviAnlgCmd6
 Network input SNVT_lev_percent nviAnlgCmd7
 Network input SNVT_lev_percent nviAnlgCmd8

Explanation:

Each variable supplies an analog command (1 ... 8) to the host.
 The configuration and mapping of these points is host-specific.

Valid range:

Value	Analog command
-32768	-163.84%
32766	163.83%
0x7FFF	Invalid

Default value:

The default value is 0%.

nviCtlOverrideCm*Definition:*

Network input SNVT_switch nviCtlOverrideCm

Explanation:

This variable issues a request to override control and reference sources by the network.

Valid range:

State	Value	Override command
0	0%	No override
1	100%	Network overrides control and reference

Default value:

The default value is No override (state 0, value 0%). This value will be adopted at power-up and in case of not receiving an update within the specified Receive Heartbeat time.

nviDigCmd1 ... nviDigCmd12

Definition:

Network input SNVT_switch nviDigCmd1
 Network input SNVT_switch nviDigCmd2
 Network input SNVT_switch nviDigCmd3
 Network input SNVT_switch nviDigCmd4
 Network input SNVT_switch nviDigCmd5
 Network input SNVT_switch nviDigCmd6
 Network input SNVT_switch nviDigCmd7
 Network input SNVT_switch nviDigCmd8
 Network input SNVT_switch nviDigCmd9
 Network input SNVT_switch nviDigCmd10
 Network input SNVT_switch nviDigCmd11
 Network input SNVT_switch nviDigCmd12

Explanation:

Each variable supplies a digital command (1 ... 12) to the host.
 The configuration and mapping of these points is host-specific.

Valid range:

State	Value	Digital command
0	0%	Inactive
1	100%	Active

Default value:

The default value is Inactive (state 0, value 0%).

nviDrvProcStpt*Definition:*

Network input SNVT_switch nviDrvProcStpt

Explanation:

This variable provides start/stop control and a low resolution process set point. It is active when external control location EXT2 is selected.

Valid range:

State	Value	Command
0	Not used	Stop
1	0	0%
1	1 to 200	0.5 to 100.0%
1	201 to 255	100%
0xFF	Not used	AUTO (Invalid)

Default value:

The default value is AUTO (state 0xFF). This value will be adopted at power-up and in case of not receiving an update within the specified Receive Heartbeat time.

nviDrvSpeedScale

Definition:

Network input SNVT_lev_percent nviDrvSpeedScale

Explanation:

This variable provides scaling for *nviDrvSpeedStpt*. For example, if the *nviDrvSpeedStpt* value is 100% and the *nviDrvSpeedScale* value is -150%, then the actual speed set point value is -150% meaning 1.5 times the nominal speed in the reverse direction.

Valid range:

Value	Speed scaling
-32768	-163.840%
32766	163.830%
0x7FFF	Invalid

Default value:

The value is defined by *SCPTdefScale / nciDrvSpeedScale*. This value will be adopted at power-up and in case of not receiving an update within the specified Receive Heartbeat time.

nviDrvSpeedStpt

Definition:

Network input SNVT_switch nviDrvSpeedStpt

Explanation:

This variable provides start/stop control and a low-resolution speed set point for external control location EXT1. The speed set point is the result of multiplication of *nviDrvSpeedStpt* and *nviDrvSpeedScale*. For example, if the value of *nviDrvSpeedStpt* is 100% and the value of *nviDrvSpeedScale* is -150%, the actual speed set point value is -150% meaning 1.5 times nominal speed in the reverse direction.

Valid range:

State	Value	Equivalent percentage	Requested speed
0	Not used	Not used	STOPPED
1	0	0%	0%
1	1 to 100	1 to 100.0%	1 to 100.0%
0xFF	Not used	Not used	AUTO (invalid)

Default value:

The default value is AUTO (state 0xFF). The value will be adapted at power-up and in case of not receiving an update within the specified Receive Heartbeat time.

nviEmrgOverride

Definition:

Network input SNVT_hvac_emerg nviEmrgOverride (HVAC Emergency Mode)

Explanation:

This variable provides the possibility to stop the motor in case of an emergency.

Valid range:

Setting	Function
EMERG_NORMAL	No emergency mode, motor control enabled.
EMERG_PRESSURIZE	See EMERG_NORMAL
EMERG_DEPRESSURIZE	See EMERG_NORMAL
EMERG_PURGE	See EMERG_NORMAL
EMERG_SHUTDOWN	Emergency shutdown mode. Stops motor.
EMERG_FIRE	See EMERG_NORMAL
EMERG_NULL	See EMERG_NORMAL

Default value:

The default value is EMERG_NORMAL. The value will be adapted at power-up and in case of not receiving an update within the specified Receive Heartbeat time.

nviExt1Ext2Ctrl*Definition:*

Network input SNVT_switch nviExt1Ext2Ctrl

Explanation:

This variable sets the external control location (EXT1/EXT2).

Valid range:

State	Value	Control location
0	0%	EXT1
1	100%	EXT2

Default value:

The default value is EXT1 (state 0, value 0%).

nviLocLock*Definition:*

Network input SNVT_switch nviLocLock

Explanation:

This variable sets local lock on or off.

Valid range:

State	Value	Command
0	0%	Local lock is off
1	100%	Local lock is on

Default value:

The default value is Local lock off (state 0, value 0%). This value will be adopted at power-up and in case of not receiving an update within the specified Receive Heartbeat time.

nviRequest

Definition:

Network input SNVT_obj_request nviRequest

Explanation:

This variable enables control commands and updates from the network. The status of the node is reported in nvoStatus.

Valid range:

Object request	Function
RQ_UPDATE_STATU S	Updates nvoStatus.
RQ_CLEAR_STATUS	Clears nvoStatus.
RQ_CLEAR_ALARM	Resets fault in the drive/bypass.
RQ_REPORT_MASK	Reports supported requests in nvoStatus.
RQ_NORMAL	Sets object to default state. (normal request)
RQ_DISABLE	Stops the drive/bypass with the selected stop mode and disables the operation and object.
RQ_ENABLE	Enables the drive for operation and enables the object.

The commands not listed above will be reported as invalid_request in nvoStatus.

nviResetFault*Definition:*

Network input SNVT_switch nviResetFault

Explanation:

This variable clears the fault status in the host.

Valid range:

State	Value	Command
0	0%	Enable reset fault
1	100%	Reset fault

On a transition from 0 to 1, this input network variable clears the fault condition in the drive. Following a fault reset, this variable should be set to 0 to enable the next reset fault.

Default value:

The default value is No action (state 0, value 0%). This value will be adopted at power-up and in case of not receiving an update within the specified Receive Heartbeat time.

nviRunEnable

Definition:

Network input SNVT_switch nviRunEnable

Explanation:

This variable sets the run enable for the host.

Valid range:

State	Value	Command
0	0%	Run disabled
1	100%	Run enabled

Default value:

The default value is Run disabled (state 0, value 0%). This value will be adopted at power-up and in case of not receiving an update within the specified Receive Heartbeat time.

nviSavePars

Definition:

Network input SNVT_switch nviSavePars

Explanation:

This variable indicates that the LONWORKS[®] network requests parameters to be saved to non-volatile memory.

Valid range:

State	Value	Command
0	0%	Do nothing
1	100%	Save parameters

Default value:

The default value is Do nothing (state 0, value 0%). This value will be adopted at power-up.

nviStartEnable1*Definition:*

Network input SNVT_switch nviStartEnable1

Explanation:

This variable sets start enable 1 for the host.

Valid range:

State	Value	Command
0	0%	Start 1 disabled
1	100%	Start 1 enabled

Default value:

The default value is Start 1 disabled (state 0, value 0%). This value will be adopted at power-up and in case of not receiving an update within the specified Receive Heartbeat time.

nviStartEnable2*Definition:*

Network input SNVT_switch nviStartEnable2

Explanation:

This variable sets start enable 2 for the host.

Valid range:

State	Value	Command
0	0%	Start 2 disabled
1	100%	Start 2 enabled

Default value:

The default value is Start 2 disabled (state 0, value 0%). This value will be adopted at power-up and in case of not receiving an update within the specified Receive Heartbeat time.

Supported output network variables

Name	Description	More info on page
nvoAccelerating	Indicates the drive is accelerating	56
nvoAlarm	Indicates the drive has an alarm	57
nvoAnlgInput1 ... nvoAnlgInput8	Status of analog inputs 1 to 8	58
nvoAnlgOutput1 ... nvoAnlgOutput8	Status of analog outputs 1 to 8	59
nvoAnlgSts1 ... nvoAnlgSts8	Analog statuses 1 to 8 from the host	60
nvoAtReference	Indicates the drive is at reference	61
nvoBypKwh_R	Value of the resettable bypass kWh counter *	62
nvoBypRunHours	Operation time for the motor by the bypass in whole hours *	63
nvoBypTemp	Bypass PCB temperature in degrees C *	64
nvoCtlOverrideSt	Indicates that the LonWorks® network has overridden other control and reference sources	65
nvoDecelerating	Indicates the drive is decelerating	66
nvoDigInput1 ... nvoDigInput12	Status of digital inputs 1 to 8	67
nvoDigOutput1 ... nvoDigOutput12	Status of digital outputs 1 to 8	68
nvoDigSts1 ... nvoDigSts12	Digital statuses 1 to 8 from the host	69
nvoDrvCurnt	Drive current in amperes	70
nvoDrvDCBus	Drive DC bus voltage	71
nvoDrvKwh_NR	Value of the non-resettable drive kWh counter	72
nvoDrvKwh_R	Value of the resettable drive kWh counter	73
nvoDrvPwr	Drive power in kilowatts	74

Name	Description	More info on page
<i>nvoDrvRunHours</i>	Operation time for the motor by the drive in whole hours	75
<i>nvoDrvSpeed</i>	Speed of the drive as a percentage of the nominal speed	76
<i>nvoDrvTemp</i>	Temperature in degrees C	77
<i>nvoDrvTorque</i>	Output torque as a percentage of motor nominal torque	78
<i>nvoDrvVolt</i>	Motor output voltage	79
<i>nvoEmrgOvrdStat</i>	Feedback for <i>nviEmrgOverride</i>	80
<i>nvoEnabled</i>	Indicates the drive has received the run enable command	81
<i>nvoExt1Ext2Stat</i>	Control location currently used (EXT1/EXT2)	82
<i>nvoFaultCode</i>	Latest malfunction code that has occurred	83
<i>nvoFaulted</i>	Information on the fault status of the drive	84
<i>nvoForward</i>	Indicates the drive is running in the forward direction	85
<i>nvoFreqAct</i>	Output frequency in Hz	86
<i>nvoLimit</i>	Indicates the drive has reached a speed, frequency or torque limit	87
<i>nvoLineUVVolt,</i> <i>nvoLineVWVolt,</i> <i>nvoLineWUVolt</i>	Line-to-line input voltages in volts	88
<i>nvoLineVolt</i>	Drive input voltage	89
<i>nvoLocRemStat</i>	Control mode (Local or Remote)	90
<i>nvoMtrRevCntM</i>	Accumulated revolutions of the motor in millions	91
<i>nvoMtrTemp</i>	Motor temperature in degrees C	92
<i>nvoNetCtrl</i>	Indicates the LonWorks® network is selected as the active control source	93

Name	Description	More info on page
<i>nvoNetRef1</i>	Indicates the LonWorks® network is selected as the active reference REF1 source	94
<i>nvoNetRef2</i>	Indicates the LonWorks® network is selected as the active reference REF2 source	95
<i>nvoParReadValue</i>	Data read at parameter set by <i>UCPTparReadIndex / nciParReadIndex</i>	96
<i>nvoPid1Dev</i> , <i>nvoPid2Dev</i>	PID controller deviation values	97
<i>nvoPid1Fbk</i> , <i>nvoPid2Fbk</i>	PID controller feedback values	98
<i>nvoReady</i>	Indicates the drive is ready to receive a start command	99
<i>nvoReverse</i>	Indicates the drive is running in the reverse direction	100
<i>nvoRunning</i>	Motor running state	101
<i>nvoSpeedActRpm</i>	Output speed in rpm	102
<i>nvoStarted</i>	Indicates the drive has received a start command	103
<i>nvoStatus</i>	Reports the node object status	104
<i>nvoZeroSpeed</i>	Indicates the drive is at zero speed	105

* not for generic drive use

nvoAccelerating*Definition:*

Network output SNVT_switch nvoAccelerating

Explanation:

This variable indicates that the drive is accelerating.

Valid range:

State	Value	Status
0	0.0%	Not accelerating
1	100.0%	Accelerating

When transmitted:

This value is transmitted immediately when its value has changed significantly. Additionally, this network variable will also be transmitted as a heartbeat output on a regular basis as specified by the Maximum Sent Time (nciVsmdSndHrtBt) configuration value.

Update rate:

This value will be updated no faster than the Minimum Send Time (nciVsmdMinOutTm) configuration value, if used.

nvoAlarm*Definition:*

Network output SNVT_switch nvoAlarm

Explanation:

This variable indicates that the drive has an alarm.

Valid range:

State	Value	Status
0	0.0%	No alarm
1	100.0%	Alarm

When transmitted:

This value is transmitted immediately when its value has changed significantly. Additionally, this network variable will also be transmitted as a heartbeat output on a regular basis as specified by the Maximum Sent Time (nciVsmdSndHrtBt) configuration value.

Update rate:

This value will be updated no faster than the Minimum Send Time (nciVsmdMinOutTm) configuration value, if used.

nvoAnlgInput1 ... nvoAnlgInput8*Definition:*

Network output SNVT_lev_percent nvoAnlgInput1
 Network output SNVT_lev_percent nvoAnlgInput2
 Network output SNVT_lev_percent nvoAnlgInput3
 Network output SNVT_lev_percent nvoAnlgInput4
 Network output SNVT_lev_percent nvoAnlgInput5
 Network output SNVT_lev_percent nvoAnlgInput6
 Network output SNVT_lev_percent nvoAnlgInput7
 Network output SNVT_lev_percent nvoAnlgInput8

Explanation:

Each variable indicates the value of the corresponding analog input (1 ... 8) of the host.

Valid range:

Value	Analog input value
-32768	-163.84%
32766	163.83%
0x7FFF	Invalid

When transmitted:

This value is transmitted immediately when its value has changed significantly. Additionally, this network variable will also be transmitted as a heartbeat output on a regular basis as specified by the Maximum Sent Time (nciVsmdSndHrtBt) configuration value.

Update rate:

This value will be updated no faster than the Minimum Send Time (nciVsmdMinOutTm) configuration value, if used.

nvoAnlgOutput1 ... nvoAnlgOutput8

Definition:

Network output SNVT_lev_percent nvoAnlgOutput1
 Network output SNVT_lev_percent nvoAnlgOutput2
 Network output SNVT_lev_percent nvoAnlgOutput3
 Network output SNVT_lev_percent nvoAnlgOutput4
 Network output SNVT_lev_percent nvoAnlgOutput5
 Network output SNVT_lev_percent nvoAnlgOutput6
 Network output SNVT_lev_percent nvoAnlgOutput7
 Network output SNVT_lev_percent nvoAnlgOutput8

Explanation:

Each variable indicates the value of the corresponding analog output (1 ... 8) of the host.

Valid range:

Value	Analog output value
-32768	-163.84%
32766	163.83%
0x7FFF	Invalid

When transmitted:

This value is transmitted immediately when its value has changed significantly. Additionally, this network variable will also be transmitted as a heartbeat output on a regular basis as specified by the Maximum Sent Time (nciVsmdSndHrtBt) configuration value.

Update rate:

This value will be updated no faster than the Minimum Send Time (nciVsmdMinOutTm) configuration value, if used.

nvoAnlgSts1 ... nvoAnlgSts8*Definition:*

Network output SNVT_lev_percent nvoAnlgSts1
 Network output SNVT_lev_percent nvoAnlgSts2
 Network output SNVT_lev_percent nvoAnlgSts3
 Network output SNVT_lev_percent nvoAnlgSts4
 Network output SNVT_lev_percent nvoAnlgSts5
 Network output SNVT_lev_percent nvoAnlgSts6
 Network output SNVT_lev_percent nvoAnlgSts7
 Network output SNVT_lev_percent nvoAnlgSts8

Explanation:

Each variable indicates an analog status (1 ... 8) from the host.
 The configuration and mapping of these points is host-specific.

Valid range:

Value	Analog status
-32768	-163.84%
32766	163.83%
0x7FFF	Invalid

When transmitted:

This value is transmitted immediately when its value has changed significantly. Additionally, this network variable will also be transmitted as a heartbeat output on a regular basis as specified by the Maximum Sent Time (nciVsmdSndHrtBt) configuration value.

Update rate:

This value will be updated no faster than the Minimum Send Time (nciVsmdMinOutTm) configuration value, if used.

nvoAtReference

Definition:

Network output SNVT_switch nvoAtReference

Explanation:

This variable indicates that the drive is at reference.

Valid range:

State	Value	Status
0	0.0%	Not at reference
1	100.0%	At reference

When transmitted:

This value is transmitted immediately when its value has changed significantly. Additionally, this network variable will also be transmitted as a heartbeat output on a regular basis as specified by the Maximum Sent Time (nciVsmdSndHrtBt) configuration value.

Update rate:

This value will be updated no faster than the Minimum Send Time (nciVsmdMinOutTm) configuration value, if used.

nvoBypKwh_R*Definition:*

Network output SNVT_elec_kwh_I nvoBypKwh_R

Explanation:

This variable provides the value of the resettable bypass kWh counter.

Valid range:

Value	Energy
-2147483648	-214748364.8 kWh
2147483646	214748364.6 kWh
0x7FFFFFFF	Invalid

When transmitted:

This value is transmitted immediately when its value has changed significantly. Additionally, this network variable will also be transmitted as a heartbeat output on a regular basis as specified by the Maximum Sent Time (nciVsmdSndHrtBt) configuration value.

Update rate:

This value will be updated no faster than the Minimum Send Time (nciVsmdMinOutTm) configuration value, if used.

Note: This variable is not meant for generic drive use.

nvoBypRunHours

Definition:

Network output SNVT_time_hour nvoBypRunHours

Explanation:

This variable provides the total operation time for the motor by the bypass in running hours.

Valid range:

Value	Time
0	0.0 h
65534	65534 h
65535	Invalid

When transmitted:

This value is transmitted immediately when its value has changed significantly. Additionally, this network variable will also be transmitted as a heartbeat output on a regular basis as specified by the Maximum Sent Time (nciVsmdSndHrtBt) configuration value.

Update rate:

This value will be updated no faster than the Minimum Send Time (nciVsmdMinOutTm) configuration value, if used.

Note: This variable is not meant for generic drive use.

nvoBypTemp

Definition:

Network output SNVT_temp_p nvoBypTemp

Explanation:

This variable provides the bypass PCB temperature in degrees C.

Valid range:

Value	Temperature
-27317	-273.17 °C
0	0 °C
32767	327.67 °C

When transmitted:

This value is transmitted immediately when its value has changed significantly. Additionally, this network variable will also be transmitted as a heartbeat output on a regular basis as specified by the Maximum Sent Time (nciVsmdSndHrtBt) configuration value.

Update rate:

This value will be updated no faster than the Minimum Send Time (nciVsmdMinOutTm) configuration value, if used.

Note: This variable is not meant for generic drive use.

nvoCtlOverrideSt

Definition:

Network output SNVT_switch nvoCtlOverrideSt

Explanation:

This variable indicates that the LONWORKS® network has overridden other control and reference sources.

Valid range:

State	Value	Control source
0	0.0	Other
1	100.0	Network

When transmitted:

This value is transmitted immediately when its value has changed significantly. Additionally, this network variable will also be transmitted as a heartbeat output on a regular basis as specified by the Maximum Sent Time (nciVsmdSndHrtBt) configuration value.

Update rate:

This value will be updated no faster than the Minimum Send Time (nciVsmdMinOutTm) configuration value, if used.

nvoDecelerating

Definition:

Network output SNVT_switch nvoDecelerating

Explanation:

This variable indicates that the drive is decelerating.

Valid range:

State	Value	Status
0	0.0%	Not decelerating
1	100.0%	Decelerating

When transmitted:

This value is transmitted immediately when its value has changed significantly. Additionally, this network variable will also be transmitted as a heartbeat output on a regular basis as specified by the Maximum Sent Time (nciVsmdSndHrtBt) configuration value.

Update rate:

This value will be updated no faster than the Minimum Send Time (nciVsmdMinOutTm) configuration value, if used.

nvoDigInput1 ... nvoDigInput12

Definition:

Network output SNVT_switch nvoDigInput1
 Network output SNVT_switch nvoDigInput2
 Network output SNVT_switch nvoDigInput3
 Network output SNVT_switch nvoDigInput4
 Network output SNVT_switch nvoDigInput5
 Network output SNVT_switch nvoDigInput6
 Network output SNVT_switch nvoDigInput7
 Network output SNVT_switch nvoDigInput8
 Network output SNVT_switch nvoDigInput9
 Network output SNVT_switch nvoDigInput10
 Network output SNVT_switch nvoDigInput11
 Network output SNVT_switch nvoDigInput12

Explanation:

Each variable indicates the status of the corresponding digital input (1 ... 12) of the host.

Valid range:

State	Value	Digital input status
0	0%	Inactive
1	100%	Active

When transmitted:

This value is transmitted immediately when its value has changed significantly. Additionally, this network variable will also be transmitted as a heartbeat output on a regular basis as specified by the Maximum Sent Time (nciVsmdSndHrtBt) configuration value.

Update rate:

This value will be updated no faster than the Minimum Send Time (nciVsmdMinOutTm) configuration value, if used.

nvoDigOutput1 ... nvoDigOutput12

Definition:

Network output SNVT_switch nvoDigOutput1
 Network output SNVT_switch nvoDigOutput2
 Network output SNVT_switch nvoDigOutput3
 Network output SNVT_switch nvoDigOutput4
 Network output SNVT_switch nvoDigOutput5
 Network output SNVT_switch nvoDigOutput6
 Network output SNVT_switch nvoDigOutput7
 Network output SNVT_switch nvoDigOutput8
 Network output SNVT_switch nvoDigOutput9
 Network output SNVT_switch nvoDigOutput10
 Network output SNVT_switch nvoDigOutput11
 Network output SNVT_switch nvoDigOutput12

Explanation:

Each variable indicates the status of the corresponding digital output (1 ... 12) of the host.

Valid range:

State	Value	Digital output status
0	0%	Inactive
1	100%	Active

When transmitted:

This value is transmitted immediately when its value has changed significantly. Additionally, this network variable will also be transmitted as a heartbeat output on a regular basis as specified by the Maximum Sent Time (nciVsmdSndHrtBt) configuration value.

Update rate:

This value will be updated no faster than the Minimum Send Time (nciVsmdMinOutTm) configuration value, if used.

nvoDigSts1 ... nvoDigSts12

Definition:

Network output SNVT_switch nvoDigSts1
 Network output SNVT_switch nvoDigSts2
 Network output SNVT_switch nvoDigSts3
 Network output SNVT_switch nvoDigSts4
 Network output SNVT_switch nvoDigSts5
 Network output SNVT_switch nvoDigSts6
 Network output SNVT_switch nvoDigSts7
 Network output SNVT_switch nvoDigSts8
 Network output SNVT_switch nvoDigSts9
 Network output SNVT_switch nvoDigSts10
 Network output SNVT_switch nvoDigSts11
 Network output SNVT_switch nvoDigSts12

Explanation:

Each variable indicates a digital status (1 ... 12) from the host. The configuration and mapping of these points is host-specific.

Valid range:

State	Value	Digital status
0	0%	Inactive
1	100%	Active

When transmitted:

This value is transmitted immediately when its value has changed significantly. Additionally, this network variable will also be transmitted as a heartbeat output on a regular basis as specified by the Maximum Sent Time (nciVsmdSndHrtBt) configuration value.

Update rate:

This value will be updated no faster than the Minimum Send Time (nciVsmdMinOutTm) configuration value, if used.

nvoDrvCurnt*Definition:*

Network output SNVT_amp nvoDrvCurnt

Explanation:

This variable provides the drive current in amperes.

Valid Range:

Value	Current
0	0.0 A
32766	3276.6 A
0x7FFF	Invalid

When transmitted:

This value is transmitted immediately when its value has changed significantly. Additionally, this network variable will also be transmitted as a heartbeat output on a regular basis as specified by the Maximum Sent Time (nciVsmdSndHrtBt) configuration value.

Update rate:

This value will be updated no faster than the Minimum Send Time (nciVsmdMinOutTm) configuration value, if used.

nvoDrvDCBus

Definition:

Network output SNVT_volt nvoDrvDCBus

Explanation:

This variable provides the drive DC bus voltage.

Valid range:

Value	Voltage
0	0.0 V
3276.6	3276.6 V
0x7FFF	Invalid

When transmitted:

This value is transmitted immediately when its value has changed significantly. Additionally, this network variable will also be transmitted as a heartbeat output on a regular basis as specified by the Maximum Sent Time (nciVsmdSndHrtBt) configuration value.

Update rate:

This value will be updated no faster than the Minimum Send Time (nciVsmdMinOutTm) configuration value, if used.

nvoDrvKwh_NR*Definition:*

Network output SNVT_elec_kwh_I nvoDrvKwh_NR

Explanation:

This variable provides the value of the non-resettable drive kWh counter.

Valid range:

Value	Energy
-2147483648	-214748364.8 kWh
2147483646	214748364.6 kWh
0x7FFFFFFF	Invalid

When transmitted:

This value is transmitted immediately when its value has changed significantly. Additionally, this network variable will also be transmitted as a heartbeat output on a regular basis as specified by the Maximum Sent Time (nciVsmdSndHrtBt) configuration value.

Update rate:

This value will be updated no faster than the Minimum Send Time (nciVsmdMinOutTm) configuration value, if used.

nvoDrvKwh_R*Definition:*

Network output SNVT_elec_kwh_I nvoDrvKwh_R

Explanation:

This variable provides the value of the resettable drive kWh counter.

Valid range:

Value	Energy
-2147483648	-214748364.8 kWh
2147483646	214748364.6 kWh
0x7FFFFFFF	Invalid

When transmitted:

This value is transmitted immediately when its value has changed significantly. Additionally, this network variable will also be transmitted as a heartbeat output on a regular basis as specified by the Maximum Sent Time (nciVsmdSndHrtBt) configuration value.

Update rate:

This value will be updated no faster than the Minimum Send Time (nciVsmdMinOutTm) configuration value, if used.

nvoDrvPwr*Definition:*

Network output SNVT_power_kilo nvoDrvPwr

Explanation:

This variable provides drive power in kilowatts.

Valid range:

Value	Power
0	0.0 kW
65534	6553.4 kW
65535	Invalid

When transmitted:

This value is transmitted immediately when its value has changed significantly. Additionally, this network variable will also be transmitted as a heartbeat output on a regular basis as specified by the Maximum Sent Time (nciVsmdSndHrtBt) configuration value.

Update rate:

This value will be updated no faster than the Minimum Send Time (nciVsmdMinOutTm) configuration value, if used.

nvoDrvRunHours

Definition:

Network output SNVT_time_hour nvoDrvRunHours

Explanation:

This variable provides the total operation time for the motor by the drive in running hours.

Valid range:

Value	Time
0	0.0 h
65534	65534 h
65535	Invalid

When transmitted:

This value is transmitted immediately when its value has changed significantly. Additionally, this network variable will also be transmitted as a heartbeat output on a regular basis as specified by the Maximum Sent Time (nciVsmdSndHrtBt) configuration value.

Update rate:

This value will be updated no faster than the Minimum Send Time (nciVsmdMinOutTm) configuration value, if used.

nvoDrvSpeed*Definition:*

Network output SNVT_lev_percent nvoDrvSpeed

Explanation:

This variable provides the speed of the drive as a percentage of the nominal speed.

Valid range:

Value	Speed
-32768	-163.84%
32766	163.83%
0x7FFF	Invalid

When transmitted:

This value is transmitted immediately when its value has changed significantly. Additionally, this network variable will also be transmitted as a heartbeat output on a regular basis as specified by the Maximum Sent Time (nciVsmdSndHrtBt) configuration value.

Update rate:

This value will be updated no faster than the Minimum Send Time (nciVsmdMinOutTm) configuration value, if used.

nvoDrvTemp

Definition:

Network output SNVT_temp_p nvoDrvTemp

Explanation:

This variable provides the drive temperature in degrees C.

Valid range:

Value	Temperature
-27317	-273.17 °C
0	0 °C
32767	327.67 °C

When transmitted:

This value is transmitted immediately when its value has changed significantly. Additionally, this network variable will also be transmitted as a heartbeat output on a regular basis as specified by the Maximum Sent Time (nciVsmdSndHrtBt) configuration value.

Update rate:

This value will be updated no faster than the Minimum Send Time (nciVsmdMinOutTm) configuration value, if used.

nvoDrvTorque

Definition:

Network output SNVT_lev_percent nvoDrvTorque

Explanation:

This variable provides output torque as a percentage of motor nominal torque.

Valid range:

Value	Torque
-32768	-163.84%
32766	163.83%
0x7FFF	Invalid

When transmitted:

This value is transmitted immediately when its value has changed significantly. Additionally, this network variable will also be transmitted as a heartbeat output on a regular basis as specified by the Maximum Sent Time (nciVsmdSndHrtBt) configuration value.

Update rate:

This value will be updated no faster than the Minimum Send Time (nciVsmdMinOutTm) configuration value, if used.

nvoDrvVolt*Definition:*

Network output SNVT_volt nvoDrvVolt

Explanation:

This variable provides the motor output voltage.

Valid range:

Value	Voltage
0	0.0 V
3276.6	3276.6 V
0x7FFF	Invalid

When transmitted:

This value is transmitted immediately when its value has changed significantly. Additionally, this network variable will also be transmitted as a heartbeat output on a regular basis as specified by the Maximum Sent Time (nciVsmdSndHrtBt) configuration value.

Update rate:

This value will be updated no faster than the Minimum Send Time (nciVsmdMinOutTm) configuration value, if used.

nvoEmrgOvrStat*Definition:*

Network output SNVT_hvac_emerg nvoEmrgOvrStat

Explanation:

This variable provides feedback for the nviEmrgOverride.

Valid range:

Value	Function
EMERG_NORMAL	No emergency mode, motor control enabled
EMERG_SHUTDOWN	Emergency shutdown mode. Stops motor.
EMERG_NUL	Invalid

When transmitted:

This value is transmitted immediately when its value has changed significantly. Additionally, this network variable will also be transmitted as a heartbeat output on a regular basis as specified by the Maximum Sent Time (nciVsmdSndHrtBt) configuration value.

Update rate:

This value will be updated no faster than the Minimum Send Time (nciVsmdMinOutTm) configuration value, if used.

nvoEnabled*Definition:*

Network output SNVT_switch nvoEnabled

Explanation:

This variable indicates that the drive has received the run enable command.

Valid range:

State	Value	Status
0	0.0%	Not enabled
1	100.0%	Enabled

When transmitted:

This value is transmitted immediately when its value has changed significantly. Additionally, this network variable will also be transmitted as a heartbeat output on a regular basis as specified by the Maximum Sent Time (nciVsmdSndHrtBt) configuration value.

Update rate:

This value will be updated no faster than the Minimum Send Time (nciVsmdMinOutTm) configuration value, if used.

nvoExt1Ext2Stat*Definition:*

Network output SNVT_switch nvoExt1Ext2Stat

Explanation:

This output variable shows the external control location currently used (EXT1 or EXT2).

Valid range:

State	Value	Control location
0	0%	EXT1
1	100%	EXT2

When transmitted:

This value is transmitted immediately when its value has changed significantly. Additionally, this network variable will also be transmitted as a heartbeat output on a regular basis as specified by the Maximum Sent Time (nciVsmdSndHrtBt) configuration value.

Update rate:

This value will be updated no faster than the Minimum Send Time (nciVsmdMinOutTm) configuration value, if used.

nvoFaultCode*Definition:*

Network output SNVT_switch nvoFaultCode

Explanation:

This variable provides the current fault (DRIVECOMM) reported by host.

Valid range:

Value	Fault code
0 ... 65535	DRIVECOMM fault code

When transmitted:

This value is transmitted immediately when its value has changed significantly. Additionally, this network variable will also be transmitted as a heartbeat output on a regular basis as specified by the Maximum Sent Time (nciVsmdSndHrtBt) configuration value.

Update rate:

This value will be updated no faster than the Minimum Send Time (nciVsmdMinOutTm) configuration value, if used.

nvoFaulted*Definition:*

Network output SNVT_switch nvoFaulted

Explanation:

This variable provides information on the fault status of the host.

Valid range:

State	Value	Status
0	0.0	Not faulted
1	100.0	Faulted

When transmitted:

This value is transmitted immediately when its value has changed significantly. Additionally, this network variable will also be transmitted as a heartbeat output on a regular basis as specified by the Maximum Sent Time (nciVsmdSndHrtBt) configuration value.

Update rate:

This value will be updated no faster than the Minimum Send Time (nciVsmdMinOutTm) configuration value, if used.

nvoForward*Definition:*

Network output SNVT_switch nvoForward

Explanation:

This variable indicates that the drive is running in the forward direction.

Valid range:

State	Value	Status
0	0.0%	Not forward
1	100.0%	Forward

When transmitted:

This value is transmitted immediately when its value has changed significantly. Additionally, this network variable will also be transmitted as a heartbeat output on a regular basis as specified by the Maximum Sent Time (nciVsmdSndHrtBt) configuration value.

Update rate:

This value will be updated no faster than the Minimum Send Time (nciVsmdMinOutTm) configuration value, if used.

nvoFreqAct*Definition:*

Network output SNVT_freq_hz nvoFreqAct

Explanation:

This variable shows output frequency in Hz.

Valid range:

Value	Frequency
0	0.0 Hz
65535	6553.5 Hz

When transmitted:

This value is transmitted immediately when its value has changed significantly. Additionally, this network variable will also be transmitted as a heartbeat output on a regular basis as specified by the Maximum Sent Time (nciVsmdSndHrtBt) configuration value.

Update rate:

This value will be updated no faster than the Minimum Send Time (nciVsmdMinOutTm) configuration value, if used.

nvoLimit*Definition:*

Network output SNVT_switch nvoLimit

Explanation:

This variable indicates that the drive has reached a speed, frequency or torque limit.

Valid range:

State	Value	Status
0	0.0%	Within limits
1	100.0%	Out of limits

When transmitted:

This value is transmitted immediately when its value has changed significantly. Additionally, this network variable will also be transmitted as a heartbeat output on a regular basis as specified by the Maximum Sent Time (nciVsmdSndHrtBt) configuration value.

Update rate:

This value will be updated no faster than the Minimum Send Time (nciVsmdMinOutTm) configuration value, if used.

nvoLineUVVolt, nvoLineVWVolt, nvoLineWUVolt*Definition:*

Network output SNVT_volt nvoLineUVVolt
 Network output SNVT_volt nvoLineVWVolt
 Network output SNVT_volt nvoLineWUVolt

Explanation:

Each variable provides the corresponding line-to-line input voltage in volts.

Valid range:

Value	Voltage
0	0.0 V
3276.6	3276.6 V
0x7FFF	Invalid

When transmitted:

This value is transmitted immediately when its value has changed significantly. Additionally, this network variable will also be transmitted as a heartbeat output on a regular basis as specified by the Maximum Sent Time (nciVsmdSndHrtBt) configuration value.

Update rate:

This value will be updated no faster than the Minimum Send Time (nciVsmdMinOutTm) configuration value, if used.

nvoLineVolt*Definition:*

Network output SNVT_volt nvoLineVolt

Explanation:

This variable provides the drive input voltage in volts.

Valid range:

Value	Voltage
0	0.0 V
3276.6	3276.6 V
0x7FFF	Invalid

When transmitted:

This value is transmitted immediately when its value has changed significantly. Additionally, this network variable will also be transmitted as a heartbeat output on a regular basis as specified by the Maximum Sent Time (nciVsmdSndHrtBt) configuration value.

Update rate:

This value will be updated no faster than the Minimum Send Time (nciVsmdMinOutTm) configuration value, if used.

nvoLocRemStat*Definition:*

Network output SNVT_switch nvoLocRemStat

Explanation:

This output variable shows if the drive is in the Local or Remote control mode.

Valid range:

State	Value	Control mode
0	0%	Local
1	100%	Remote

When transmitted:

This value is transmitted immediately when its value has changed significantly. Additionally, this network variable will also be transmitted as a heartbeat output on a regular basis as specified by the Maximum Sent Time (nciVsmdSndHrtBt) configuration value.

Update rate:

This value will be updated no faster than the Minimum Send Time (nciVsmdMinOutTm) configuration value, if used.

nvoMtrRevCntM*Definition:*

Network output SNVT_count_32 nvoMtrRevCntM

Explanation:

This variable shows accumulated revolutions of the motor in millions.

Valid range:

Value	Motor revolutions
0	0
1	1,000,000
4294967295	4,294,967,295,000,000

When transmitted:

This value is transmitted immediately when its value has changed significantly. Additionally, this network variable will also be transmitted as a heartbeat output on a regular basis as specified by the Maximum Sent Time (nciVsmdSndHrtBt) configuration value.

Update rate:

This value will be updated no faster than the Minimum Send Time (nciVsmdMinOutTm) configuration value, if used.

nvoMtrTemp*Definition:*

Network output SNVT_temp_p nvoMtrTemp

Explanation:

This variable provides the motor temperature in degrees C.

Valid range:

Value	Temperature
-27317	-273.17 °C
0	0 °C
32767	327.67 °C

When transmitted:

This value is transmitted immediately when its value has changed significantly. Additionally, this network variable will also be transmitted as a heartbeat output on a regular basis as specified by the Maximum Sent Time (nciVsmdSndHrtBt) configuration value.

Update rate:

This value will be updated no faster than the Minimum Send Time (nciVsmdMinOutTm) configuration value, if used.

nvoNetCtrl

Definition:

Network output SNVT_switch nvoNetCtrl

Explanation:

This variable indicates that the LONWORKS[®] network is selected as the active control source.

Valid range:

State	Value	Control source
0	0.0%	Other
1	100.0%	Network

When transmitted:

This value is transmitted immediately when its value has changed significantly. Additionally, this network variable will also be transmitted as a heartbeat output on a regular basis as specified by the Maximum Sent Time (nciVsmdSndHrtBt) configuration value.

Update rate:

This value will be updated no faster than the Minimum Send Time (nciVsmdMinOutTm) configuration value, if used.

nvoNetRef1*Definition:*

Network output SNVT_switch nvoNetRef1

Explanation:

This variable indicates that the LONWORKS[®] network is selected as the active reference REF1 source.

Valid range:

State	Value	Reference Source
0	0.0%	Other
1	100.0%	Network

When transmitted:

This value is transmitted immediately when its value has changed significantly. Additionally, this network variable will also be transmitted as a heartbeat output on a regular basis as specified by the Maximum Sent Time (nciVsmdSndHrtBt) configuration value.

Update rate:

This value will be updated no faster than the Minimum Send Time (nciVsmdMinOutTm) configuration value, if used.

nvoNetRef2*Definition:*

Network output SNVT_switch nvoNetRef2

Explanation:

This variable indicates that the LONWORKS[®] network is selected as the active reference REF2 source.

Valid range:

State	Value	Reference Source
0	0.0%	Other
1	100.0%	Network

When transmitted:

This value is transmitted immediately when its value has changed significantly. Additionally, this network variable will also be transmitted as a heartbeat output on a regular basis as specified by the Maximum Sent Time (nciVsmdSndHrtBt) configuration value.

Update rate:

This value will be updated no faster than the Minimum Send Time (nciVsmdMinOutTm) configuration value, if used.

nvoParReadValue

Definition:

Network output SNVT_count nvoParReadValue

Explanation:

This variable contains the value read from the parameter set by [UCPTparReadIndex / nciParReadIndex](#).

Valid range:

Value	Parameter value
0 ... 65534	Parameter-dependent
0xFFFF	Invalid

When transmitted:

This value is transmitted immediately when its value has changed significantly. Additionally, this network variable will also be transmitted as a heartbeat output on a regular basis as specified by the Maximum Sent Time (nciVsmdSndHrtBt) configuration value.

Update rate:

This value will be updated no faster than the Minimum Send Time (nciVsmdMinOutTm) configuration value, if used.

nvoPid1Dev, nvoPid2Dev*Definition:*

Network output SNVT_lev_percent nvoPID1Dev

Network output SNVT_lev_percent nvoPID2Dev

Explanation:

This variable shows the PID controller deviation values.

Valid range:

Value	Feedback
-32768	-163.84%
32766	163.83%
32767	Invalid

When transmitted:

This value is transmitted immediately when its value has changed significantly. Additionally, this network variable will also be transmitted as a heartbeat output on a regular basis as specified by the Maximum Sent Time (nciVsmdSndHrtBt) configuration value.

Update rate:

This value will be updated no faster than the Minimum Send Time (nciVsmdMinOutTm) configuration value, if used.

nvoPid1Fbk, nvoPid2Fbk*Definition:*

Network output SNVT_lev_percent nvoPid1Fbk

Network output SNVT_lev_percent nvoPid2Fbk

Explanation:

This variable shows the PID controller feedback values.

Valid range:

Value	Feedback
-32768	-163.84%
32766	163.83%
32767	Invalid

When transmitted:

This value is transmitted immediately when its value has changed significantly. Additionally, this network variable will also be transmitted as a heartbeat output on a regular basis as specified by the Maximum Sent Time (nciVsmdSndHrtBt) configuration value.

Update rate:

This value will be updated no faster than the Minimum Send Time (nciVsmdMinOutTm) configuration value, if used.

nvoReady*Definition:*

Network output SNVT_switch nvoReady

Explanation:

This variable indicates that the drive is ready to receive a start command.

Valid range:

State	Value	Status
0	0.0%	Not ready
1	100.0%	Ready

When transmitted:

This value is transmitted immediately when its value has changed significantly. Additionally, this network variable will also be transmitted as a heartbeat output on a regular basis as specified by the Maximum Sent Time (nciVsmdSndHrtBt) configuration value.

Update rate:

This value will be updated no faster than the Minimum Send Time (nciVsmdMinOutTm) configuration value, if used.

nvoReverse*Definition:*

Network output SNVT_switch nvoReverse

Explanation:

This variable indicates that the drive is running in the reverse direction.

Valid range:

State	Value	Status
0	0.0%	Not reverse
1	100.0%	Reverse

When transmitted:

This value is transmitted immediately when its value has changed significantly. Additionally, this network variable will also be transmitted as a heartbeat output on a regular basis as specified by the Maximum Sent Time (nciVsmdSndHrtBt) configuration value.

Update rate:

This value will be updated no faster than the Minimum Send Time (nciVsmdMinOutTm) configuration value, if used.

nvoRunning

Definition:

Network output SNVT_switch nvoRunning

Explanation:

This variable indicates the motor running state.

Valid range:

State	Value	Status
0	0.0%	Not running
1	100.0%	Running

When transmitted:

This value is transmitted immediately when its value has changed significantly. Additionally, this network variable will also be transmitted as a heartbeat output on a regular basis as specified by the Maximum Sent Time (nciVsmdSndHrtBt) configuration value.

Update rate:

This value will be updated no faster than the Minimum Send Time (nciVsmdMinOutTm) configuration value, if used.

nvoSpeedActRpm*Definition:*

Network output SNVT_count_inc nvoSpeedActRpm

Explanation:

This variable shows output speed in rpm.

Valid range:

Value	Speed
-32768	-32767 rpm
32767	32767 rpm

When transmitted:

This value is transmitted immediately when its value has changed significantly. Additionally, this network variable will also be transmitted as a heartbeat output on a regular basis as specified by the Maximum Sent Time (nciVsmdSndHrtBt) configuration value.

Update rate:

This value will be updated no faster than the Minimum Send Time (nciVsmdMinOutTm) configuration value, if used.

nvoStarted*Definition:*

Network output SNVT_switch nvoStarted

Explanation:

This variable indicates that the drive has received a start command.

Valid range:

State	Value	Status
0	0.0%	Not started
1	100.0%	Started

When transmitted:

This value is transmitted immediately when its value has changed significantly. Additionally, this network variable will also be transmitted as a heartbeat output on a regular basis as specified by the Maximum Sent Time (nciVsmdSndHrtBt) configuration value.

Update rate:

This value will be updated no faster than the Minimum Send Time (nciVsmdMinOutTm) configuration value, if used.

nvoStatus*Definition:*

Network output SNVT_obj_status nvoStatus

Explanation:

This variable reports the node object status.

Valid range:

Bit settings	Description/Function
invalid_id	Invalid node ID requested
report_mask	Reporting supported fields
disabled	RQ_DISABLE active
electrical_fault	Fault bit in Status word
in_alarm	Alarm bit in Status word

nvoZeroSpeed*Definition:*

Network output SNVT_switch nvoZeroSpeed

Explanation:

This variable indicates that the drive is at zero speed.

Valid range:

State	Value	Status
0	0.0%	Not at zero speed
1	100.0%	At zero speed

When transmitted:

This value is transmitted immediately when its value has changed significantly. Additionally, this network variable will also be transmitted as a heartbeat output on a regular basis as specified by the Maximum Sent Time (nciVsmdSndHrtBt) configuration value.

Update rate:

This value will be updated no faster than the Minimum Send Time (nciVsmdMinOutTm) configuration value, if used.

Supported network configuration properties

All configuration properties are defined as configuration network variables in this product. Some network management tools will show these variables as SCPT/UCPT configuration properties and some as network configuration variables. The difference in the network management tools only affects the presentation of the variables but not their functionality.

Name	Description	More info on page
SCPTdefScale / nciDrvSpeedScale	Default value for nviDrvSpeedScale	109
SCPTlocation / nciLocation	Location label	109
SCPTmaxRcvTime / nciAnlgRcvHrtBt	Defines the maximum time after the last update of nviAnlgCmd1 ... nviAnlgCmd8 .	110
SCPTmaxRcvTime / nciDigRcvHrtBt	Defines the maximum time after the last update of nviDigCmd1 ... nviDigCmd12 .	111
SCPTmaxRcvTime / nciVsmdRcvHrtBt	Defines the maximum allowed update interval for input network variables nviDrvSpeedStpt and nviDrvSpeedScale	112
SCPTmaxSendTime / nciAnlgSndHrtBt	Maximum time that expires before network variables nvoAnlgSts1 ... nvoAnlgSts8 , nvoAnlgInput1 ... nvoAnlgInput8 , nvoAnlgOutput1 ... nvoAnlgOutput8 will automatically be updated.	113
SCPTmaxSendTime / nciDigSndHrtBt	Maximum time that expires before network variables nvoDigSts1 ... nvoDigSts12 , nvoDigInput1 ... nvoDigInput12 , nvoDigOutput1 ... nvoDigOutput12 will automatically be updated.	114
SCPTmaxSendTime / nciVsmdSndHrtBt	Maximum send time for the variable nvoDrvSpeed	115
SCPTmaxSetpoint / nciMaxSpeed	Defines the maximum motor speed	116

Name	Description	More info on page
SCPTminSendTime / nciAnlgMinOutTm	Defines the minimum wait time before network output variables nvoAnlgSts1 ... nvoAnlgSts8 , nvoAnlgInput1 ... nvoAnlgInput8 , nvoAnlgOutput1 ... nvoAnlgOutput8 can be propagated (resent).	117
SCPTminSendTime / nciDigMinOutTm	Defines the minimum wait time before network output variables nvoDigSts1 ... nvoDigSts12 , nvoDigInput1 ... nvoDigInput12 , nvoDigOutput1 ... nvoDigOutput12 can be propagated (resent).	118
SCPTminSendTime / nciVsmdMinOutTm	Defines the minimum wait time before the network output variables can be propagated (resent)	119
SCPTminSetpoint / nciMinSpeed	Defines the minimum speed of the motor as a percentage of the nominal speed defined by the Nominal Speed (SCPTnomRPM / nciNmISpeed) configuration value	120
SCPTnomFreq / nciNmIFreq	Sets the nominal frequency of the motor	121
SCPTnomRPM / nciNmISpeed	Sets the nominal motor speed	122
SCPTrampDownTm / nciRampDownTm	Sets the ramp down time of the drive	123
SCPTrampUpTm / nciRampUpTm	Sets the ramp up time of the drive	123
UCPTbypRunDelay / nciByRunDelay	Additional pick-up delay for bypass contactor *	124
UCPTdrvCurntLimit / nciDrvCurntLimit	Drive current limit	124
UCPTparReadIndex / nciParReadIndex	Chooses the parameter value to be read from the drive	125

Name	Description	More info on page
<i>UCPTparValue / nciParWriteValue</i>	Value input for the user selected parameter <i>UCPTparWriteIndex / nciParWriteIndex</i>	125
<i>UCPTparWriteIndex / nciParWriteIndex</i>	Defines the parameter value to be written to the drive	126
<i>UCPTpid1DerFiltTime / nciPid1DerFiltTi, UCPTpid2DerFiltTime / nciPid2DerFiltTi</i>	PID controller derivation filter times in seconds	127
<i>UCPTpid1DerTime / nciPid1DerTime, UCPTpid2DerTime / nciPid2DerTime</i>	PID controller derivation times in seconds	128
<i>UCPTpid1Gain / nciPid1Gain, UCPTpid2Gain / nciPid2Gain</i>	PID controller gain values in percent	129
<i>UCPTpid1IntTime / nciPid1IntTime, UCPTpid2IntTime / nciPid2IntTime</i>	PID controller integration times in seconds	130
<i>UCPTstopLevel / nciStopLevel</i>	Stop level value in the ramp stop mode	131
<i>UCPTstopMode / nciStopMode</i>	Selects between coast and ramp stop	132

* not for generic drive use

SCPTdefScale / nciDrvSpeedScale

Definition:

Network input config SNVT_lev_percent nciDrvSpeedScale

Explanation:

This variable shows the default value for [nviDrvSpeedScale](#).

Valid range:

Value	Speed scaling
-32768	-163.840%
32766	163.830%
32767	Invalid

Default value:

The default value is 100%.

SCPTlocation / nciLocation

Definition:

Network input config SNVT_str_asc nciLocation

Explanation:

This variable provides Location Label; used to provide more descriptive physical location information than can be provided by the Neuron Chip's 6-byte location string.

Valid range:

Any NULL terminated ASCII string of 31 characters.

Default value:

The default value is empty spaces.

SCPTmaxRcvTime / nciAnlgRcvHrtBt*Definition:*

Network config input SNVT_time_sec nciAnlgRcvHrtBt

Explanation:

This variable controls the maximum time that elapses after the last update of *nviAnlgCmd1 ... nviAnlgCmd8* before the default values are used.

Valid range:

Value	Time
0	Disabled
1	0.1 s
65534	6553.4 s
65535	Invalid

Default value:

The default value is 0 (no failure detect).

SCPTmaxRcvTime / nciDigRcvHrtBt*Definition:*

Network config input SNVT_time_sec nciDigRcvHrtBt

Explanation:

This variable controls the maximum time that elapses after the last update of *nviDigCmd1 ... nviDigCmd12* before the default values are used.

Valid range:

Value	Time
0	Disabled
1	0.1 s
65534	6553.4 s
65535	Invalid

Default value:

The default value is 0 (no failure detect).

SCPTmaxRcvTime / nciVsmdRcvHrtBt*Definition:*

Network config input SNVT_time_sec nciVsmdRcvHrtBt

Explanation:

This variable controls the maximum time that elapses after the last update of the network variables before the VSMD object starts to use its default values.

Valid range:

Value	Time
0	Disabled
1	0.1 s
65534	6553.4 s
65535	Invalid

Default value:

The default value is 0 (no failure detect).

SCPTmaxSendTime / nciAnlgSndHrtBt*Definition:*

Network config input SNVT_time_sec nciAnlgSndHrtBt

Explanation:

This variable defines the maximum period of time that expires before network variables *nvoAnlgSts1 ... nvoAnlgSts8*, *nvoAnlgInput1 ... nvoAnlgInput8*, *nvoAnlgOutput1 ... nvoAnlgOutput8* will automatically be updated.

Valid range:

Value	Time
0	No automatic update
1	0.1 s
65534	6553.4 s
65535	Invalid

Default value:

The default value is 0 (no automatic update).

SCPTmaxSendTime / nciDigSndHrtBt*Definition:*

Network config input SNVT_time_sec nciDigSndHrtBt

Explanation:

This variable defines the maximum period of time that expires before network variables *nvoDigSts1 ... nvoDigSts12*, *nvoDigInput1 ... nvoDigInput12*, *nvoDigOutput1 ... nvoDigOutput12* will automatically be updated.

Valid range:

Value	Time
0	No automatic update
1	0.1 s
65534	6553.4 s
65535	Invalid

Default value:

The default value is 0 (no automatic update).

SCPTmaxSendTime / nciVsmdSndHrtBt*Definition:*

Network config input SNVT_time_sec nciVsmdSndHrtBt

Explanation:

This variable defines the maximum period of time that expires before the network variables will automatically be updated.

Valid range:

Value	Time
0	No automatic update
1	0.1 s
65534	6553.4 s
65535	Invalid

Default value:

The default value is 300 (automatic update every 5 minutes).

SCPTmaxSetpoint / nciMaxSpeed

Definition:

Network config input SNVT_lev_percent nciMaxSpeed

Explanation:

This variable is used to define the maximum motor speed. The value is entered as a percent of nominal speed, as defined by the Nominal Speed (*SCPTnomRPM / nciNmISpeed*) configuration value.

The value of the maximum speed must be defined so that

$$-163.840 \leq \text{minimum speed} \leq \text{maximum speed} \leq 163.830$$

Valid range:

Value	Maximum speed
-32768	-163.840%
32766	163.830%
32767	Invalid

Default value:

The default value is read from the host on power-up.

SCPTminSendTime / nciAnlgMinOutTm*Definition:*

Network config input SNVT_time_sec nciAnlgMinOutTm

Explanation:

This variable defines the minimum wait time before network output variables *nvoAnlgSts1 ... nvoAnlgSts8*, *nvoAnlgInput1 ... nvoAnlgInput8*, *nvoAnlgOutput1 ... nvoAnlgOutput8* can be propagated (resent).

Valid range:

Value	Time
0	Disabled
1	0.1 s
65534	6553.4 s
65535	Invalid

Default value:

The default value is 0.5 s.

SCPTminSendTime / nciDigMinOutTm*Definition:*

Network config input SNVT_time_sec nciDigMinOutTm

Explanation:

This variable defines the minimum wait time before network output variables *nvoDigSts1 ... nvoDigSts12, nvoDigInput1 ... nvoDigInput12, nvoDigOutput1 ... nvoDigOutput12* can be propagated (resent).

Valid range:

Value	Time
0	Disabled
1	0.1 s
65534	6553.4 s
65535	Invalid

Default value:

The default value is 0.5 s.

SCPTminSendTime / nciVsmdMinOutTm*Definition:*

Network config input SNVT_time_sec nciVsmdMinOutTm

Explanation:

This variable defines the minimum wait time before the network output variables can be propagated (resent).

Valid range:

Value	Time
0	Disabled
1	0.1 s
65534	6553.4 s
65535	Invalid

Default value:

The default value is 15 s.

SCPTminSetpoint / nciMinSpeed*Definition:*

Network config input SNVT_lev_percent nciMinSpeed

Explanation:

This variable defines the minimum speed of the motor as a percentage of the nominal speed defined by the Nominal Speed (*SCPTnomRPM / nciNmlSpeed*) configuration value.

The value of the minimum speed must be defined so that

$-163.840 \leq \text{minimum speed} \leq \text{maximum speed} \leq 163.830$

Valid range:

Value	Minimum speed
-32768	-163.840%
32766	163.830%
32767	Invalid

Default value:

The default value is read from host on power-up.

SCPTnomFreq / nciNmlFreq*Definition:*

Network config input SNVT_freq_hz nciNmlFreq

Explanation:

This variable provides the nominal frequency of the motor in Hz.

Valid range:

Value	Nominal frequency
0	0 Hz
100	100 Hz

Default value:

The default value is read from the host on power-up/refresh.

SCPTnomRPM / nciNmISpeed*Definition:*

Network config input SNVT_rpm nciNmISpeed

Explanation:

This variable provides the nominal motor speed in rpm. This value is necessary to determine the minimum and maximum speed for the motor, based on the configuration properties

[SCPTminSetpoint / nciMinSpeed](#) and [SCPTmaxSetpoint / nciMaxSpeed](#).

Valid range:

Value	Nominal speed
0	0 rpm
65534	65534 rpm
65535	Invalid

Default value:

The default is read from the host on power-up/refresh.

SCPTrampDownTm / nciRampDownTm*Definition:*

Network config input SNVT_time_sec nciRampDownTm

Explanation:

This variable provides the ramp down time of the motor.

Valid range:

Value	Ramp down time
0	0.0 s
65534	6553.4 s
65535	Invalid

Default value:

The default value is read from the host on power-up/refresh.

SCPTrampUpTm / nciRampUpTm*Definition:*

Network config input SNVT_time_sec nciRampUpTm

Explanation:

This variable provides the ramp up time of the motor.

Valid range:

Value	Ramp up time
0	0.0 s
65534	6553.4 s
65535	Invalid

Default value:

The default is read from the host on power-up/refresh.

UCPTbypRunDelay / nciBypRunDelay*Definition:*

Network input config SNVT_time_sec nciBypRunDelay

Explanation:

This sets the additional pick-up delay for the bypass contactor.

Valid Range:

Value	Pick-up delay
0	Disabled
1	0.1 s
65534	6553.4 s
65535	Invalid

Default Value:

The default is read from the host on power-up/refresh.

Note: This variable is not meant for generic drive use.

UCPTdrvCurntLimit / nciDrvCurntLimit*Definition:*

Network input config SNVT_amp nciDrvCurntLimit

Explanation:

This variable sets the drive output current limit in amperes.

Valid Range:

Value	Current limit
0	0.0 A
32766	3276.6 A
0x7FFF	Invalid

Default Value:

The default value is read from the host on power-on/refresh.

UCPTparReadIndex / nciParReadIndex*Definition:*

Network config input SNVT_count nciParReadIndex

Explanation:

This variable contains the parameter to read for [nvoParReadValue](#).

Valid range:

Value	Parameter value
0 ... 65535	Parameter-dependent

Default value:

The default value is 0.

UCPTparValue / nciParWriteValue*Definition:*

Network config input SNVT_count_inc nciParWriteValue

Explanation:

This variable contains the value to be written to the parameter set by [UCPTparWriteIndex / nciParWriteIndex](#).

Valid range:

Value	Parameter value
0 ... 65534	Parameter-dependent
0xFFFF	Invalid

Default value:

The default value is 0.

UCPTparWriteIndex / nciParWriteIndex*Definition:*

Network config input SNVT_count nciParWriteIndex

Explanation:

This variable contains the parameter to write for *UCPTparValue / nciParWriteValue*.

Valid range:

Value	Parameter value
0 ... 65535	Parameter-dependent

Default value:

The default value is 0.

**UCPTpid1DerFiltTime / nciPid1DerFiltTi,
UCPTpid2DerFiltTime / nciPid2DerFiltTi***Definition:*

Network config input SNVT_time_sec nciPid1DerFiltTi

Network config input SNVT_time_sec nciPid2DerFiltTi

Explanation:

This variable shows the PID controller derivation filter times in seconds.

Valid range:

Value	Filter time
0	0 s
1	0.1 s
65535	6553.5 s
65537	Invalid

Default value:

The default value is read from the host on power-on/refresh.

**UCPTpid1DerTime / nciPid1DerTime,
UCPTpid2DerTime / nciPid2DerTime***Definition:*

Network config input SNVT_time_sec nciPid1DerTime

Network config input SNVT_time_sec nciPid2DerTime

Explanation:

This variable shows the PID controller derivation times in seconds.

Valid range:

Value	Derivation time
0	0 s
1	0.1 s
65535	6553.5 s
65537	Invalid

Default value:

The default value is read from the host on power-on/refresh.

UCPTpid1Gain / nciPid1Gain, UCPTpid2Gain / nciPid2Gain*Definition:*

Network config input SNVT_lev_percent nciPid1Gain

Network config input SNVT_lev_percent nciPid2Gain

Explanation:

This variable provides the PID controller gain values.

Valid Range:

Value	Gain
-32768	-163.84%
32766	163.83%
32767	Invalid

Default Value:

The default is read from the host on power-on/refresh.

**UCPTpid1IntTime / nciPid1IntTime,
UCPTpid2IntTime / nciPid2IntTime***Definition:*

Network config input SNVT_time_sec nciPid1IntTime

Network config input SNVT_time_sec nciPid2IntTime

Explanation:

This variable shows the PID controller integration times in seconds.

Valid range:

Value	Time
0	0 s
1	0.1 s
65535	6553.5 s
65537	Invalid

Default value:

The default is read from the host on power-on/refresh.

UCPTstopLevel / nciStopLevel

Definition:

Network config input SNVT_lev_percent nciStopLevel

Explanation:

This variable provides the stop level value in the ramp stop mode. When the speed of the drive reaches this level, a coast stop is performed. The value corresponds to *nvoDrvSpeed*, ie, the value of 5% causes a coast stop when *nvoDrvSpeed* reaches 5%.

Valid range:

Value	Stop level
-32768	-163.84%
32766	163.83%
32767	Invalid

Default value:

The default value is 5%.

UCPTstopMode / nciStopMode*Definition:*

Network config input SNVT_switch nciStopMode

Explanation:

This variable is used to select between coast and ramp stop.

Valid range:

State	Value	Stop mode
0	0.0	Coast
1	100	Ramp

Default value:

The default value is Coast (state 0, value 0.0).

Diagnostics

LED indications

The adapter module is equipped with three bicolour diagnostic LEDs. The LEDs are described below.

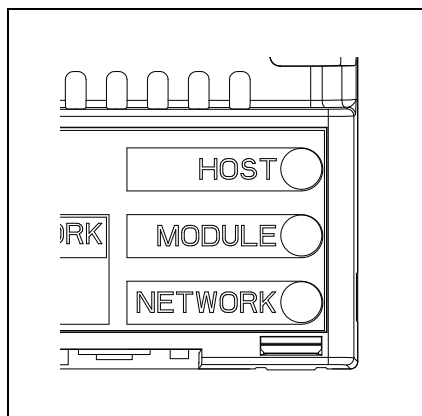

Name	Colour	Function
HOST	Green	Connection to host OK
	Flashing red	Establishing communication to host, or communication to host lost
MODULE	Off	Off/Initializing/Invalid
	Red	Unconfigured (with or without application)
	Yellow	Configured – offline (hard, soft or bypass)
	Flashing yellow	Configured – online (with receive timeout)
	Flashing green	Wink
	Green	Configured – online
NETWORK	Yellow	Transmitting
	Green	Receiving
	Off	Inactive

Technical data

FLON-01

Enclosure:

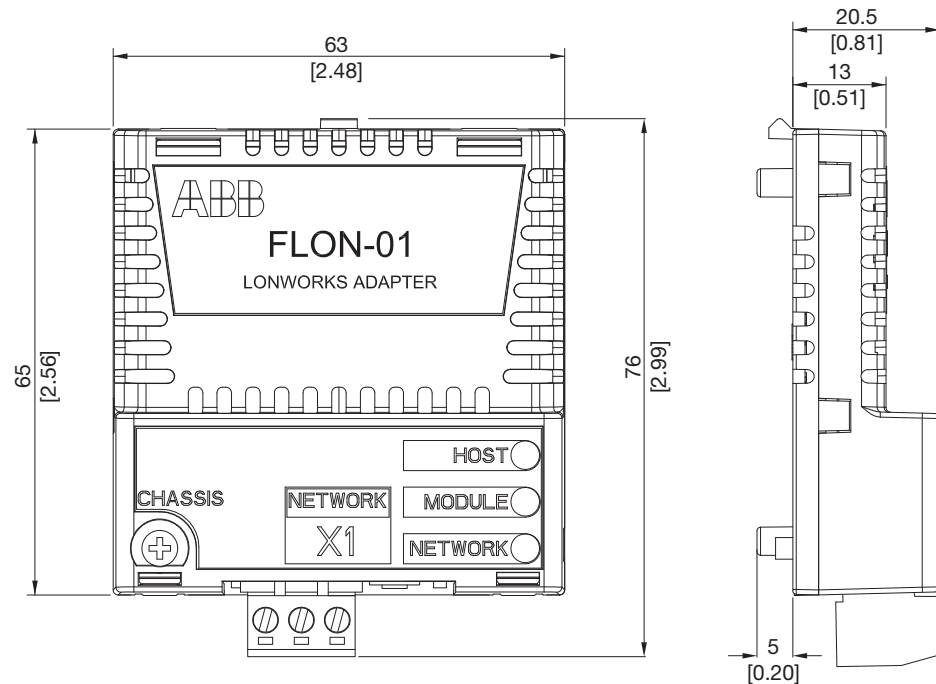

Mounting: Into the option slot on the drive

Degree of protection: IP20

Ambient conditions: The applicable ambient conditions specified for the drive in its manuals are in effect.

Indicators: Three bicolour LEDs (HOST, MODULE, NETWORK)

Connectors:

- 20-pin connector to drive (X2)
- 3-pole detachable screw terminal block (X1)

Power supply:

- +3.3 V \pm 5% max 450 mA (supplied by the drive)

General:

- Estimated min. lifetime: 100 000 h
- All materials UL/CSA-approved
- Complies with EMC standards EN 61000-6-4:2001 and EN 61800-3
- Bus interface functionally isolated from drive

LONWORKS® network**FLON-01 compatible devices:**

All devices equipped with FT-X1 and FTT-10A compatible transceivers

Size of the network:

32385 nodes divided into 127 nodes / subnet with 255 subnets / domain

Medium:

- Termination: 105 Ω / 52.5 Ω , depending on the network topology. See [Bus termination](#) on page 22.
- Cable specifications: See the following tables.

LONWORKS® network cable specifications				
	Control / signalling grade 16 AWG (1.3 mm)	General purpose grade 16 AWG (1.3 mm)	Data grade level 4 22 AWG (0.65 mm)	JY (St) Y 2×2×0.8 20.4 AWG (0.8 mm)
Max DC resistance at 20 °C loop	28.2 Ω/km	28.2 Ω/km	118 Ω/km	74.0 Ω/km
Max DC resistance unbalance			5%	
Max mutual capacitance of a pair	58 nF/km	74 nF/km	56 nF/km	100 nF/km
Max pair-to-ground capacitance unbalance			3.28 nF/km	
Nominal impedance	95 Ω at 1.0 MHz	100 Ω at 1.0 MHz	102 Ω ±15% at 772 kHz 100 Ω ±15% at 1, 4, 8, 10, 16 and 20 MHz	
Max attenuation at 20 °C			15 dB/km at 772 kHz 18 dB/km at 1.0 MHz 36 dB/km at 4.0 MHz 49 dB/km at 8.0 MHz 56 dB/km at 10.0 MHz 72 dB/km at 16.0 MHz 79 dB/km at 20.0 MHz	
Pair twists per metre	20 (nominal)	20 (minimum)		5 (minimum)

LONWORKS® network cable specifications				
	Control / signalling grade 16 AWG (1.3 mm)	General purpose grade 16 AWG (1.3 mm)	Data grade level 4 22 AWG (0.65 mm)	JY (St) Y 2×2×0.8 20.4 AWG (0.8 mm)
Cable parameters	single twisted pair stranded 19/29 unshielded Tefzel Insulation & Jacket High 150 °C max	single twisted pair stranded 19/29 unshielded PVC Insulation & Jacket Medium 80 °C max	twisted pair, single or multiple typically solid and unshielded	wire pair: red/black per DIN VDE 0815 4-wire helical twist solid shielded

LONWORKS® network, maximum bus lengths					
		Control / signalling grade 16 AWG (1.3 mm)	General purpose grade 16 AWG (1.3 mm)	Data grade level 4 22 AWG (0.65 mm)	JY (St) Y 2×2×0.8 20.4 AWG (0.8 mm)
Doubly terminated bus topology	Bus length	2200 m	2200 m	1150 m	750 m
	Stub length	3 m	3 m	3 m	3 m
Singly-terminated free topology	Node-to-node distance	500 m	400 m	400 m	320 m
	Total wire length	500 m	500 m	500 m	500 m

Topology:

Supports free topology wiring, and will accommodate bus, star, loop, or any combination of these topologies

Serial communication type:

Asynchronous, half duplex

Transfer rate:

78 kbit/s

Protocol:

LonTalk®

Documents:

LONMARK® Layers 1-6 Interoperability Guidelines, version 3.4

Definitions and abbreviations

Communication Module

Communication Module is a parameter name/parameter selection name for a device (eg, a fieldbus adapter) through which the drive is connected to an external serial communication network (eg, a fieldbus). The communication with the communication module is activated by a parameter.

CRC

Cyclic Redundancy Check

FLON-01

A device through which an ABB drive is connected to a LONWORKS® network.

Functional profile

Functional profiles may contain one or more objects that interact to perform the required profile defined operability. The Variable Speed Motor Drive Profile contains the general LONMARK® Node Object, application-specific Variable Speed Motor Drive Object, and the Open Loop Sensor and Open Loop Actuator objects.

LonMark®

Products that conform to LONMARK® Interoperability Guidelines, defined by the LONMARK® Interoperability Association, are eligible to carry the LONMARK® logo.

LonTalk®

The communication protocol in LONWORKS® networks

LSB

Least significant bit

MSB

Most significant bit

nci

Network configuration variable

Neuron® ID

Every LONWORKS® device or – as synonym – node must have a unique ID. This is called the Neuron® ID. This ID is, on Neuron® Chip-based nodes, stored in the chip itself and cannot be changed.

nv

Network variable

nvi

Input network variable

nvo

Output network variable

Object

An object is a set of one or more network variables implemented as SNVTs with semantic definitions relating the behaviour of the object to the network variable values, in addition to a set of configuration properties. For example, the Variable Speed Motor Drive Object and the Node Object represent two types of objects.

Parameter

A parameter is an operating instruction for the drive. Parameters can be read and programmed by using the drive control panel, or through the adapter module.

Service Pin

The Service Pin is used in installing the node. Pressing the Service Pin causes the LONWORKS® node to send the so-called Service Pin Message which includes, among other things, the Neuron® ID. This informs the network or installation tool about the node. Holding the Service Pin for more than 10 seconds forces the module to "Go Unconfigured".

SNVT

Standard Network Variable Type

UCPT

User Configuration Property Type

APPENDIX: Compatibility table

Supported network variables in alphabetical order

The following table lists the network variables that are used with the drives compatible with the adapter module.

Note: Bypass Firmware version (bypass parameter 3301) 1.01B or later is required with E-Clipse + ACH550.

Network variable	E-Clipse + ACH550	ACS355	ACS850/ACQ810
nciAnlgMinOutTm	x		x
nciAnlgRcvHrtBt	x		x
nciAnlgSndHrtBt	x		x
nciBypRunDelay	x		
nciDigMinOutTm	x		x
nciDigRcvHrtBt	x		x
nciDigSndHrtBt	x		x
nciDrvCurmtLimit	x		x
nciDrvSpeedScale	x	x	x
nciLocation	x	x	x
nciMaxSpeed	x		x
nciMinSpeed	x		x
nciNmlFreq	x	x	x
nciNmlSpeed	x	x	x
nciParReadIndex	x	x	x
nciParWriteIndex	x	x	x
nciParWriteValue	x	x	x
nciPid1DerFiltTi	x		x
nciPid1DerTime	x		x
nciPid1Gain	x		x
nciPid1IntTime	x		x
nciPid2DerFiltTi	x		
nciPid2DerTime	x		

Network variable	E-Clipse + ACH550	ACS355	ACS850/ACQ810
nciPid2Gain	x		
nciPid2IntTime	x		
nciRampDownTm	x	x	x
nciRampUpTm	x	x	x
nciStopLevel	x	x	x
nciStopMode	x	x	x
nciVsmdMinOutTm	x	x	x
nciVsmdRcvHrtBt	x	x	x
nciVsmdSndHrtBt	x	x	x
nviAnlgCmd_1	x		
nviAnlgCmd_2	x		
nviAnlgCmd_3	x		
nviAnlgCmd_4	x		
nviAnlgCmd_5	x		
nviAnlgCmd_6	x		
nviAnlgCmd_7	x		
nviAnlgCmd_8			
nviCtlOverrideCm	x	x	x
nviDigCmd_1	x		
nviDigCmd_10	x		
nviDigCmd_11	x		
nviDigCmd_12	x		
nviDigCmd_2	x		
nviDigCmd_3	x		
nviDigCmd_4	x		
nviDigCmd_5	x		
nviDigCmd_6	x		
nviDigCmd_7	x		
nviDigCmd_8	x		
nviDigCmd_9	x		
nviDrvProcStpt	x	x	x
nviDrvSpeedScale	x	x	x
nviDrvSpeedStpt	x	x	x

Network variable	E-Clipse + ACH550	ACS355	ACS850/ACQ810
nviEmrgOvrD	x	x	x
nviExt1Ext2Ctrl	x	x	x
nviLocLock	x	x	
nviRequest	x	x	x
nviResetFault	x	x	x
nviRunEnable	x	x	x
nviSavePars	x	x	x
nviStartEnable1	x	x	
nviStartEnable2	x	x	
nvoAccelerating	x	x	
nvoAlarm	x	x	x
nvoAnlgInput_1	x		
nvoAnlgInput_2	x		
nvoAnlgInput_3			
nvoAnlgInput_4			
nvoAnlgInput_5			
nvoAnlgInput_6			
nvoAnlgInput_7			
nvoAnlgInput_8			
nvoAnlgOutput_1	x		
nvoAnlgOutput_2	x		
nvoAnlgOutput_3			
nvoAnlgOutput_4			
nvoAnlgOutput_5			
nvoAnlgOutput_6			
nvoAnlgOutput_7			
nvoAnlgOutput_8			
nvoAnlgSts_1	x		
nvoAnlgSts_2	x		
nvoAnlgSts_3	x		
nvoAnlgSts_4			
nvoAnlgSts_5			
nvoAnlgSts_6			

Network variable	E-Cclipse + ACH550	ACS355	ACS850/ACQ810
nvoAnlgSts_7			
nvoAnlgSts_8			
nvoAtReference	x	x	x
nvoBypKwh_R	x		
nvoBypRunHours	x		
nvoBypTemp	x		
nvoCtlOverrideSt	x	x	x
nvoDecelerating	x	x	
nvoDigInput_1	x		
nvoDigInput_10	x		
nvoDigInput_11	x		
nvoDigInput_12	x		
nvoDigInput_2	x		
nvoDigInput_3	x		
nvoDigInput_4	x		
nvoDigInput_5	x		
nvoDigInput_6	x		
nvoDigInput_7	x		
nvoDigInput_8	x		
nvoDigInput_9	x		
nvoDigOutput_1	x		
nvoDigOutput_10			
nvoDigOutput_11			
nvoDigOutput_12			
nvoDigOutput_2	x		
nvoDigOutput_3	x		
nvoDigOutput_4	x		
nvoDigOutput_5	x		
nvoDigOutput_6	x		
nvoDigOutput_7	x		
nvoDigOutput_8	x		
nvoDigOutput_9			
nvoDigSts_1	x		

Network variable	E-Clipse + ACH550	ACS355	ACS850/ACQ810
nvoDigSts_10			
nvoDigSts_11			
nvoDigSts_12			
nvoDigSts_2	x		
nvoDigSts_3			
nvoDigSts_4			
nvoDigSts_5			
nvoDigSts_6			
nvoDigSts_7			
nvoDigSts_8			
nvoDigSts_9			
nvoDrvCurnt	x	x	x
nvoDrvDCBus	x	x	x
nvoDrvKwh_NR	x	x	
nvoDrvKwh_R	x		x
nvoDrvPwr	x	x	x
nvoDrvRunHours	x	x	x
nvoDrvSpeed	x	x	x
nvoDrvTemp	x	x	
nvoDrvTorque	x	x	x
nvoDrvVolt	x	x	
nvoEmrgOvrdStat	x	x	x
nvoEnabled	x	x	x
nvoExt1Ext2Stat	x	x	x
nvoFaultCode	x	x	x
nvoFaulted	x	x	x
nvoForward	x	x	x
nvoFreqAct	x	x	x
nvoLimit	x	x	x
nvoLineUVVolt	x		
nvoLineVolt	x		
nvoLineWUVolt	x		
nvoLineVWVolt	x		

Network variable	E-Clipse + ACH550	ACS355	ACS850/ACQ810
nvoLocRemStat	x	x	x
nvoMtrRevCntM	x		
nvoMtrTemp	x	x	x
nvoNetCtrl	x	x	x
nvoNetRef1	x	x	
nvoNetRef2	x	x	
nvoParReadValue	x	x	x
nvoPid1Dev	x		x
nvoPid1Fbk	x		x *
nvoPid2Dev	x		
nvoPid2Fbk	x		
nvoReady	x	x	x
nvoReverse	x	x	x
nvoRunning	x	x	x
nvoSpeedActRpm	x	x	x
nvoStarted	x	x	x
nvoStatus	x	x	x
nvoZeroSpeed	x	x	x

* not supported by ACQ810



3AUA0000041017 REV B EN
EFFECTIVE: 28.04.2010

ABB Oy

Drives
P.O. Box 184
FIN-00381 HELSINKI
FINLAND
Telephone +358 10 22 11
Fax +358 10 22 22681
Internet www.abb.com/drives

ABB Inc.

Automation Technologies
Drives & Motors
16250 West Glendale Drive
New Berlin, WI 53151
USA
Telephone 262 785-3200
1-800-HELP-365
Fax 262 780-5135
Internet www.abb.com/drives

**ABB Beijing Drive
Systems Co. Ltd.**

No. 1, Block D,
A-10 Jiuxianqiao Beilu
Chaoyang District
Beijing, P.R. CHINA, 100015
Telephone +86 10 5821 7788
Fax +86 10 5821 7618
Internet www.abb.com/drives