

---

## Instruction Manual

---

# IMO Jaguar VXR

## PG Interface Cards “VXR-EFC” & “VXR-EFC-5V”

---

### CAUTION

Thank you for purchasing our EFC interface card.

- Read through this instruction manual and be familiar with the option card before proceeding with installation, connections (wiring), operation, or maintenance and inspection.
- Deliver this manual to the end user of this product. Keep this manual in a safe place until this product is discarded.
- Specifications of this option card are subject to change without prior notice for improvement.

---

**IMO Precision Controls Ltd.**

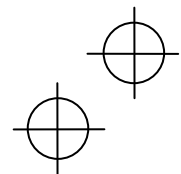
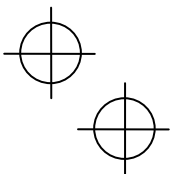

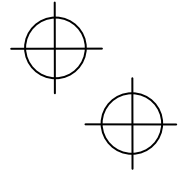
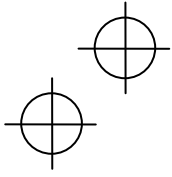

Copyright © 2006. IMO Precision Controls Ltd.

All rights reserved.

No part of this publication may be reproduced or copied without prior written permission from IMO Precision Controls Ltd.

All products and company names mentioned in this manual are trademarks or registered trademarks of their respective holders.

The information contained herein is subject to change without prior notice for improvement.

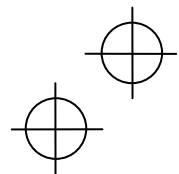
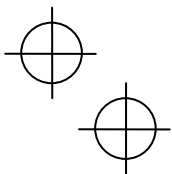

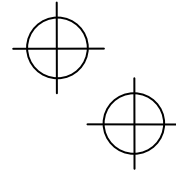
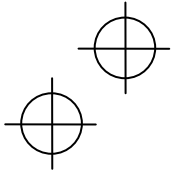

## Preface

Thank you for purchasing our EFC interface card "VXR-EFC."

Mounting this optional card into your Jaguar VXR inverter enables speed control with EFC (e.g. V/f control with EFC and dynamic torque vector control with EFC), pulse train input and positioning control.



Read through this instruction manual in conjunction with the Jaguar VXR Instruction Manual and be familiar with proper handling and operation of this product. Improper handling might result in incorrect operation, a short life, or even a failure of this product.

This instruction manual does not contain inverter handling instructions. Refer to the Jaguar VXR Instruction Manual, and keep this manual in a safe place.

### ■ Safety precautions

Read this manual thoroughly before proceeding with installation, connections (wiring), operation, or maintenance and inspection. Ensure you have sound knowledge of the device and familiarize yourself with all safety information and precautions before proceeding to operate the inverter.

Safety precautions are classified into the following two categories in this manual.

 <b>WARNING</b>	Failure to heed the information indicated by this symbol may lead to dangerous conditions, possibly resulting in death or serious bodily injuries.
 <b>CAUTION</b>	Failure to heed the information indicated by this symbol may lead to dangerous conditions, possibly resulting in minor or light bodily injuries and/or substantial property damage.

Failure to heed the information contained under the CAUTION title can also result in serious consequences. These safety precautions are of utmost importance and must be observed at all times.

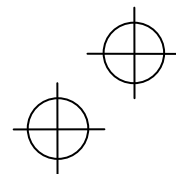
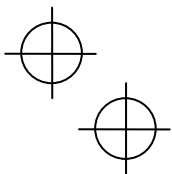

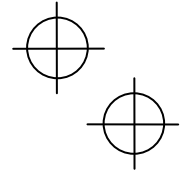
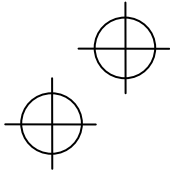

### Installation and wiring

#### **WARNING**

- Turn the inverter's power OFF and wait for at least five minutes before starting installation and wiring.
- Qualified electricians should carry out wiring.  
**Otherwise, electric shock could occur.**

#### **CAUTION**

- Do not use the product that is damaged or lacking parts.  
**Doing so could cause failure or injuries.**
- Prevent lint, paper fibers, sawdust, dust, metallic chips, or other foreign materials from getting into the inverter.  
**Otherwise, a fire or an accident might result.**
- Incorrect handling in installation/removal jobs could cause a failure.  
**A failure might result.**
- Noise may be emitted from the inverter, motor and wires. Implement appropriate measure to prevent the nearby sensors and devices from malfunctioning due to such noise.  
**Otherwise, an accident could occur.**

### Operation

#### **WARNING**

- Be sure to install the terminal cover before turning the power ON.  
Do not remove the cover while the power is on.  
**Doing so could cause electric shock.**
- Confirm and adjust the setting of the function codes before running the inverter.  
**Otherwise, an accident could occur.**

### Maintenance and inspection, and parts replacement

#### **WARNING**

- Turn the power OFF and wait for at least five minutes before starting inspection or parts replacement.  
**Otherwise, electric shock could occur**
- Maintenance, inspection, and parts replacement should be made only by qualified persons.
- Take off the watch, rings and other metallic objects before starting work.
- Use insulated tools.  
**Otherwise, electric shock or injuries could occur.**

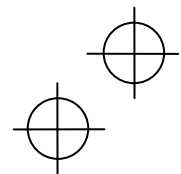
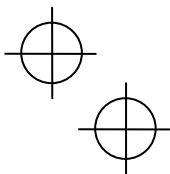

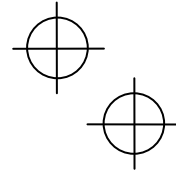
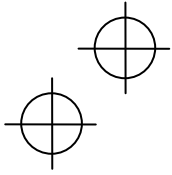

### Disposal

#### **CAUTION**

- Treat the EFC interface card as an industrial waste when disposing of it.  
**Otherwise injuries could occur.**

### Others

#### **WARNING**

- Never attempt to modify the EFC interface card or inverter.  
**Doing so could cause electric shock or injuries.**

### Icons

The following icons are used throughout this manual.



This icon indicates information which, if not heeded, can result in the inverter not operating to full efficiency, as well as information concerning incorrect operations and settings which can result in accidents.



This icon indicates information that can prove handy when performing certain settings or operations.



This icon indicates a reference to more detailed information.

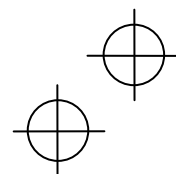
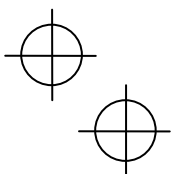

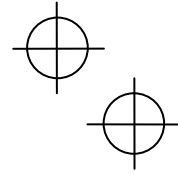
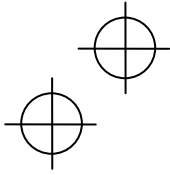

## Table of Contents

Preface .....	i	Chapter 6 SPEED CONTROL .....	6-1
■ Safety precautions.....	i	6.1 Specifications .....	6-1
Chapter 1 BEFORE USING THE INVERTER .....	1-1	6.2 Terminal Functions .....	6-1
1.1 Acceptance Inspection.....	1-1	6.3 Function Code List .....	6-2
1.2 Mounting the EFC Interface Card .....	1-2	6.4 Function Code Details .....	6-2
1.3 EFC Specifications and EFC Mounting		Chapter 7 POSITIONING CONTROL .....	7-1
Instructions.....	1-3	7.1 Specifications .....	7-1
1.3.1 EFC specifications .....	1-3	7.2 Terminal Functions .....	7-1
1.3.2 Mounting the EFC to the motor.....	1-3	7.3 Function Code List .....	7-2
1.3.3 Wiring between the EFC interface		7.4 Description of the Control.....	7-3
card and EFC .....	1-4	7.4.1 Symbols .....	7-4
1.3.4 Setting up the power supply for the		7.4.2 Input/output terminal functions .....	7-5
EFC or pulse train generator .....	1-5	7.5 Function Code Details .....	7-6
1.3.5 Connecting to option terminals .....	1-5	7.6 Monitoring .....	7-6
1.3.6 Option terminals .....	1-6	7.6.1 Monitoring items.....	7-6
Chapter 2 CONNECTION DIAGRAMS .....	2-1	7.6.2 Displaying system on the LED	
2.1 For Frequency Control with Pulse Rate		monitor .....	7-7
Input.....	2-1	7.6.3 Positioning control status .....	7-7
2.2 For Speed and Positioning Controls .....	2-2	7.7 Serial Pulse Receiving Function.....	7-8
Chapter 3 PREPARATION FOR OPERATING.....	3-1	7.8 Assignment of EFC Terminals When Shared	7-9
Chapter 4 EFC INTERFACE CARD FUNCTIONS .....	4-1	Chapter 8 PROTECTIVE FUNCTIONS .....	8-1
4.1 Speed Control .....	4-1	8.1 Overspeed Alarm ( <i>os</i> ).....	8-1
4.2 Frequency Control with Pulse Rate Input .....	4-1	8.2 Excessive Speed Deviation Alarm ( <i>ere</i> ) .....	8-1
4.3 Positioning Control.....	4-1	8.2.1 Function codes.....	8-2
Chapter 5 FREQUENCY CONTROL WITH		8.2.2 Excessive speed deviation	
PULSE RATE INPUT.....	5-1	detection.....	8-2
5.1 Specifications.....	5-1	8.3 Positioning Control Alarm ( <i>ero</i> ) .....	8-3
5.2 Terminal Functions.....	5-1	8.3.1 Function codes.....	8-3
5.3 Function Code List.....	5-1		
5.4 Function Code Details.....	5-2		
5.5 Description of the Control .....	5-3		
5.5.1 Input pulse command polarity .....	5-3		
5.5.2 Block diagram.....	5-3		

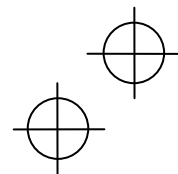
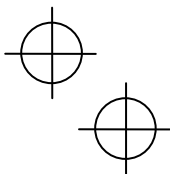

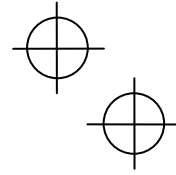
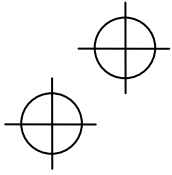

## Chapter 1 BEFORE USING THE INVERTER

### 1.1 Acceptance Inspection

Unpack the package and check the following:

- (1) The EFC interface card is the model you ordered.
- (2) The EFC interface card is not damaged during transportation--no defective parts or lacking parts.
- (3) The model name "VXR-EFC" is printed on the EFC interface card. (See Figure 1.2.)
- (4) The EFC interface card is applicable to your inverter.

Table 1.1 lists the inverter's ROM version to which the EFC interface card is applicable.

Table 1.1 Applicable ROM Version

Series	Type of inverter	Applicable motor rating	ROM version
Jaguar VXR	VXR□□□E1□-□□□	All capacities	0700 or later

#### Checking the ROM version

Use Menu #5 "Maintenance Information" on the keypad. (Refer to the Jaguar VXR Instruction Manual, Chapter 3, Section 3.4.6 "Reading maintenance information.")

Display on LED Monitor	Item	Description
5_14	Inverter's ROM version	Shows the inverter's ROM version as a 4-digit code.

If you suspect the product is not working properly or if you have any questions about your product, contact your Fuji Electric representative.

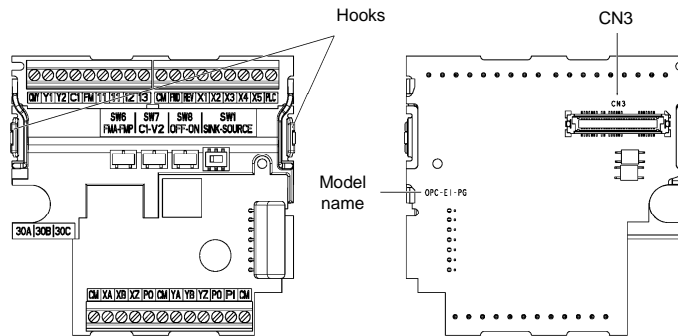

Figure 1.1

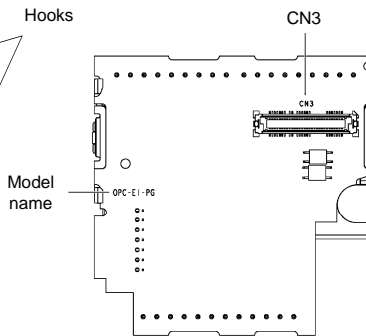
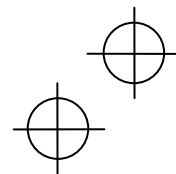
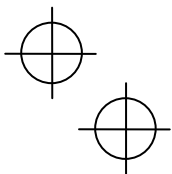

Figure 1.2



## 1.2 Mounting the EFC Interface Card



### **WARNING**

- Turn the power OFF and wait for at least five minutes before starting installation.  
**Otherwise, electric shock could occur.**

### **CAUTION**

- Do not use the product that is damaged or lacking parts.  
**Doing so could cause a failure and injuries.**
- Prevent lint, paper fibers, sawdust, dust, metallic chips, or other foreign materials from getting into the inverter.  
**Otherwise, a fire or an accident might result.**
- Incorrect handling when mounting or removing the product could cause a failure.  
**A failure might result.**

When handling the EFC interface card and interface printed circuit board (interface PCB), take any antistatic measure or hold their hooks taking care not to directly touch their circuit boards; otherwise, the static electricity charged in your body may damage them.

- (1) Remove the terminal cover.  
 For details on how to remove the terminal cover, refer to the Jaguar VXR Instruction Manual, Chapter 2, Section 2.3 "Wiring."
- (2) If the interface PCB is installed on the inverter, push the hooks provided on both ends of the interface PCB and pull it up and out of the inverter with both hands. (Store the removed interface PCB for future use.)
- (3) Connect the CN3 connector (shown in Figure 1.2) on the EFC interface card to the connector on the inverter until it clicks into place.
- (4) For inverters of 0.75 kW or below: Before reinstalling the terminal cover, cut off the barrier (see Figure 1.3) of the terminal cover using nippers or the like
- (5) Reinstall the terminal cover, taking care not to pinch control signal lines.  
 When reinstalling the terminal cover, refer to the Jaguar VXR Instruction Manual, Chapter 2, Section 2.3 "Wiring."

 **Note** For inverters of 3.7 kW or below: When performing the wiring for the main circuit terminals, you need to remove the EFC interface card beforehand.

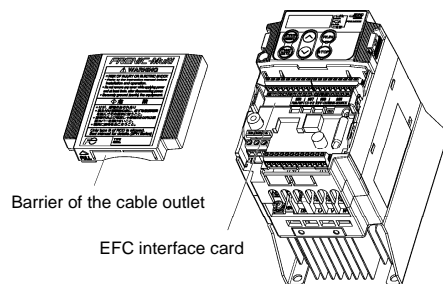
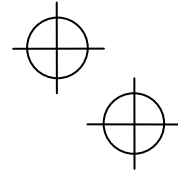
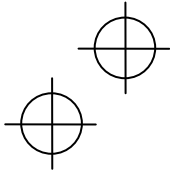

Figure 1.3



### 1.3 EFC Specifications and EFC Mounting Instructions

<b>CAUTION</b>	
<ul style="list-style-type: none"> <li>Using the EFC whose specifications are not satisfied may cause the inverter and equipment to malfunction. <b>Doing so could cause failure or injuries.</b></li> </ul>	

#### 1.3.1 EFC specifications

Table 1.2 lists the applicable EFC specifications.

Table 1.2 Specifications of Applicable EFC and EFC Interface Card

Item		Specifications
Applicable EFC	Encoder system	Incremental system
	Pulse resolution	20 to 3000 P/R
	Input power requirements	5 VDC $\pm$ 10% / 100 mA (200 mA, when a single EFC is mounted.)
EFC power supply	Internal power supply	+5 VDC $\pm$ 10% / 200 mA
	External power supply	+5 VDC $\pm$ 10%, 200 mA or more
Output signal	Open collector (pull-up resistor: 620 $\Omega$ ) Complementary (totem-pole push-pull) voltage output	

Note 1: The wiring length between the EFC and inverter should not exceed 20 m.  
 Note 2: When the EFC power is 200 mA or more, use an external power supply.  
 Note 3: The external power supply should satisfy the voltage specifications of the EFC.

#### 1.3.2 Mounting the EFC to the motor

The counterclockwise rotation when viewed from the motor output shaft is regarded as "forward rotation" (see Figure 1.4). During rotation in the forward direction, the EFC output pulse forms the forward signal as shown in Figure 1.5 (B phase advances 90 degrees from A phase). During rotation in the reverse direction, the EFC output pulse forms reverse signal (A phase advances 90 degrees from B phase).

Mount the EFC to the motor with a coupling, etc.

Table 1.3 lists the correct configurations of commands, rotational directions, and motor wiring. Any other configuration fails to perform speed control normally.

Table 1.3 Rotational Direction of Encoder and Motor Shafts

Run command	Rotational direction		Motor wiring
	Encoder shaft	Motor shaft	
FWD	Forward	Forward	U V W phases in order
REV	Reverse	Reverse	U V W phases in order
FWD	Forward	Reverse	U V W phases in reverse order
REV	Reverse	Forward	U V W phases in reverse order

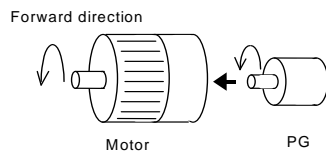

Figure 1.4 Forward Direction of Motor and EFC

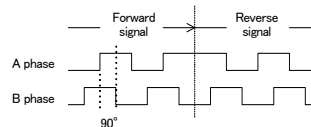
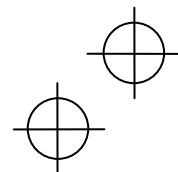
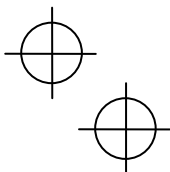
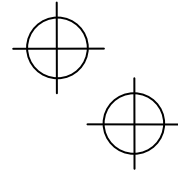
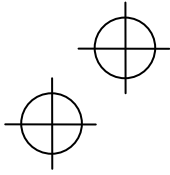

Figure 1.5 Rotational Direction and Output Signal of EFC





You can monitor the digital input status of the EFC interface card with the inverter keypad. For details, refer to the Jaguar VXR Instruction Manual, Chapter 3, Section 3.4.5 "Checking I/O signal status."

### 1.3.3 Wiring between the EFC interface card and EFC

<b>⚠ WARNING</b>
<ul style="list-style-type: none"><li>• Turn the inverter's power OFF and wait for at least five minutes before starting connection.</li><li>• Qualified electricians should carry out wiring. <b>Otherwise, electric shock could occur.</b></li></ul>

<b>⚠ CAUTION</b>
<ul style="list-style-type: none"><li>• Noise may be emitted from the inverter, motor and wires. Implement appropriate measure to prevent the nearby sensors and devices from malfunctioning due to such noise. <b>Otherwise, an accident could occur.</b></li></ul>

Wire the EFC to the EFC interface card, observing the following precautions and referring to the connection diagrams given in Figures 2.1 to 2.3.

- (1) Turn the inverter's power OFF.
- (2) Use a shielded wire for wiring between the EFC and the EFC interface card.
- (3) To prevent malfunction due to noise, keep the wiring away from the main circuit wiring of the inverter and the power wiring of other devices as far as possible (at least 10 cm). Do not route them in the same duct.
- (4) Complete the wiring for the EFC before turning the inverter's power ON.
- (5) The wire size applicable to the option connection terminal on the inverter is AWG 18-24.

When using a wire with its end being stripped, strip its end by 5 to 7 mm. When using a ferrule, use a vinyl-insulated ferrule.

Loosen the fixing screw, insert the wire end into the opening of the terminal block, and tighten the screw.



Figure 1.6 Stripping the Wire End Before Connection to Terminal Board

Recommended wire: AWG 18-24 for rated temperature 105°C (UL)

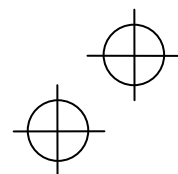
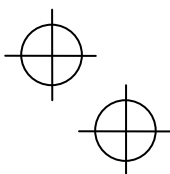

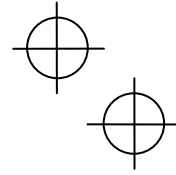
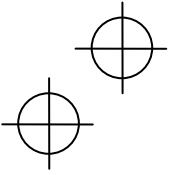

### 1.3.4 Setting up the power supply for the EFC or pulse train generator

<b>⚠ CAUTION</b>
The external power supply should match the EFC power voltage or pulse train generator voltage. <b>Otherwise, a failure might result.</b>

#### When using an internal power supply

Connect the power supply wire to the terminal [PO] on the EFC interface card.

#### When using an external power supply

Connect the power supply wire to the terminal [PI] on the EFC interface card.

### 1.3.5 Connecting to option terminals

Table 1.4 lists terminal symbols, names and functions of the option terminals on the EFC interface card.

Table 1.4 Option Terminals and Their Specifications

Classification	Terminal symbol	Name	Functions
EFC/Pulse input	PI	External power supply input	Power input terminal from the external device External power supply capacity: 5 VDC $\pm$ 10%, 200 mA or more
	PO	Power supply for EFC	Power output terminal 5 VDC $\pm$ 10%, Maximum output 200 mA
	CM	EFC common	Common terminal for power supply and EFC input
	XA	A phase pulse input X	Pulse input terminal for commands To supply speed commands from the pulse train generator or EFC, connect an open-collector output signal or complementary output signal to these terminals.
	XB	B phase pulse input X	
	XZ	Z phase pulse input X	
	YA	A phase pulse input Y	Pulse input terminal for feedback These terminals are for the detection of the inverter-driven motor speed. Connect an open-collector output signal or complementary output signal to these terminals
	YB	B phase pulse input Y	
	YZ	Z phase pulse input Y	

**Note:** Incorrect wiring of A/B phase could fail to run the motor normally or cause an inverter trip.

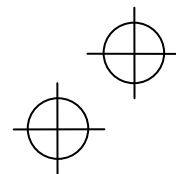
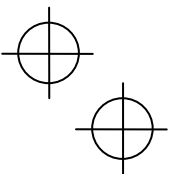

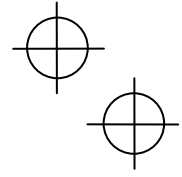
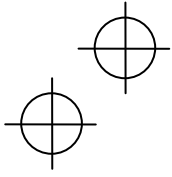

### 1.3.6 Option terminals

CM	XA	XB	XZ	PO	CM	YA	YB	YZ	PO	PI	CM
----	----	----	----	----	----	----	----	----	----	----	----

Screw size: M2  
Tightening torque: 0.22 to 0.25 N·m

Figure 1.8 Option Terminals



Terminal [PLC] on the EFC interface card cannot supply power to external equipment. Use the terminal only for receiving power from external equipment.

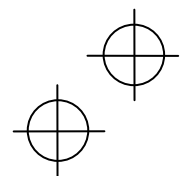
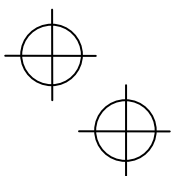

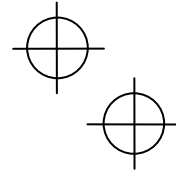
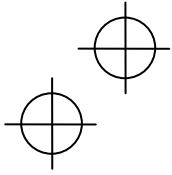

## Chapter 2 CONNECTION DIAGRAMS

### 2.1 For Frequency Control with Pulse Rate Input

■ Figure 2.1 shows connection diagram examples for frequency control with pulse rate input.

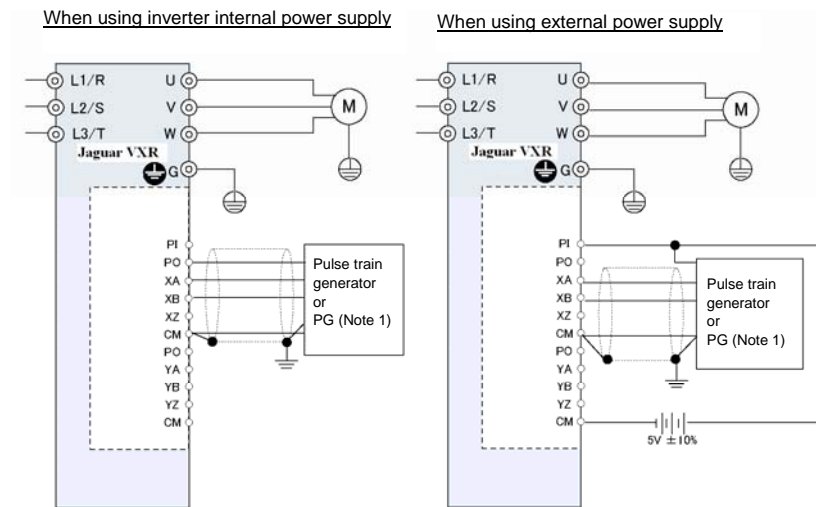

(Note 1) For details about applicable PG specifications, refer to Table 1.2 in Chapter 1, Section 1.3.1 "PG specifications."

Figure 2.1 Connection Diagrams for Frequency Control with Pulse Rate Input

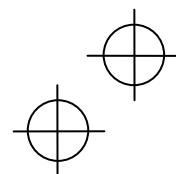
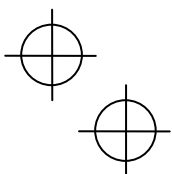

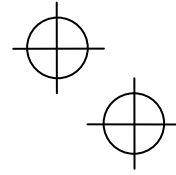
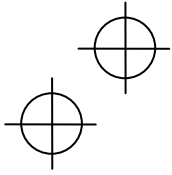

## 2.2 For Speed and Positioning Controls

- Figure 2.2 shows connection diagram examples for speed and positioning controls.

When using inverter internal power supply

When using external power supply

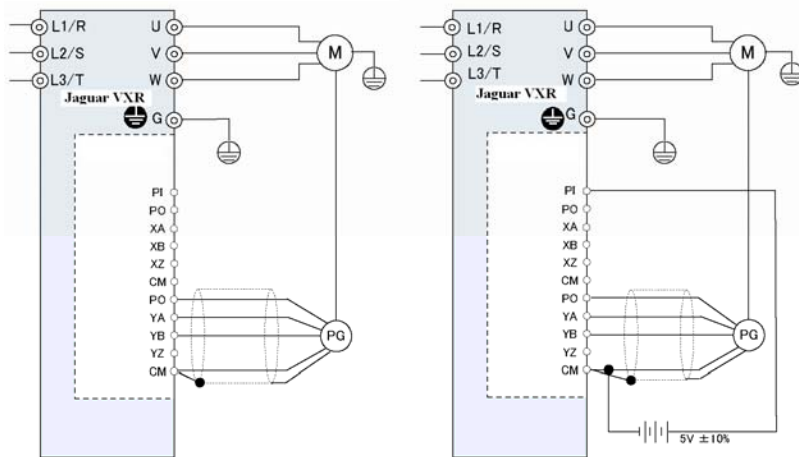
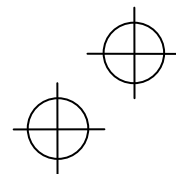
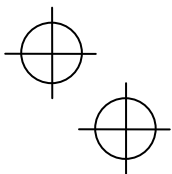
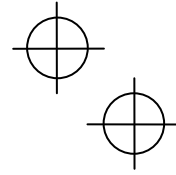
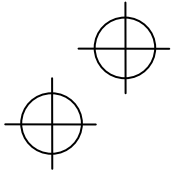

Figure 2.2 Connection Diagrams for Speed Control with PG and Positioning Control





- In order to conform the inverter to the requirements of the Electromagnetic Compatibility (EMC) Directive, connect the shielded cable to the ground of the inverter as shown below.

When using inverter internal power supply

When using external power supply

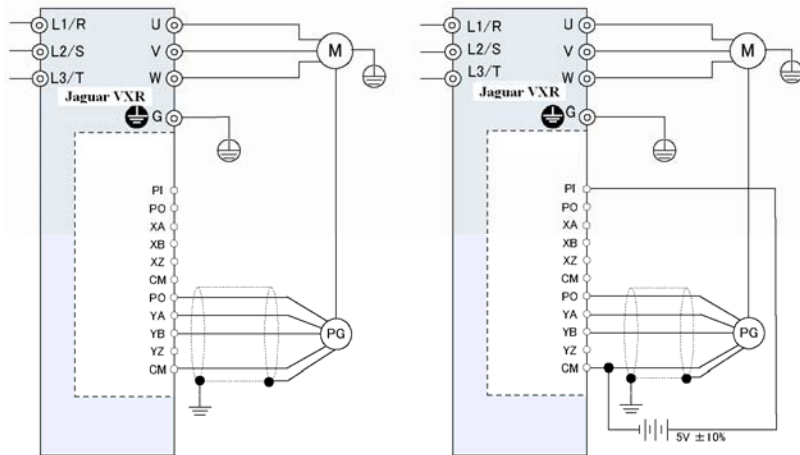
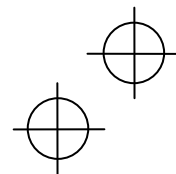
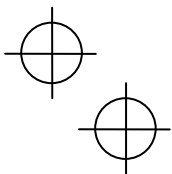
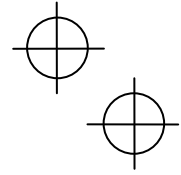
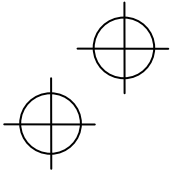

Figure 2.3 Connection Diagrams for Compliance with EMC Directive





### Chapter 3 PREPARATION FOR OPERATING

After completion of mounting/wiring but before turning the inverter's power ON, check the followings.

- (1) The wiring is correct.
- (2) There is no cable waste or screws left.
- (3) The screws and terminals are firmly tightened.
- (4) The stragglng wires at ferrules are not short-circuited to other terminals.

Furthermore, after powering the inverter ON but before starting inverter operation, check the followings.

 <b>CAUTION</b>
<ul style="list-style-type: none"><li>• Check the wiring surely before running the inverter. Incorrect wiring causes the inverter or other devices to malfunction. <b>Failure to do so could cause failure or injuries.</b></li></ul>

 <b>WARNING</b>
<ul style="list-style-type: none"><li>• Be sure to mount the terminal cover before turning the power ON. Do not remove any cover while the power is ON. <b>Doing so could cause electric shock.</b></li><li>• Confirm and adjust the setting of the function codes before running the inverter. <b>Otherwise, an accident could occur.</b></li></ul>

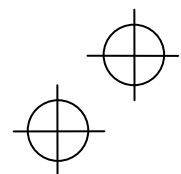
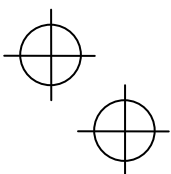

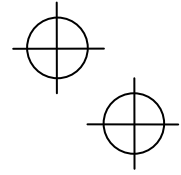
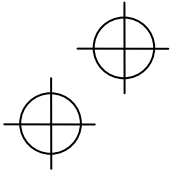

## **Chapter 4 EFC INTERFACE CARD FUNCTIONS**

The combination of the EFC interface card and the EFC (open collector or complementary output) makes feedback signals available, enabling the following controls.

### **4.1 Speed Control**

This refers to speed control with EFC. (For details, refer to Chapter 6.)

### **4.2 Frequency Control with Pulse Rate Input**

This control specifies a frequency command with pulse trains. (For details, refer to Chapter 5.) It can be used together with speed control with EFC at the same time.

### **4.3 Positioning Control**

This refers to simplified positioning control that detects the pulse count with feedback signals sent from the EFC. (For details, refer to Chapter 7.)

This control can be used together with speed control with EFC and frequency control with pulse rate input at the same time.

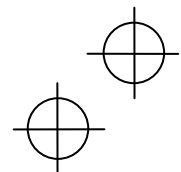
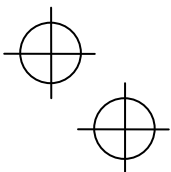

## Chapter 5 FREQUENCY CONTROL WITH PULSE RATE INPUT

The pulse rate input feature supplies a frequency command to the inverter in pulse trains. Two pulse input modes are available--B phase pulse (with signs) and forward/reverse rotation pulse trains.

The frequency control with pulse rate input can be enabled concurrently with the speed and positioning controls with EFC.

### 5.1 Specifications

Table 5.1 lists the specifications of frequency control with pulse rate input.

Table 5.1 Specifications for Pulse Train Inputs

Item	Specifications
Reference frequency range	0 to 400 Hz
Frequency accuracy	±0.2% of maximum frequency
Output circuits	Open collector Complementary
Input pulse level	5 VDC ±10%
Maximum cable length and maximum input pulse rate	20 m, 30 kp/s

### 5.2 Terminal Functions

Table 5.2 lists terminal specifications.

Table 5.2 Terminal Specifications

Terminal symbol	Name	Descriptions
PI	Power input terminal	Receives power for the EFC from an external source.
PO	Power output terminal	Outputs power to the EFC.
CM	Common terminal	Common terminal for the EFC power.
XA	Command input terminal for A phase pulse train	Receives an A phase feedback pulse train.
XB	Command input terminal for B phase pulse train	Receives a B phase feedback pulse train.
XZ	--	Reserved.



The pulse count of [XA] and [XB] terminal inputs can be displayed on the keypad by using Menu #4 "I/O Checking," Check item 4\_15. For details, refer to the inverter's instruction manual. (See the description of function code E52.)

### 5.3 Function Code List

Table 5.3 lists function codes to be used for pulse rate input. Mounting the EFC interface card can display o codes.

Table 5.3 Related Function Codes

Code	Name	Data setting range	Unit	Default setting	Change when running
F01 (C30)	Frequency Command 1 (Frequency Command 2)	0 to 3, 5, 7, 11, 12	-	0 (2)	N
o01	Command/Feedback Input (Input mode)	0, 1, 2, 10, 11, 12, 20, 21, 22	-	0	N
o06	Command: (Pulse train input) (Filter time constant)	0.000 to 5.000	s	0.005	Y
o07	(Pulse count factor 1)	1 to 9999	-	1	N
o08	(Pulse count factor 2)	1 to 9999	-	1	N

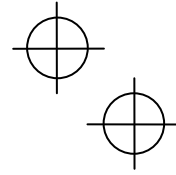
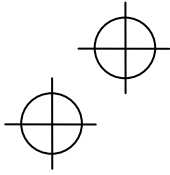

#### 5.4 Function Code Details

**F01**      Frequency Command 1      (C30: Frequency Command 2)  
 To drive the inverter with the pulse input frequency command, set the F01 (C30) data to "12" for frequency command 1 (frequency command 2).

**o01**      Command/Feedback Input (Input mode)  
 This function code switches the pulse input mode with the data in the ones place as listed in Table 5.4.

Table 5.4 Data for o01

Pulse input mode	Data for o01	Remarks
B phase pulse input	□0	
Pulse input with polarity	□1	
A/B phase pulse input	□2	Not available (This setting produces 0 p/s.)

**o06**      Command (Pulse train input) (Filter time constant)  
 This function code specifies a time constant determining a linear delay of the low pass filter for the reference speed given by pulse train. Adjusting this time constant can stabilize the speed command in low pulse rate.

**o07**      Command (Pulse train input) (Pulse count factor 1)  
**o08**      Command (Pulse train input) (Pulse count factor 2)  
 For the pulse input command, these function codes define the relationship between the input pulse rate and reference frequency.

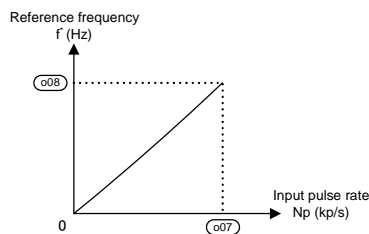
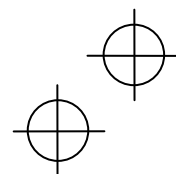
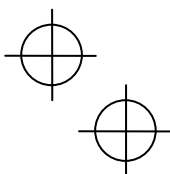

Figure 5.1 Relationship between the Input Pulse Rate and Reference Frequency

As shown in Figure 5.1, set the input pulse rate (kp/s) to the o07 data and set the reference frequency (Hz) at the pulse rate (specified by o07) to the o08 data. The relationship between the input pulse rate at A or B phase input and the reference frequency  $f^*$  (or reference speed) can be calculated by the following expression.

$$f^* \text{ (Hz)} = N_p \text{ (kp/s)} \times \frac{\text{Pulse count factor 2 (o08)}}{\text{Pulse count factor 1 (o07)}}$$

- $f^*$  (Hz) : Reference frequency (In speed control, the frequency corresponding to the speed)
- $N_p$  (kp/s) : Input pulse rate at A or B phase input



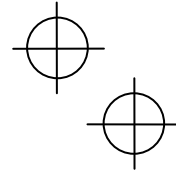
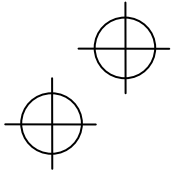

## 5.5 Description of the Control

### 5.5.1 Input pulse command polarity

In the B phase pulse input system shown in Figure 5.2, the A phase voltage determines the polarity of commands. In the run forward/reverse pulse input system shown in Figure 5.3, the presence of A or B phase input determines the polarity of commands.

The combination of the command pulse input and **FWD/REV** command determines the actual motor rotational direction. Table 5.5 lists the relationship between the polarity of the pulse input, **FWD/REV** command and motor rotational direction.

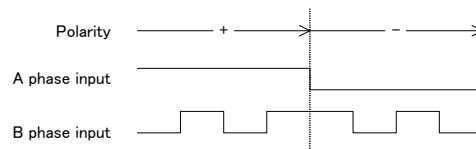

Figure 5.2 Polarity of the B Phase Pulse Input

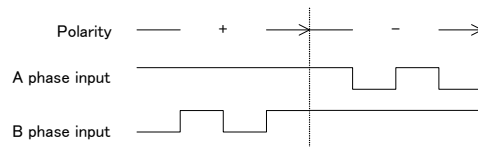

Figure 5.3 Polarity of the Run Forward/Reverse Pulse Input

Table 5.5 Relationship between Polarity of the Pulse Input, **FWD/REV** Command and Motor Rotational Direction

Command polarity determined by pulse input	Run command	Motor rotational direction
+	<b>FWD</b>	Forward
+	<b>REV</b>	Reverse
-	<b>FWD</b>	Reverse
-	<b>REV</b>	Forward

### 5.5.2 Block diagram

Figure 5.4 shows a block diagram of the pulse train input command system.

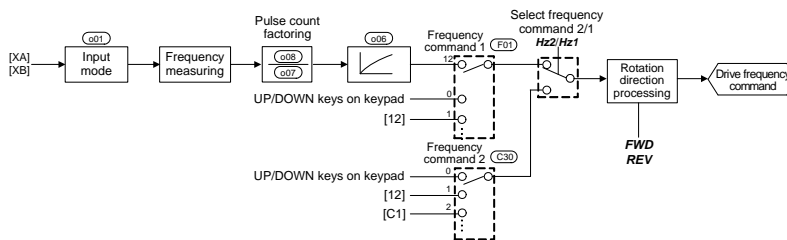
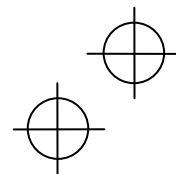
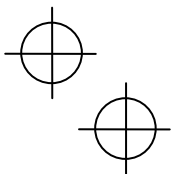
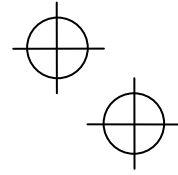
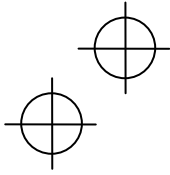

Figure 5.4 Block Diagram of the Pulse Train Input System





## Chapter 6 SPEED CONTROL

Using a EFC feedback signal enables V/f control with EFC and dynamic vector control with EFC. It speed-controls the detection speed of the motor via the EFC and compensates the frequency with PI control so that the motor speed follows the speed command.

The speed control with EFC can be enabled concurrently with the frequency control with pulse rate input and positioning control.

### 6.1 Specifications

Table 6.1 lists the specifications of speed control with EFC.

Table 6.1 Specifications of Speed Control with EFC

	Item	Specifications	Remarks
Control	Speed control range	180 to 3600 r/min	When running at constant speed (The maximum speed refers to the speed corresponding to the maximum frequency.)
	Speed control accuracy	±0.2% of maximum speed	
Electrical specifications	Input pulse rate	75 p/s to 30 kp/s	Maximum wiring length: 20 m when using A/B phase pulse input

### 6.2 Terminal Functions

Table 6.2 lists terminal functions.

Table 6.2 Terminal Functions

Location	Terminal symbol	Name	Functions
EFC interface card	PI	Power input terminal	Receives power for the EFC from an external source.
	PO	Power output terminal	Outputs power to the EFC.
	CM	Common terminal	Common terminal for the EFC power.
	YA	Feedback input terminal for A phase pulse train	Receives an A phase feedback pulse train.
	YB	Feedback input terminal for B phase pulse train	Receives a B phase feedback pulse train.
	YZ	--	Reserved.
Inverter	Terminal [X] (Note)	"Switch speed control" terminal	Temporarily cancels speed control with EFC.



The pulse count of [YA] and [YB] terminal inputs can be displayed on the keypad by using Menu #4 "I/O Checking." Check item 4\_17. For details, refer to the inverter's instruction manual. (See the description of function code E52.)

(Note) "Switch speed control" terminal

Setting "27" to any of function codes E01 to E05, E98 and E99 assigns the "Switch speed control" command **EFC/Hz** to the corresponding one of digital input terminals [X1] to [X5], [FWD] and [REV]. This setting enables the assigned terminal to be used for cancelling the speed control with EFC. While the inverter is running, turning this terminal on or off will be ignored. After the inverter stops, it will be validated. If no **EFC/Hz** is assigned, speed control with EFC is always enabled.

Table 6.3 Function of **EFC/Hz** Terminal Command

Terminal command <b>EFC/Hz</b>	Function
ON	Enable speed control with EFC
OFF	Disable speed control with EFC

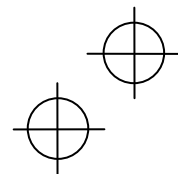
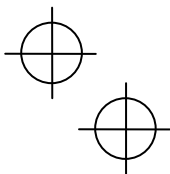

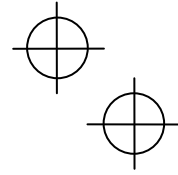
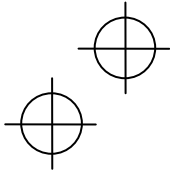

### 6.3 Function Code List

Table 6.4 lists function codes to be used for speed control with EFC. Mounting the EFC interface card can display o codes.

Table 6.4 Related Function Codes

Code	Name	Data setting range	Unit	Default setting	Change when running	
F42 (A14)	Control Mode Selection 1 (Control Mode Selection 2)	0 to 4	-	0	N	
o01	Command/ Feedback Input (Input mode)	0, 1, 2, 10,11,12, 20,21,22	-	0	N	
o02	Speed Control	(P Gain)	0.01 to 200.00	Times	10.00	Y
o03		(Integral time)	0.000 to 5.000	s	0.100	Y
o04		(Filter time constant)	0.000 to 5.000	s	0.020	Y
o09	Feedback Input	(Encoder pulse resolution)	20 to 3600	P/R	1024	N
o10		(Filter time constant)	0.000 to 5.000	s	0.005	Y
o11		(Pulse count factor 1)	1 to 9999	-	1	N
o12		(Pulse count factor 2)	1 to 9999	-	1	N
o13	Speed Control	(Output limiter)	0.00 to 100.00	%	100.00	Y

### 6.4 Function Code Details

**F42** Control Mode Selection 1 (A14: Control Mode Selection 2)

To select the V/f control with EFC interface or dynamic torque vector control with EFC interface, set the F42 (A14) data to "3" or "4," respectively.

**o01** Command/Feedback Input (Input mode)

This function code switches the feedback pulse input mode with the data in the tens place as listed below.

Table 6.5 Data for o01

Feedback pulse input mode	Data for o01
B phase pulse input	0□
Forward/reverse pulse input	1□
A/B phase pulse input	2□

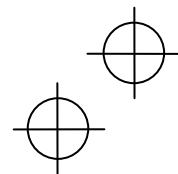
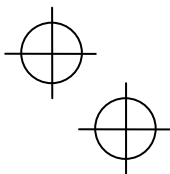

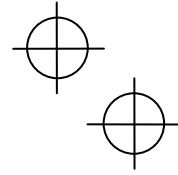
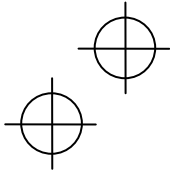

---

o02	Speed Control (P Gain)
o03	Speed Control (Integral time)

---

These function codes specify the PI constants of a speed controller. The expression below shows the transfer function of the controller.

$$f_s = k_p \left(1 + \frac{1}{sT_I}\right) \times \varepsilon$$

$K_p$ : P gain (o02)  
 $T_I$ : Integral time (o03)  
 $f_s$ : Slip frequency  
 $\varepsilon$ : Speed deviation  
 $s$ : Laplace operator

Suppose that the P gain is 1.0 when the speed deviation  $\varepsilon = 100\%$  (Maximum Frequency F03 (A01)) and  $f_s$  is 1% of the maximum frequency.

Suppose that the I integral time = 1.000 seconds when the o03 data is 1.000.

Setting an excessive P gain may cause system hunting. A roughly recommended P gain should not exceed 35.00 in the ordinary system.

Modifying F03 (A01) data requires readjustment of o02 and o03 data.

---

o04	Speed Control (Filter time constant)
-----	--------------------------------------

---

This function code specifies a time constant determining a linear delay of the low pass filter for the speed command given by pulse train. Use this function code to suppress an overshoot that occurs, for example, when the speed command varies.

---

o09	Feedback Input (Encoder pulse resolution)
-----	-------------------------------------------

---

This function code specifies the resolution of the encoder mounted on the inverter-driven motor.

---

o10	Feedback Input (Filter time constant)
-----	---------------------------------------

---

This function code specifies a time constant determining a linear delay of the low pass filter for the speed feedback given by pulse train. Use this function when large ripple components superpose the feedback pulse train.

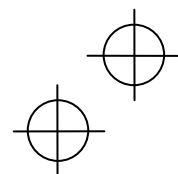
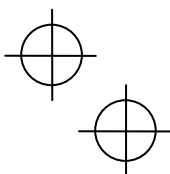

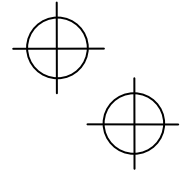
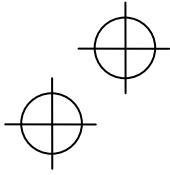

---

o11	Feedback Input (Pulse count factor 1)
o12	Feedback Input (Pulse count factor 2)

---

These function codes specify pulse count factors 1 and 2.

Use these function codes when the motor shaft speed differs from the encoder (EFC) shaft speed depending upon a transmission reduction ratio.

Refer to Figure 6.1 and the expressions below for calculation of the count factors.

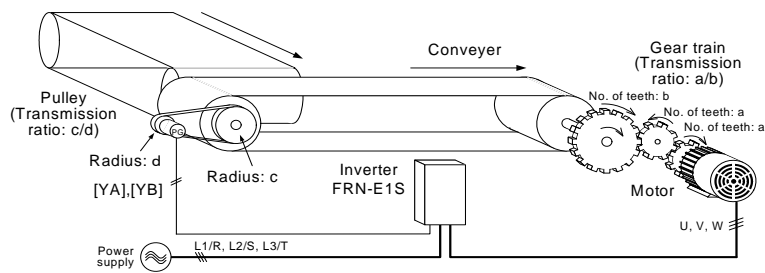

Figure 6.1 Speed Control Model Using a EFC

$$\text{Motor shaft speed} = \frac{\text{Pulse count factor 2 (o12)}}{\text{Pulse count factor 1 (o11)}} \times \text{Encoder shaft speed}$$

$$\frac{\text{Pulse count factor 2 (o12)}}{\text{Pulse count factor 1 (o11)}} = \frac{b}{a} \times \frac{d}{c}$$

---

o13	Speed Control (Output limiter)
-----	--------------------------------

---

This function code specifies the output limit percentage for the speed controller (PI controller). Specification of 100.00% is equivalent to the maximum speed (maximum frequency).

To suppress the frequency control amount (PI controller output) to the extent of the motor's slip frequency in the speed control mode, use this function.

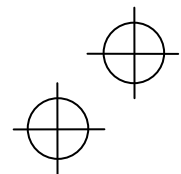
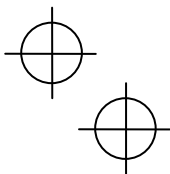

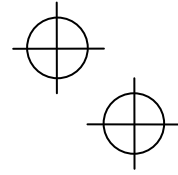
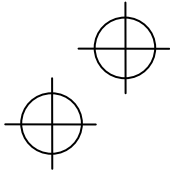

## Chapter 7 POSITIONING CONTROL

Using EFC feedback signals enables positioning control. The inverter internally counts the feedback pulses and controls the motor so that the control object moves from the previously specified start point, decelerates and switches to the creep speed operation to arrive at the specified stop position. The positioning control can be enabled concurrently with the frequency control with pulse rate input and speed control with EFC.

### 7.1 Specifications

Table 7.1 lists the specifications of positioning control.

Table 7.1 Specifications of Positioning Control

	Item	Specifications	Remarks
Speed control	Range	180 to 3600 r/min	
Pulse input	Maximum pulse rate	30 kp/s	Wiring length: Max. 20 m

### 7.2 Terminal Functions

Table 7.2 lists terminal functions for the positioning control alone (no concurrent use of the speed control with EFC or frequency control with pulse rate input).

Table 7.2 Terminal Functions

(no concurrent use of speed control with EFC or frequency control with pulse rate input)

Terminal symbol	Name	Functions	Remarks
PI	Power input terminal	Receives power for the EFC from an external source.	
PO	Power output terminal	Outputs power to the EFC.	
CM	Common terminal	Common terminal for the EFC power.	
XA	Command input terminal for A phase pulse train	Receives an A phase command pulse train.	Specify the input mode with J86.
XB	Command input terminal for B phase pulse train	Receives a B phase command pulse train.	
XZ	--	Reserved.	
YA	Feedback input terminal for A phase pulse train	Receives an A phase feedback pulse train.	Specify the input mode with o01.
YB	Feedback input terminal for B phase pulse train	Receives a B phase feedback pulse train.	
YZ	Feedback input terminal for Z phase pulse train	Receives a Z phase feedback pulse train.	No connection needed if no preset positions are specified with J76 and J77.



- The pulse count of [XA], [XB], [YA], [YB] and [YZ] inputs can be displayed on the keypad by using Menu #4, "I/O Checking," Check items 4\_15, 4\_17, and 4\_18. For details, refer to the inverter's instruction manual. (See the description of function code E52.)
- When the positioning control is enabled concurrently with the speed control with EFC or frequency control with pulse rate input, the specifications of terminals [XA], [XB], [XZ], [YA], [YB], and [YZ] differ from the ones listed above. For details, refer to Section 7.8 "Assignment of EFC Terminals When Shared." (Refer to the description of function code o01.)

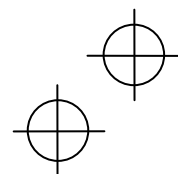
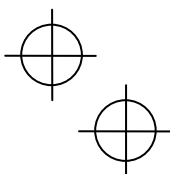

### 7.3 Function Code List

Table 7.3 lists function codes to be used for positioning control. Mounting the EFC interface card can display o codes.

Table 7.3 Function Codes

Code	Name	Data setting range	Unit	Default setting	Change when running
E01 to E05, E98, E99	Terminal [Xn] Function	42 (1042): Activate the limit switch at start point, <b>LS</b> 43 (1043): Start/reset, <b>S/R</b> 44 (1044): Switch to the serial pulse receiving mode, <b>SPRM</b> 45 (1045): Enter the return mode, <b>RTN</b>	-	-	N
E20, E21, E27	Terminal [Y1] Function Terminal [Y2] Function Terminal [30A/B/C] Function	80 (1080): Stop position override alarm, <b>OT</b> 81 (1081): Timer output, <b>TO</b> 82 (1082): Positioning completed, <b>PSET</b> 83 (1083): Current position count overflowed, <b>POF</b>	-	-	N
J73	Positioning Control (Start timer)	0.0: Disable 0.1 to 1000.0: Preset time	s	0.0	Y
J74	(Start point, upper digits)	-999 to 999	p	0	Y
J75	(Start point, lower digits)	[P], 0 to 9999 *1	p	0	Y
J76	(Preset point, upper digits)	-999 to 999	p	0	Y
J77	(Preset point, lower digits)	[P], 0 to 9999 *1	p	0	Y
J78	(Creep speed switch point, upper digits)	0 to 999	p	0	Y
J79	(Creep speed switch point, lower digits)	0 to 9999	p	0	Y
J80	(Creep speed)	0 to 400	Hz	0	Y
J81	(End point, upper digits)	-999 to 999	p	0	Y
J82	(End point, lower digits)	0 to 9999	p	0	Y
J83	(Positioning allowance)	0 to 9999	p	0	Y
J84	(End timer)	0.0: Disable. 0.1 to 1000.0: Preset time	s	0.0	Y
J85	(Coasting compensation)	0 to 9999	p	0	Y
J86	(End point command)	0: B phase pulse input 1: Pulse input with polarity	-	0	Y
J87	(Preset positioning requirement)	0: Forward rotation direction 1: Reverse rotation direction 2: Both forward/reverse rotation direction	-	0	N
J88	*2 (Position detection direction)	0: Forward direction 1: Invert the current direction ( $\times -1$ ).	-	0	N
o01	Command/Feedback Input (Input mode)	0, 1, 2, 10,11,12, 20,21,22	-	0	N

\*1 [P]: Current position (Absolute position)  
Switching between "0" and [P] requires the simultaneous keying:  $\text{STOP} + \checkmark$  keys from "0" to [P] and  $\text{STOP} + \checkmark$  keys from [P] to "0."

\*2 Even if wrong wiring of the EFC inverts the position detection direction, using J88 can correct the direction without rewiring.

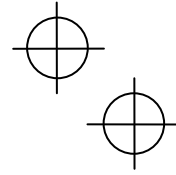
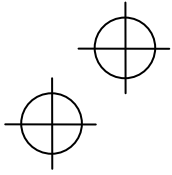

#### 7.4 Description of the Control

The EFC interface card allows the inverter to internally count feedback pulses issued from the encoder (EFC) and control the motor so that the control object starts moving from the previously specified start point (S point), decelerates and switches to the creep speed operation to arrive at the specified stop position (E point).

Turning a run command ON with "Start/reset" command **S/R** being ON starts the positioning control. See Figure 7.1 "Positioning Control Model" and Table 7.4.

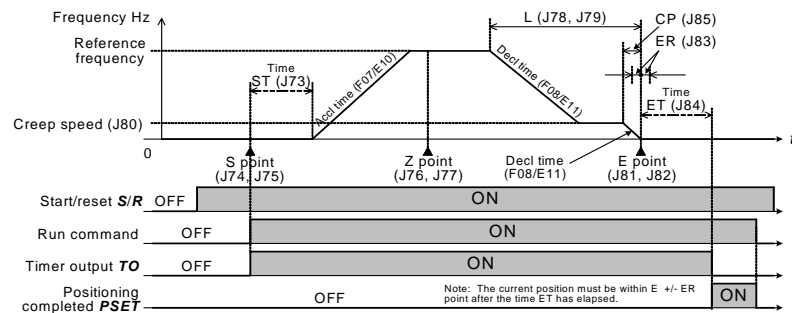

Figure 7.1 Positioning Control Model



- The positioning control applies to motor 1 only.
- During jogging (inching) operation or when the PID control is enabled ( $J01 \neq 0$ ), the positioning control is disabled.
- An undervoltage alarm that occurs in positioning control triggers an alarm *ero*; however, the inverter does not enter the restart mode (specified by F14).
- Enabling the positioning control disables the auto-reset function specified by H04 and H05.



The operation status in positioning control can be displayed on the keypad by using Menu #3 "Drive Monitoring." For details, refer to Section 7.6 "Monitoring." (See the description of function code E52.)

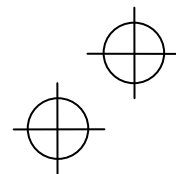
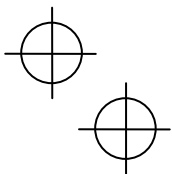

### 7.4.1 Symbols

Table 7.4 lists the meanings of symbols used in Figure 7.1.

Table 7.4 Symbol Details

Symbol	Name	Function code	Descriptions
S point	Start point	J74, J75	<p>This specifies the start position data for the positioning control. It can be the current position [P] (absolute position) or numerical value (relative position). Specification of an absolute position and that of a relative position produce different results as described below.</p> <p><b>[Absolute position]</b>            Specifying [P] regards the current position as a start point. When starting the positioning control, the inverter applies the current position pulse count as start point data.            (Example) Suppose that the current position pulse count = 10,000, the start point data = [P], and the stop point (E point) pulse count = 20,000. Then, when starting the positioning control, the inverter moves the control object from the current position (10,000, as start point data) to the E point (20,000). Accordingly, the object moving pulse count is 10,000 (20,000 - 10,000).</p> <p><b>[Relative position]</b>            Specifying "a" (numerical value) substitutes "a" for the current position data. When starting the positioning control, the inverter applies "a" pulses as start point data.            (Example) Suppose that the current position pulse count = 10,000, start point data "a" = 4,000, and the stop position (E point) pulse count = 20,000. Then, when starting the positioning control, the inverter moves the control object from the start point pulse count "a" (4,000) instead of the current position data (10,000) to the E point (20,000). Accordingly, the object moving pulse count is 16,000 (20,000 - 4,000).</p>
ST	Start timer	J73	<p>This specifies the waiting time from when a run command comes ON with the <b>S/R</b> terminal command being ON until the inverter starts running the motor. (This covers the delay of brake OFF.)</p> <p>If the output frequency has not been zero (inverter running), turning the terminal command <b>S/R</b> ON does not start the timer count. (During deceleration triggered by turning the run command OFF, the start timer does not start as well.)</p>
Z point	Preset position	J76, J77	<p>When the inverter detects that the Z signal is turned from Low to High first after the <b>LS</b> terminal command is turned from OFF to ON, it corrects the current position data for the preset position data (Z point). This is functionally equivalent to a mechanical position correction or origin point reset.</p> <p>Specifying [P] to the preset position does not perform the Z point correction.</p> <p>It is also possible to restrict the application of the Z point correction with the <b>LS</b> to the motor rotational direction specified by function code J87.</p>
L	Creep speed switch point	J78, J79	<p>This specifies an absolute position pulse count required from a deceleration start point (towards the creep speed specified by J80) to the E point.</p>
CP	Coasting correction	J85	<p>This specifies the deceleration start point that follows the end of creep-speed operation. Specify it with the pulse count from the E point. Take into account the inertia produced when the control object decelerates to stop.</p>
E point	End point	J81, J82	<p>This specifies a target stop position.</p>
ER	Positioning allowance	J83	<p>This specifies the positioning allowance at the E point, that is, "Actual stop position - E point position."</p> <p>After the end timer counts up:            If "Actual stop point - E point" ≤ ER, the inverter issues the "Positioning completed" signal <b>PSET</b>.            If "Actual stop point - E point" &gt; ER, the inverter issues the "Stop point alarm" signal <b>OT</b>.</p>

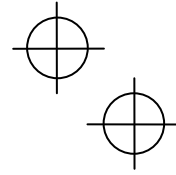
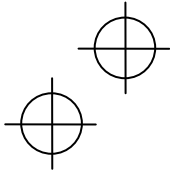

Table 7.4 Symbol Details (Continued)

Symbol	Name	Function code	Descriptions
ET	End timer	J84	<p>This specifies the waiting time from when the control object stops at E point until the inverter can receive the next positioning control signal.</p> <p>After completion of positioning, when this waiting time has elapsed or when 0.5 second has elapsed if ET &lt; 0.5 second, the inverter issues the "Positioning completed" signal <b>PSET</b> or "Stop point alarm" signal <b>OT</b>.</p> <p>Turning the run command OFF when the ET is counting interrupts the counting, so the inverter does not issue <b>PSET</b> or <b>OT</b>.</p> <p>The inverter ensures that <b>PSET</b> and <b>OT</b> signals are kept ON for at least 100 ms.</p>

#### 7.4.2 Input/output terminal functions

Table 7.5 Input Terminal Functions

Terminal function	Terminal command	Description
Activate the limit switch at start point	<b>LS</b>	<p>This is used when the inverter corrects the current position data for the preset position data (Z point) specified by function codes J76 and J77.</p> <p>When the inverter detects that the Z signal is turned from Low to High first after the <b>LS</b> terminal command is turned from OFF to ON, it triggers the Z point correction.</p> <p>In any other conditions, the <b>LS</b> terminal command produces nothing.</p>
Start/reset	<b>S/R</b>	<p>This enables or disables the positioning control.</p> <p>ON: Enable OFF: Disable</p>
Switch to the serial pulse receiving mode	<b>SPRM</b>	<p>This enables or disables the serial pulse receiving mode.</p> <p>When the serial pulse input shares an input terminal with other functional pulse inputs (when the positioning control is concurrently enabled with frequency control with pulse rate input and/or speed control with EFC) with function code setting, the inverter counts input pulses only from the EFC for the stop position when the <b>SPRM</b> terminal command is ON.</p> <p>ON: Enable OFF: Disable</p> <p>If the serial pulse receiving is exclusively assigned to the digital input terminal for the EFC input, however, the inverter counts the input pulses for the stop position, regardless of the <b>SPRM</b> status.</p> <p>Turning the <b>SPRM</b> ON zero-clears the pulse count (E point data previously specified by J81 and J82).</p>
Enter the return mode	<b>RTN</b>	<p>Starting the positioning control with the <b>RTN</b> terminal command being ON enables the return mode in which the inverter moves the control object in the reverse direction while keeping the S and E point data.</p> <p>Using the <b>RTN</b> enables the reciprocal positioning control; moving from S to E points and returning from E to S points.</p> <p>ON: Enable OFF: Disable</p>

**Note** The zero-clear function of the received pulse count (E point specified by J81 and J82), which can be triggered by turning the **SPRM** from OFF to ON, is always enabled. Take care not to zero-clear the E point mistakenly.

**Tip** When the positioning control is enabled concurrently with the speed control with EFC or frequency control with pulse rate input, the specifications of terminals [XA], [XB], [XZ], [YA], [YB], and [YZ] differ from the ones listed above. For details, refer to Section 7.8 "Assignment of EFC Terminals When Shared." (Refer to the description of function code o01.)

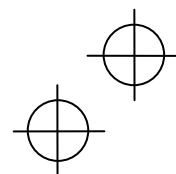
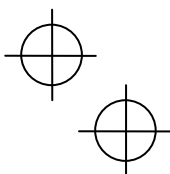

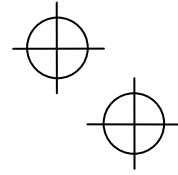
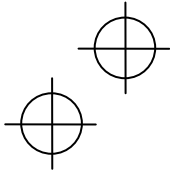

Table 7.6 Output Terminal Functions

Terminal function	Symbol	Description
Stop position override alarm	<b>OT</b>	ON conditions <ul style="list-style-type: none"> <li>• The ET time has elapsed (or after 0.5 second if ET &lt; 0.5 s) or</li> <li>• "Actual stop position – E-point" &gt; ER data.</li> </ul> OFF conditions Except the above ON conditions.
Timer output	<b>TO</b>	ON conditions Until the ET time has elapsed after the start timer (J73) starts.           OFF conditions Except the above ON conditions. When the ET is cancelled, the output frequency becomes 0 Hz, turning this signal OFF..
Positioning completed	<b>PSET</b>	ON conditions <ul style="list-style-type: none"> <li>• The ET time has elapsed (or after 0.5 second if ET &lt; 0.5 s) or</li> <li>• "Actual stop position – E-point" &gt; ER data.</li> </ul> OFF conditions Except the above ON conditions.
Current position count overflowed	<b>POF</b>	ON conditions The current position pulse count goes out of the range from -9,999,999 to +9,999,999, regardless of the ON/OFF state of the <b>SR</b> terminal command.           OFF conditions <ul style="list-style-type: none"> <li>• The position count comes within the specified range after going out of the range,</li> <li>• Any run command is turned ON with the <b>S/R</b> being ON, or</li> <li>• A Z point correction is performed.</li> </ul>

## 7.5 Function Code Details

**o01** Command/Feedback Input (Input mode)

This function code switches the feedback pulse input mode with the data in the tens place as listed below.

Table 7.7 Data for o01

Feedback pulse input mode	Data for o01
B phase pulse input	0□
Forward/reverse pulse input	1□
A/B phase pulse input	2□

**Tip** When the positioning control is enabled concurrently with the speed control with EFC or frequency control with pulse rate input, the specifications of terminals [XA], [XB], [XZ], [YA], [YB], and [YZ] differ from the ones listed above. For details, refer to Section 7.8 "Assignment of EFC Terminals When Shared." (Refer to the description of function code o01.)

## 7.6 Monitoring

The positioning control status and the pulse count can be displayed on the keypad by using Menu #3 "Drive Monitoring" as described in this section.

### 7.6.1 Monitoring items

Table 7.8 Function Code E43 (LED Monitor, Item selection)

Data for E43	Monitor items	Unit	Descriptions	Refer to:
21	Current position pulse count	p	Displays the current position pulse count.	Section 7.6.2
22	Position deviation pulse count	p	Displays the pulse count deviation between the current position and the stop position.	

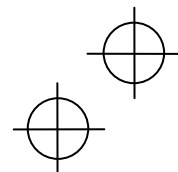
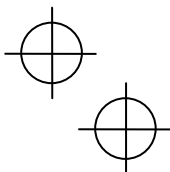

Table 7.9 Menu #3 "Drive Monitoring"

LED monitor shows:	Monitor items	Unit	Descriptions	Refer to:
3_17	E point pulse count	p	Displays the E point of positioning control in the pulse count. Turning <b>RTN</b> OFF displays E point (J81 and J82); turning it ON displays S point (J74 and J75).	Section 7.6.2
3_18	Current position pulse count	p	Displays the current position pulse count.	
3_19	Position deviation pulse count	p	Displays the pulse count deviation between the current position and S point.	
3_20	Positioning control status	--	Displays the position control status shown in Section 7.6.3 "Positioning control status."	Section 7.6.3

**7.6.2 Displaying system on the LED monitor**

The positioning control handles the pulse count ranging from 9,999,999 to +9,999,999. To display it, the 4-digit LED monitor alternately the upper and lower four digits for one second and three seconds, respectively. The lower four digits is followed by a decimal point.

Table 7.10 Displaying System for Pulse Count

Pulse count	- Running status in Running mode and running info in Programming mode on the standard keypad - Running status in Running mode on the multi-function keypad		Remarks
	Upper 4 digits	Lower 4 digits	
+9,999,999	+999	9999.	Maximum display value
+19,999	+1	9999.	The lower digits are not zero-suppressed.
+10,000	+1	0000.	
+9,999	+0	9999.	
+10	+0	0010.	
0	0	0000.	
-10	-0	0010.	
-9,999	-0	9999.	
-10,000	-1	0000.	
-19,999	-1	9999.	
-9,999,999	-999	9999.	

**7.6.3 Positioning control status**

In positioning control, the keypad can display the current control status. Figure 7.2 shows a control status transition model and Table 7.11 lists details of the status.

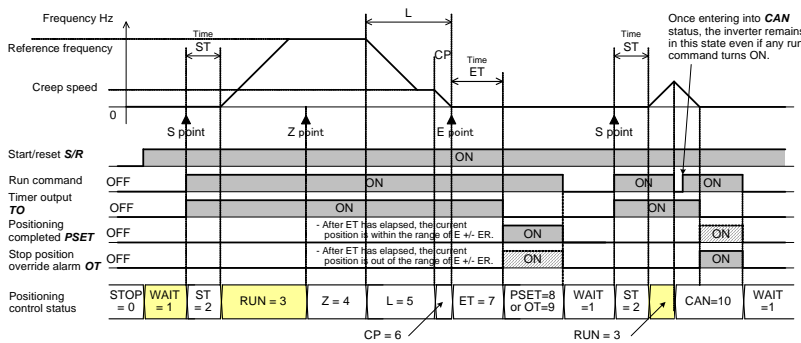

Figure 7.2 Positioning Control Status Transition Model

Table 7.11 Status Name and Number in Positioning Control

Positioning control status	Status name *1	Status number *2	Descriptions
Positioning control stopped	STOP	0	Status where <b>S/R</b> is OFF. Turning <b>S/R</b> ON shifts to "WAIT = 1" where the inverter waits for a run command. If the inverter output frequency is other than 0 Hz (Gate output) when <b>S/R</b> is turned ON, it shifts to "RUN = 3" since the start timer does not count.
Waiting for run command	WAIT	1	Status where <b>S/R</b> is ON and a run command is OFF. Turning a run command ON in this status shifts to "ST = 2." If the start timer (J73 data) is 0.0 s, the status shifts from "WAIT = 1" to "RUN = 3."
Start timer counting	ST	2	Status where <b>S/R</b> and run command are ON and the start timer is counting. Upon completion of timer count, the status shifts to "RUN = 3."
Running	RUN	3	Status until the inverter enters into a control zone "Current position $\geq$ (E point - L point)" in forward operation or "Current position $\leq$ (E point + L point)" in returning operation, or until Z point correction occurs.
Z point correction completed	Z	4	If Z point correction occurs in "RUN = 3," the inverter shifts to this status.
Running in creep speed	L	5	Status where the inverter is decelerating down to the creep speed (J80) or is running at the creep speed.
Coasting	CP	6	Status where the inverter is decelerating to a stop after entering the control zone "Current position $\geq$ (E point - CP point)" in forward operation or "Current position $\leq$ (E point + CP point)" in returning operation.
End timer counting	ET	7	Status where the end timer is counting.
Positioning control completed	PSET	8	Status where the positioning control is completed and the inverter is issuing <b>PSET</b> .
Stop position override alarm	OT	9	Status where the inverter is issuing a stop position override alarm <b>OT</b> .
Stopped by cancellation	CAN	10	If any inverter operation under positioning control is canceled during any status of "ST = 2" to "ET = 7," the inverter enters "CAN = 10." After that, the inverter turns the "Timer output" <b>TO</b> OFF and issues the "Positioning completed" <b>PSET</b> or "Stop position override alarm" <b>OT</b> . Once the inverter enters "CAN = 10", the inverter remains in this status and keeps the reference frequency at 0 Hz as long as the run command is not turned OFF.

\*1 The status name can be displayed in "Drive Monitoring" menu on the LCD monitor of the multi-function keypad.

\*2 The status number can be displayed in Menu #3 "Drive Monitoring." Display item 3\_20 on the standard keypad or on the LCD monitor of the multi-function keypad.

### 7.7 Serial Pulse Receiving Function

When the **S/R** terminal command is assigned to any digital input terminals [X]s and the serial pulse receiving function is enabled, the pulse train input from host equipment can specify the stop position (E point). Function codes J81 and J82 (Stop position) save the input pulse count.

Function code J86 specifies the pulse input mode for the serial pulse train input.

**Note** When the serial pulse receiving input shares an input terminal with other function input (e.g. Section 7.8), the inverter counts the EFC input pulse train as the serial pulse receiving input for E point pulse count only when **SPRM** is ON. On the contrary, if the serial pulse receiving input terminal is exclusively assigned, the inverter counts the input for E point data independently the ON/OFF status of **SPRM**.

## 7.8 Assignment of EFC Terminals When Shared

Table 7.12 lists input assignments for terminals [XA], [XB], [XZ], [YA], [YB] and [YZ] when the positioning control, speed control with EFC and speed control with pulse rate input share the EFC terminals

The specifications of those terminals when shared differ from the ones when not shared.

Table 7.12 Function Assignments of EFC Terminals

Pulse train input, F01/C30 data is 12.	Speed control with EFC, F42/A14 data is 3 or 4.	Positioning control, S/R is assigned.	Normal mode (Except the right column mode)	Serial pulse receiving mode, <b>SPRM</b> is ON
No	No	No	X: Pulse monitor (o01) Y: Pulse monitor (o01)	
		Yes	X: Serial pulse (J86) Y: Positioning control (o01)	
	Yes	No	X: Pulse monitor (o01) Y: Speed control (o01)	
		Yes	X: Positioning control (o01) Y: Speed control (o01)	X: Serial pulse (J86)
Yes	No	No	X: Pulse train input (o01) Y: Pulse monitor (o01)	
		Yes	X: Pulse train input (o01) Y: Positioning control (o01)	X: Serial pulse (J86)
	Yes	No	X: Pulse train input (o01) Y: Speed control (o01)	
		Yes	X: Pulse train input (o01) Y: Speed control / Positioning control (o01)	X: Serial pulse (J86)

Symbol "X" in the above table stands for EFC terminals [XA], [XB] and [XZ]. Specify their input modes with the data in the ones place of function code o01.

Symbol "Y" stands for EFC terminals [YA], [YB] and [YZ]. Specify their input modes with the data in the tens place of function code o01.

Switching to the serial pulse receiving mode with **SPRM** involves switching of the input mode, so the idle time insertion is required for a stable switching as listed below.

Table 7.13 Idle Time Required for Stable Mode Switching by **SPRM**

Function switching	When <b>SPRM</b> is turned from OFF to ON:	When <b>SPRM</b> is turned from ON to OFF:	Remarks
Positioning control to/from serial pulse receiving	Insert a minimum of 100 ms idle time before the start of the serial pulse receiving input after <b>SPRM</b> is turned ON.	Do not input the serial pulse within 100 ms before or after <b>SPRM</b> is turned OFF.	--
Pulse train input to/from serial pulse receiving		Stop the serial pulse receiving input before a minimum of 100 ms before <b>SPRM</b> is turned OFF. Start the pulse train input within 100 ms after <b>SPRM</b> is turned OFF.	During the "serial pulse receiving mode ( <b>SPRM</b> being ON) + 100 ms," the inverter holds the pulse train input count applied when <b>SPRM</b> is turned ON.

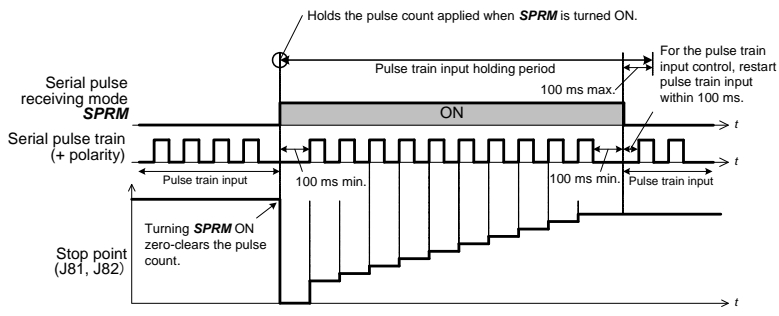
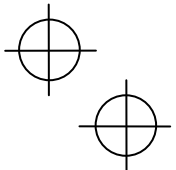
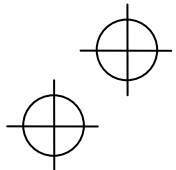
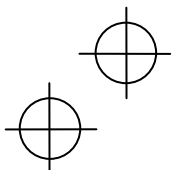
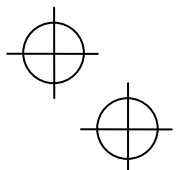

Figure 7.3 Switching the Input Mode between the Pulse Train Input and Serial Pulse Receiving Mode



## Chapter 8 PROTECTIVE FUNCTIONS

If any inverter protective function is activated to issue an alarm, the inverter displays the corresponding alarm code on the LED monitor of the keypad and shuts down its output. Accordingly, the motor coasts to a stop.

Table 8.1 lists alarm codes related to the EFC interface card. For other alarm codes, refer to the Jaguar VXR Instruction Manual, Chapter 6 "TROUBLESHOOTING."

Table 8.1 Related Alarm Codes

Alarm code	Alarm name	Alarm for:			Refer to Section:
		Frequency control with pulse rate input	Speed control	Positioning control	
<i>os</i>	Overspeed alarm	NA	Y	NA	8.1
<i>ere</i>	Excessive speed deviation alarm	NA	C	NA	8.2
<i>ero</i>	Positioning control alarm	NA	NA	Y and C	8.3

Y: Always active. The protective function for the alarm is always active when the control is enabled.  
 C: Conditionally active. The protective function for the alarm is active when the control is enabled and the protective function is enabled with the function code. The factory default is "enabled."  
 NA: Not available when the control is enabled.

### WARNING

If any of the protective functions has been activated, first remove the cause. Then, after checking that all run commands are set to off, reset the alarm. Note that if the alarm is reset when any run command is set to on, the inverter may supply the power to the motor which may cause the motor to rotate.  
**Injury may occur.**

### 8.1 Overspeed Alarm (*os*)

Table 8.2 Overspeed Alarm Specifications

Alarm code	Descriptions
<i>os</i>	<ul style="list-style-type: none"> <li>The inverter issues this alarm when the detected speed exceeds the 1.2 times the minimum value of either (1) or (2) below.               <ol style="list-style-type: none"> <li>For the selected motor, Maximum frequency (F03 or A01) + Torque limiter (Frequency increment limit for braking, H76)</li> <li>Frequency limiter, High (F15)</li> </ol> </li> <li>This protective function works when the inverter is outputting with the speed control with EFC being enabled (F42 or A14 = 3 or 4 and <b>EFC/Hz</b> is ON).</li> </ul>

### 8.2 Excessive Speed Deviation Alarm (*ere*)

Table 8.3 Excessive Speed Deviation Alarm Specifications

Alarm code	Descriptions
<i>ere</i>	<ul style="list-style-type: none"> <li>This protective function recognizes a EFC error by software based on the relationship between the speed command and the detected speed.</li> <li>When the speed deviation between the speed command and the detected speed has exceeded the excessive speed deviation level specified by o17 during the period longer than the timer setting specified by o18, the protective function issues this alarm.</li> <li>This protective function provides two choices--"Stop running" (o19 = 1 or 2) and "Continue to run" (o19 = 0) when it is activated. When the latter is selected, the inverter continues to run with output to terminal [Y] without issuing an alarm.</li> <li>This protective function works when the inverter is outputting with the speed control with EFC being enabled (F42 or A14 = 3 or 4 and <b>EFC/Hz</b> is ON). It does not, however, during DC braking or idling due to overload.</li> </ul>

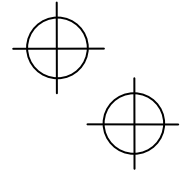
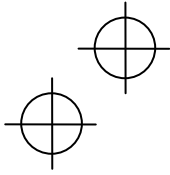

### 8.2.1 Function codes

Table 8.4 lists function codes related to excessive speed deviation alarms.

Table 8.4 Related Function Codes

Code	Name	Data setting range	Unit	Default setting	Change when running
o17	Excessive Speed Deviation Level	0 to 50	%	10	Y
o18	Excessive Speed Deviation Timer	0.0 to 10.0	s	0.5	Y
o19	EFC Error Processing	0: Continue to run 1: Stop running (Alarm mode 1) 2: Stop running (Alarm mode 2)	-	2	N
E20	Terminal [Y1] Function	76(1076): EFC error signal <i>EFC-ERR</i>	-	0	N
E21	Terminal [Y2] Function			7	
E27	Terminal [30A/B/C] Function			99	

### 8.2.2 Excessive speed deviation detection

Table 8.5 lists the relationship between EFC error detection conditions and error processing (o19.)

Table 8.5 Data for o19 Data and Error Detection

Data for o19	Conditions determining the excessive speed deviation	Alarm	<i>EFC-ERR</i> output
0: Continue to run	Any status of ① to ⑥ in Figure 8.1 is kept exceeding the timer setting specified by o18.	None	Active
1: Stop running (Alarm mode 1)		<i>ere</i>	Inactive
2: Stop running (Alarm mode 2)	Any status of ① to ⑧ in Figure 8.1 is kept exceeding the timer setting specified by o18.		

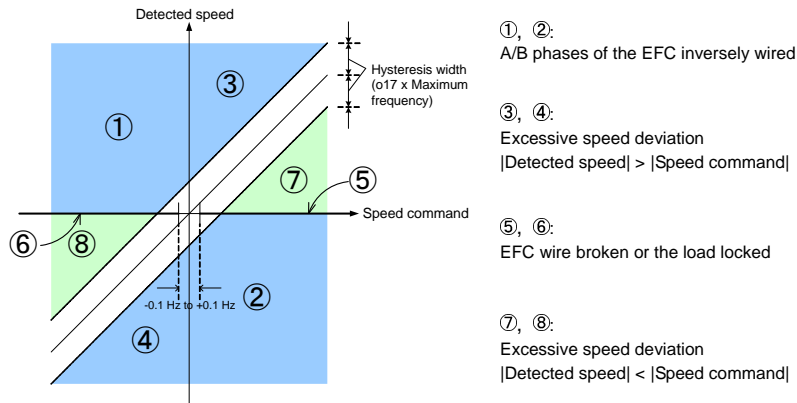
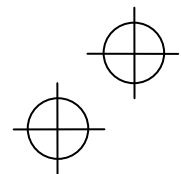
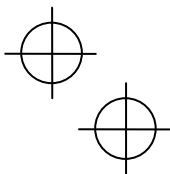

Figure 8.1 Excessive Speed Deviation Detection and Speed Command



When *ere* alarm occurs, the current error factor (any of ① to ⑧) can be displayed on the keypad by using Menu #6 "Alarm Information," Item 6\_21 "Error sub code." The relationship between the error code and error factors in Figure 8.1 are: 1 for ① or ②, 3 for ③ or ④, 5 for ⑤ or ⑥, and 7 for ⑦ or ⑧. For details, refer to the inverter's instruction manual. (Refer to the description of function code E52.)



### 8.3 Positioning Control Alarm (*ero*)

Table 8.6 Positioning Control Alarm Specifications

Alarm code	Descriptions
<i>ero</i>	<ul style="list-style-type: none"> <li>When the protective function detects an undervoltage during operation in positioning control, it issues this alarm. This alarm is contained in alarm category "Y" in Table 8.1, so it cannot be disabled by any function code.</li> </ul>
	<ul style="list-style-type: none"> <li>This protective function recognizes a EFC error by software based on the position pulse feedback status against its output frequency.</li> <li>This alarm occurs if:               <ol style="list-style-type: none"> <li>The position pulse input count does not change when the inverter output frequency has exceeded the hysteresis width (specified by E30 Frequency Arrival, for 2.5 Hz min.) during the period longer than the timer setting specified by o18.</li> <li>The polarity is being incongruent between the inverter output frequency and feedback position pulse when the inverter output frequency has exceeded the hysteresis width (specified by E30 Frequency Arrival, for 2.5 Hz min.) during the period longer than the timer setting specified by o18.</li> </ol> </li> <li>If the o18 data (Excessive speed deviation timer is set to 0.0 s (Disable detection), however, any alarm will not occur in both cases (1) and (2). This alarm is contained in alarm category "C" in Table 8.1.</li> </ul>

#### 8.3.1 Function codes

Table 8.7 lists function codes related to positioning control alarms.

Table 8.7 Related Function Codes

Code	Name	Data setting range	Unit	Default setting	Change when running
o18	Excessive Speed Deviation Timer	0.0 to 10.0	s	0.5	Y
E30	Frequency Arrival (Hysteresis width)	0.0 to 10.0	Hz	2.5	Y
J88	Positioning Control (Position detection direction)	0: Forward direction 1: Reverse direction (Inverts the current direction (x -1))	-	0	N



Alarm (2) in Table 8.6 could occur due to wrong wiring of the EFC. Using J88 can correct the direction without rewiring.

# VXR-EFC Instruction Manual (Additional)

This instruction manual contains the additional information about VXR-EFC

## 1. Acceptance Inspection

The model name "OPC-E1-PG3" is printed on the VXR-EFC interface card.

## 2. Applicable Inverter ROM Version

This option card is applicable with following inverter ROM version.

Product Version of VXR-EFC	Applicable inverter ROM Version (5_14)
(None)	0700 or later
A	0800 or later

To check the product version of VXR-EFC, refer to the alphabet of last digit of marking of the product.

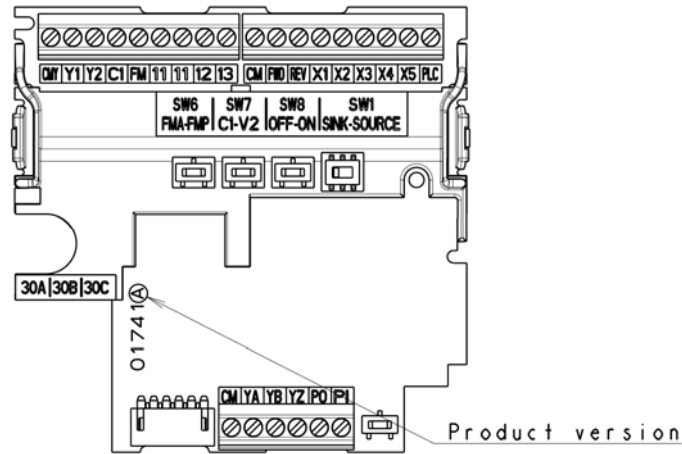

To check the inverter ROM version, use Menu #5 "Maintenance Information" on the keypad. (Refer to the Jaguar VXR Instruction Manual, Chapter 3, Section 3.4.6 "Reading maintenance information.")

### 3. EFC Specifications

**Table 2.1 Specifications of Applicable EFC and EFC Interface Card**

Item		Specifications
Applicable EFC	Encoder system	Incremental system
	Pulse resolution	20 to 3000 P/R
	Input power requirements	12Vdc±10%/80mA or less, 15Vdc±10%/60mA or less
EFC power supply	Internal power supply	12Vdc±10%/80mA or 15Vdc±10%/60mA
	External power supply	12Vdc±10%/more than 80mA or 15Vdc±10%/more than 60mA
Output signal	Open collector (pull-up resistor: 2350Ω) Complementary (totem-pole push-pull) voltage output	
Max. input frequency	Open collector	cable up to 30m : 100kHz, up to 100m : 30kHz
	Complementary	cable up to 30m : 30kHz

Note 1 : When the PG power is 200mA or more, use an external power supply.

Note 2 : The external power supply should satisfy the voltage specifications of the PG.

### 4. Terminal Specifications

**Table 3.1 Terminal Specifications**

Terminal symbol	Name	Functions
PI	External power supply input	Power input terminal from the external device External power supply capacity: 12Vdc±10%/80mA or more or 15Vdc±10%/60mA or more
PO	Power supply for EFC	Power output terminal 12Vdc±10%/80mA or 15Vdc±10%/60mA
CM	EFC common	Common terminal for power supply and PG input
YA	A phase pulse input Y	Assigned functions as follows according to functions. • For commands (Same as XA, XB, XZ at p.1-5, Table1.4) • For feedback (Same as YA, YB, YZ at p.1-5, Table1.4)
YB	B phase pulse input Y	
YZ	Z phase pulse input Y	

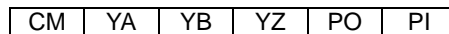

**Figure 3.1 Terminal layout**

Select internal power supply for EFC (12V/15V) by SW12 on the interface card.

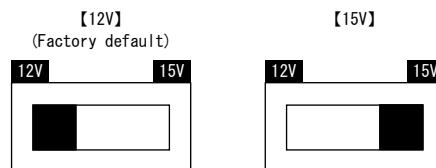

**Figure 3.2 Select internal power supply**

## 5. Function Specifications

VXR-EFC changes into the following specification compared with VXR-EFC-5V.

### ■ Chapter 6 SPEED CONTROL (P.6-2)

### ■ Chapter 7 POSITIONING CONTROL (P.7-6)

This function code switches the feedback pulse input mode with the data in the ones place as listed below. Setting of tens digit of o01 is ignored and don't reflect to any operating.

**Table 4.1 Data for o01**

Feedback pulse input mode	Data for o01
B phase pulse input	0
Forward/reverse pulse input	1
A/B phase pulse input	2

### ■ Chapter 6 SPEED CONTROL (P.6-2,P.6-3,P.6-4)

The function codes of the feedback input setting of the speed control with PG are a table below.

**Table 4.2 Function Codes**

Code		Name	Data setting range	Unit	Default setting	Change when running
VXR-EFC5V	VXR-EFC					
<b>o09</b>	<b>o05</b>	Feedback Encoder pulse resolution) Input (Filter time constant) (Pulse count factor 1) (Pulse count factor 2)	20 to 3600	P/R	1024	N
<b>o10</b>	<b>o06</b>		0.000 to 5.000	s	0.005	Y
<b>o11</b>	<b>o07</b>		1 to 9999	-	1	N
<b>o12</b>	<b>o08</b>		1 to 9999	-	1	N

### ■ Chapter 7 POSITIONING CONTROL (P.7-9)

Table 4.3 lists input assignments for terminals [XA], [XB] and [XZ] when the positioning control, speed control with EFC and speed control with pulse rate input share the EFC terminals. The specifications of those terminals when shared differ from the ones when not shared.

**Table 4.3 Function Assignments of PG Terminals**

Pulse train input, F01/C30 data is 12.	Speed control with PG, F42/A14 data is 3 or 4.	Positioning control, <b>S/R</b> is assigned.	Normal mode (Except the right column mode)	Serial pulse receiving mode, <b>SPRM</b> is ON
No	No	No	Pulse monitor	
		Yes	Positioning control	Serial pulse (J86)
	Yes	No	Speed control	
		Yes	Speed control / Positioning control	
Yes	No	No	Pulse train input	
		Yes	Pulse monitor	
	Yes	No	(Pg alarm happens.)	
		Yes		

## 6. Terminal "PLC"

Terminal "PLC" can supply source current of digital input terminals X1-X5,FWD,REV only when digital input terminals are used as source logic.

 Don't use terminal "PLC" in a purpose except the above. Otherwise the inverter may damaged.

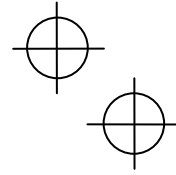
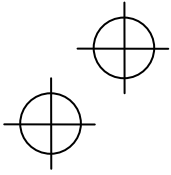

---

**EFC Interface Cards “VXR-EFC” & “VXR-EFC-5V”**

**Instruction Manual**

First Edition, June 2006  
IMO Precision Controls Ltd.

---

The purpose of this instruction manual is to provide accurate information in handling, setting up and operating of the EFC interface card. Please feel free to send your comments regarding any errors or omissions you may have found, or any suggestions you may have for generally improving the manual.

In no event will IMO Precision Controls Ltd., Ltd. be liable for any direct or indirect damages resulting from the application of the information in this manual.

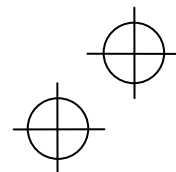
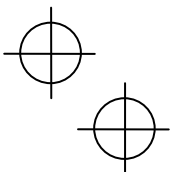

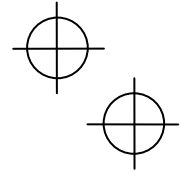
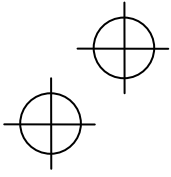

---

## **IMO Precision Controls Ltd.**

Unit 15, 1000 North Circular Road, Staples Corner, London, NW2 7JP, England  
Phone: +44 208 452 6444 Fax: +44 208 450 2274

URL <http://www.imopconline.com>

---

2006-05-19 S.Mc

