

OPTIPAD

TFT Remote Keypad

IP55

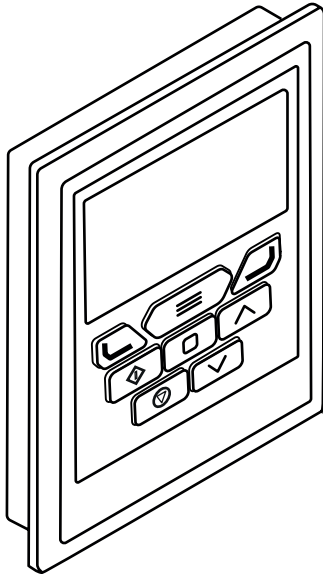

Installation and Operating Instructions

Mechanical Installation

Dimensions

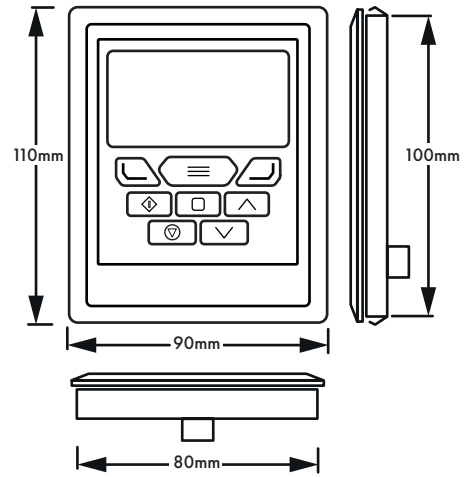

Through Panel Mount

The panel on to which the Optipad is to be mounted should be cut out in accordance with the diagram below.

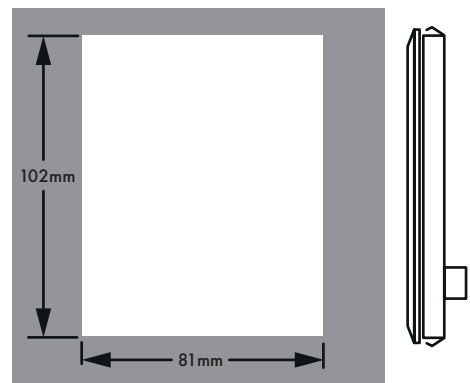

General Specification

Compatible Drives:	ODE-2, ODE-3, ODP-2, ODL-2, ODV-3
Signal Interface:	Standard 8-way RJ45 connector
Supply Input:	24V + / - 10%, DC, 30mA
RS485 signal:	Industry standard 2-wire +5V differential
Environmental:	Operational: -10 ... 50°C
	Storage: -40°C ... 60°C
Relative Humidity	< 95% (non condensing)
Protection rating:	IP55
Max cable length:	25m / 82.5ft shielded twisted pair

Electrical Installation

Cable Requirements

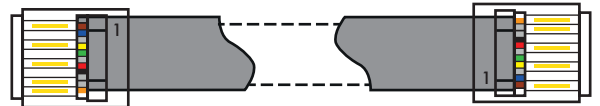

CAUTION! Incorrect cable connection may damage the drive. Extra care should be taken when using third party cable.

Allowed System Configurations

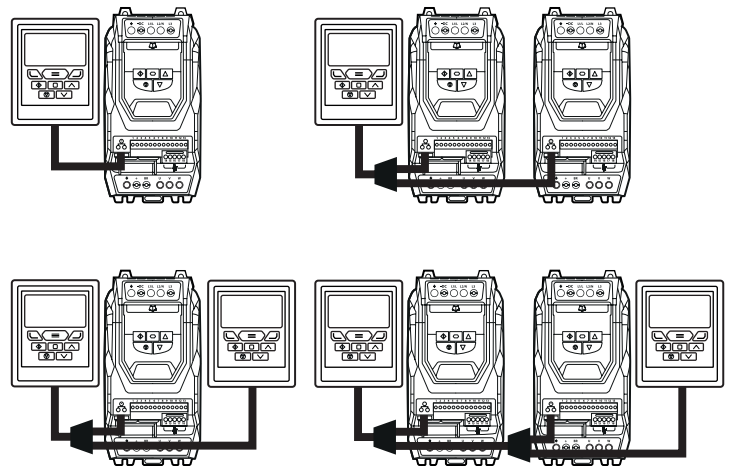

Different drive models can be used on the same Optipad network provided a unique communications address is assigned to each.

NOTE Cannot be used with Master – Slave or Cascade Control

Easy Startup

To setup the Optidrive communication address

By default, the Optipad will try to communicate with the drive that has Address 1 in the network after powering up for the first time.

The Optipad will display "Scanning for Drive 01." after power up, which indicates that the Optipad is searching for the drive with the correct drive address in the network. Once the drive has been found, the message "Load..." will be displayed on the Optipad, which indicates that the Optipad is reading the configuration information from the drive. Usually it will take 1~2 seconds for the Optipad to read this information. After the data has been loaded, the Optipad will display the drive real time status.

NOTE In the case where the keypad is connected to a drive where the network address is not 1, the following steps can be used to set the address of the drive

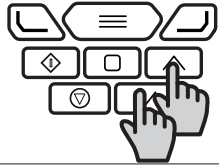
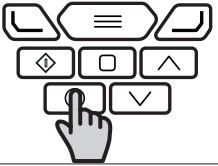
Select Drive Address 01	Select Drive Address 01
	
Use the Up and Down arrows to select the address.	Press the Stop button once address has changed to match the connected drive.

Working with Multiple Drive Networks

When the Optipad is used on networks with multiple drives, the user can change the drive address to set up communication with another drive in the same drive network at anytime.

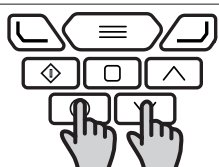
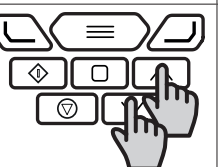
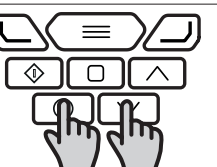
Select Drive Address xx	Select Drive Address xx	Select Drive Address xx
		
Briefly press the Stop and Down keys to display the above message.	Use the Up and Down arrows to select the desired address.	After selecting the new address, press the Stop and Down keys to establish communications with the drive.

NOTE For detailed parameter listing and functional setup, please refer to the corresponding Optidrive user guide

Networks with 2 Optipads connected

A maximum of 2 Optipads can be connected within the same drive network to communicate with the same drive or different drives.

When using two Optipads simultaneously on a network, the user must change the Optipad Device Number on the second Optipad to ensure correct operation. All Optipad units are set to Device Number 1 by default.

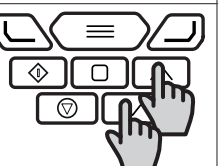
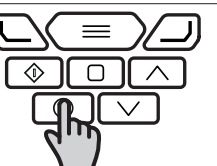
Select OptiPad ID xx	Select OptiPad ID xx	Select OptiPad ID xx
		
To change the Device Number, press the Navigate, Stop and Down keys together.	Use the Up and Down arrows to select the desired OptiPad Number (1 or 2).	Press the Stop key to return to normal operation.

NOTE Once the User has set the Optipad as Device Number 2, Optistore or OptiTools software cannot be used on the same drive network. The Optipad Device Address should only be changed to 2 if 2 Optipad units are connected on a network. An Optipad with Device Number 1 must always be present for the network to function correctly.

Changing the Display Language

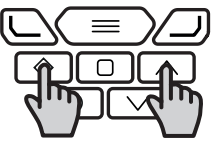
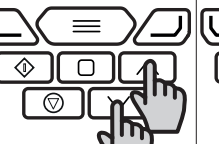
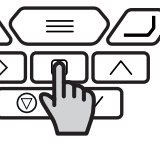
STOP	Select Language Español Deutsch English	Select Language Español Deutsch English
		
Hold down the Start and Up keys for >1s	Use the Up and Down arrows to select a language.	Press the Navigate button to select.

Drive Fault Messages and Trip Codes

See Optidrive User Guide for further information.

Optipad Display Messages

Optipad uses various display messages to indicate different working status. See the following table for more information.

Message	Explanation
Scanning for Drive xx	The Optipad is searching for the drive with address 'xx' in the network.
Load...	The Optipad has found the drive in the network and is loading the initialisation information from the drive.
SC-OBS	The communication link between the Optidrive and Optipad has failed.
Select Language	Displayed in the language selection screen, with a list of available languages. Press the Navigate key to select a language
Select drive address xx	Displayed when selecting the address of the Optidrive that the Optipad should try to communicate with. Press the Stop key to select the drive address.
Select OptiPad ID	Displayed when selecting the Optipad ID (1 or 2) so that two Optipads can be connected to a single drive, or network of multiple drives.

Troubleshooting

Symptom	Explanation
Select drive address xx displayed after 'SCAN..' message	The Optipad failed to successfully communicate with the specified drive address in the network. Check that the RJ45 data cable connection is correct. Check that the drive with address XX is available in the network. If XX > 1 and only one Optipad is connected, then check the Optipad device number, make sure the number is 1.
Display 'Err-id' on power up	This normally occurs when there are two Optipad units in the same drive network and both of them have the same device number. Check and change the device number of one Optipad.
Display 'Err-id' during normal operation	This normally occurs when the user plugs a second Optipad into the drive network. Change the device number of one of the Optipad units.
Display 'SC-OBS'	Communication link between the Optipad and Optidrive has failed during operation. Check the electrical connection, and make sure the cable is connected correctly between the Optipad and the drive. Press 'STOP' button to enable the Optipad to search for the drive again.