

TECHNICAL DATA

Three Phase Electric Motors - Aluminum Frame
 UM3A 90L-4
 1.5 kW / 2 Cv
 1430 RPM

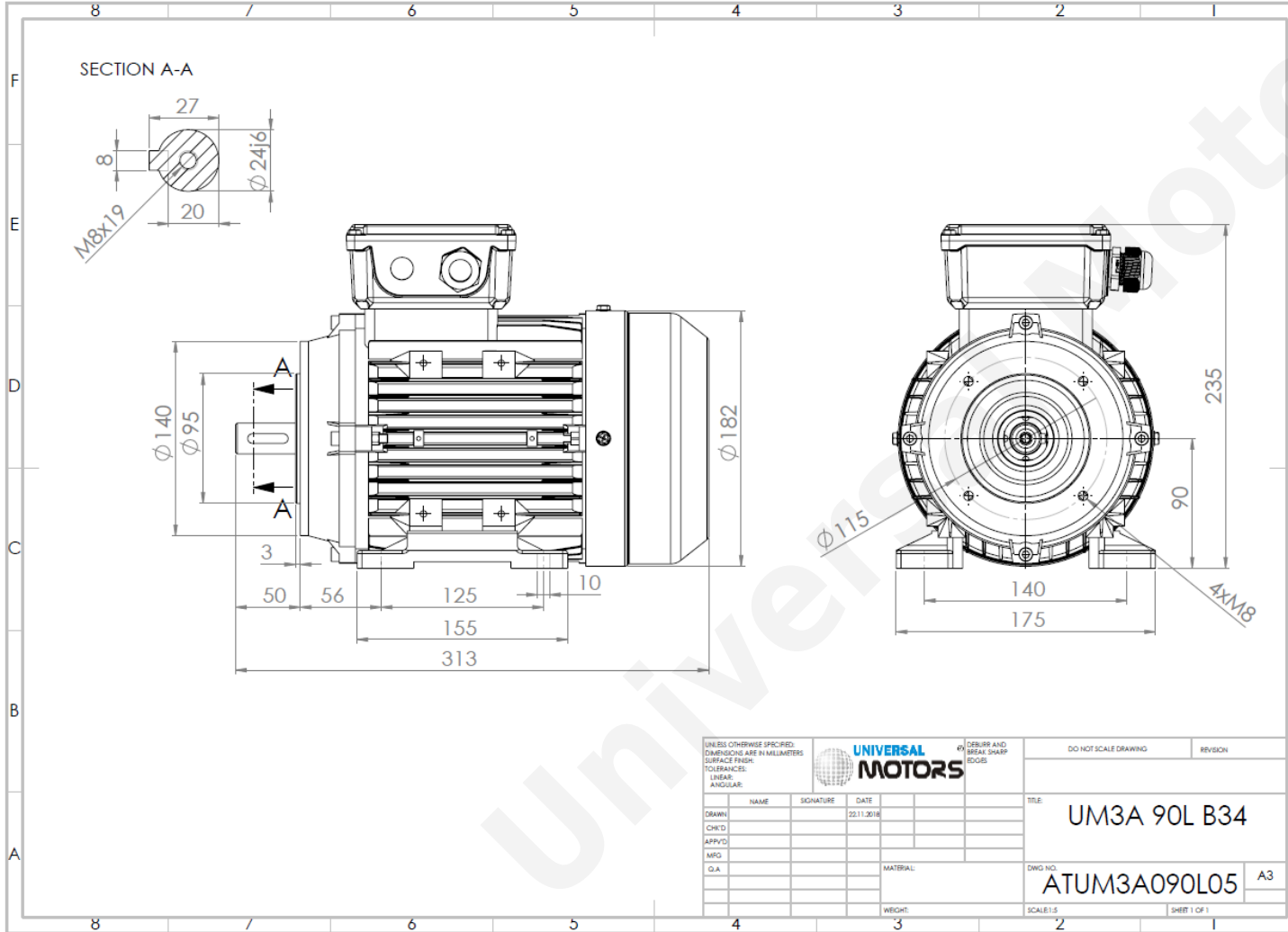

Motor type:	UM3A 90L-4
Output:	1.5 kW / 2 Cv
Speed (min ⁻¹):	1430 RPM
Voltage:	400 V
Frequency:	50 Hz
Current:	3.4 A
Power factor (Cos ϕ):	0.75
Poles:	4
Insulation class:	F
Temperature rise Class:	B
Efficiency 50%:	83.2 %
Efficiency 75%:	84.0 %
Efficiency 100%:	85.3 %
Torque:	10.0 N.m
Tstarting/Tnominal:	2.3
Istarting/Inominal:	6.9
Tmaximum/Tnominal:	2.3
Noise:	66 Db(A)
Weight:	17 Kg
Bearing DE:	6205 2Z C3
Bearing NDE:	6205 2Z C3

Regime - S1

Altitude - 1000m

Environment Temperature - 40°C

CONTACTS:

Universal Motors UK, Ltd
 Unit E2, Meltham Mills Industrial Estate, Meltham Mills Road, Meltham, Holmfirth
 West Yorkshire HD9 4AR, U.K

Tel: +44(0) 1484 660 222

Fax: +44(0) 1484 660 333

Mail: enquiries@universalmotors-group.co.uk

* References applied only in the UK