

1 2 3 4 5 6

A

B

C

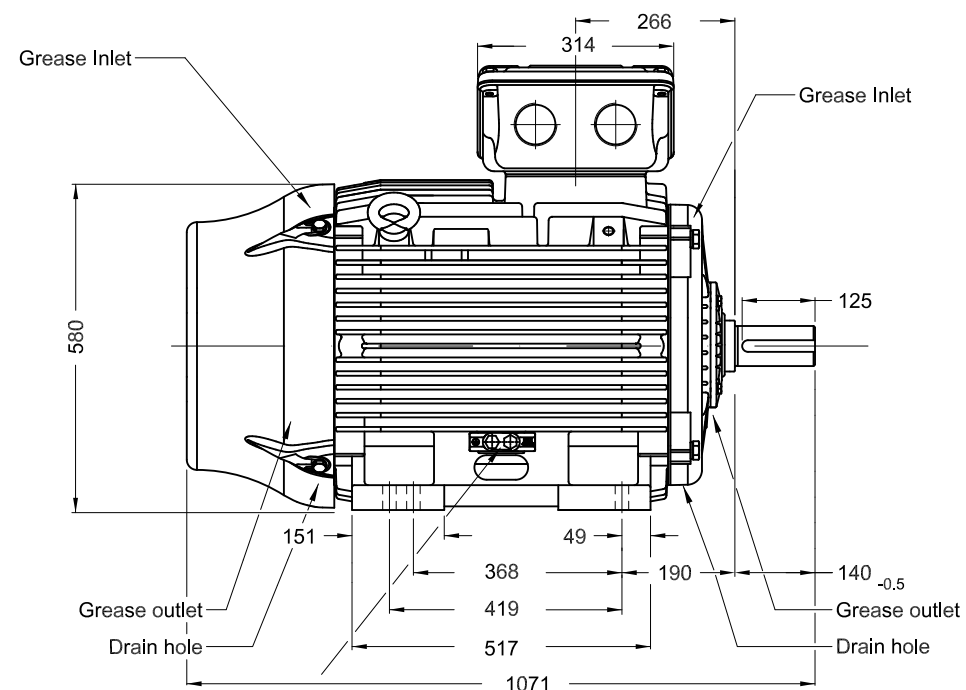
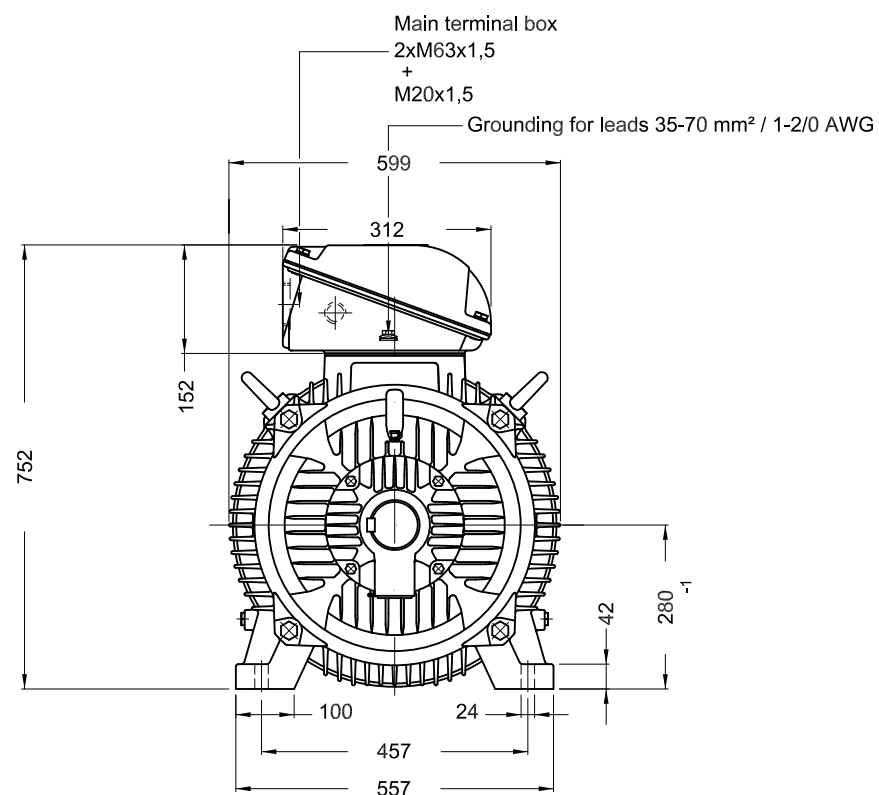

D

E

Without vertical jackscrews
 Color RAL 5009
 Painting plan 203A
 Mounting B3T

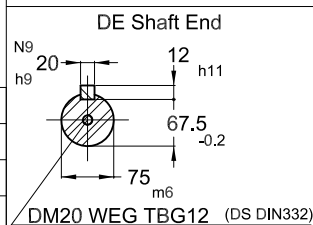

45 kW 06 Poles 50 Hz A

ECM	LOC	SUMMARY OF MODIFICATIONS	EXECUTED	CHECKED	RELEASED	DATE	VER
EXECUTED		THREE PHASE W22 MOTOR - PREMIUM EFF					
CHECKED		FRAME 280S/M IP55 TEFC					
RELEASED							
REL DT.	WMO	Jaragua do Sul	Product Engineering	SHEET	1 / 1		

PREVIEW

