

# Overloads

RW Series - Bi-Metallic

## Thermal Overload Relays

An extended operational service life is one of the main features you can find in RW overload relays. WEG's RW Thermal Overload Relays are designed for use with, and as perfect complement to, WEG contactors. Effectively, RW overload relays can be mounted directly under WEG contactors, assuring electrical and mechanical operation as an open across-the-line starter. Accessories are also available for separate mounting.



General Information

Circuit Protection

Disconnect Switches

Motor Protectors

Contactors

Overloads

Enclosed Starters

Relays

Pushbuttons and Pilot Lights

Terminal Blocks

Power Factor Correction

Appendix A

Appendix B

### Standard Features

- 2 and 3 pole versions available
- Direct mounting to WEG contactors with no accessory. (Accessories also available for separate mounting)
- Phase loss & current unbalance sensitivity protection
- Class 10 Trip characteristics
- Selectable RESET button (auto or manual)
- Isolated 1NO & 1NC auxiliary contacts

### RW Series Catalog Number Sequence

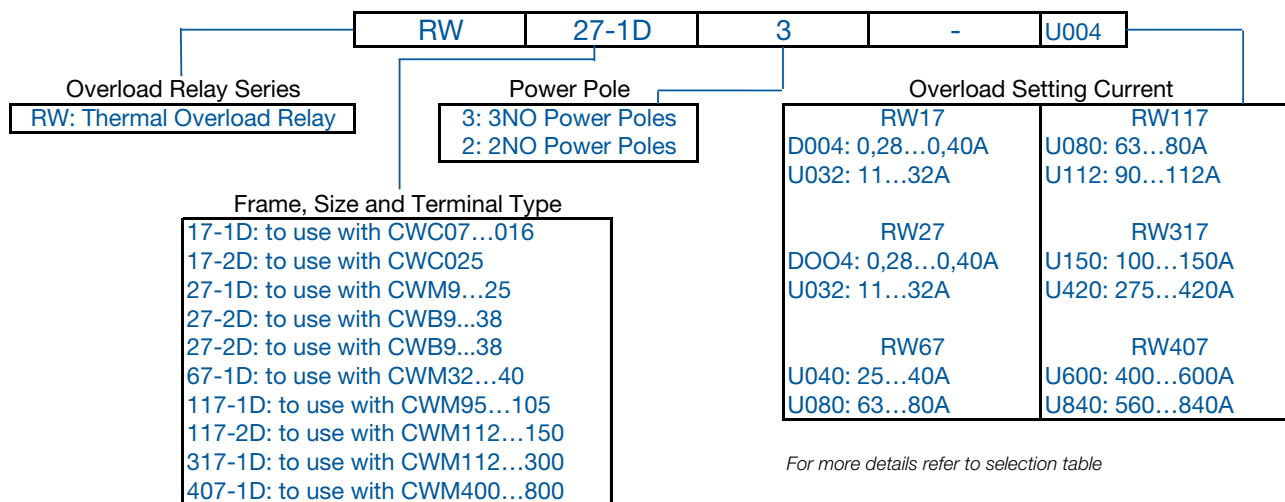

For more details refer to selection table

Chart intended for reference only and not to create part numbers.



### Multifunction Reset / Test Button

The thermal overload relay has a multifunction **RESET / TEST** button that can be set in four different positions:

**A** - Automatic **RESET** only;

**AUTO** - Automatic **RESET / TEST**;

**HAND** - Manual **RESET / TEST**;

**H** - Manual **RESET** only.

In **HAND** and **AUTO** positions, when **RESET** button is pressed, both NO (97-98) and NC (95-96) contacts change states.

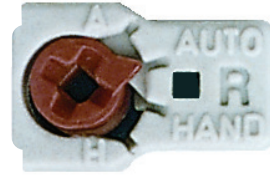

### Operation description:

In H (manual RESET only) or A (automatic RESET only) position, the test function is blocked. However in the positions HAND (manual RESET / TEST) or AUTO (automatic RESET / TEST) it is possible to simulate the test and the trip functions by pressing the RESET button.

When set in the H or HAND position the RESET button must be pressed manually to reset the overload relay after a tripping event. On the other hand, when set in A or AUTO position, the overload relay will reset automatically after a tripping event.

The H, HAND, AUTO and A function setting is carried out by rotating without pressing the red button and placing it on the desired position of the RESET button.

When changing from HAND to AUTO, the RESET button must be slightly pressed while the red button is rotated.

Functions	H	HAND	AUTO	A
Relay reset	Manual1)	Manual1)	Automatic	Automatic
Auxiliary contact trip test 95-96 (NC)	Function is disabled	Test is allowed	Test is allowed	Function is disabled
Auxiliary contact trip test 97-98 (NO)	Function is disabled	Test is allowed	Test is allowed	Function is disabled

*Note: 1) A recovery time of a few minutes is necessary before resetting the thermal overload relay.*

### Recovery Time

The RW thermal overload relays have thermal memory.

After tripping due to an overload, the relay requires a certain period of time for the bimetal strips to cool down. This period of time is so-called recovery time. The relay can only be reset once it has cooled down. The recovery time depends on the characteristic tripping curves and the level of the tripping current. After tripping due to overload, the recovery time allows the load to cool down.

### Operation in the Output Side of Frequency Inverters

The RW27-2D thermal overload relays are designed for operation on 50/60 Hz up to 400 Hz and the tripping values are related to the heating by currents within this frequency range. Depending on the design of the frequency inverter, the switching frequency can reach several kHz and generate harmonic currents at the output that result in additional temperature rise in the bimetal strips. In such applications, the temperature rise not only depends on the rms value of the current, but on the induction effects of the higher frequency currents in the metal parts of the device (skin effect caused by eddy currents).

Due to these effects, the current settings on the overload relay should be higher than the motor rated current.

### Dial FLA Setting

The trip-current is set via an infinitely adjustable dial designed with the motor's full load current (FLA) in mind.

### Temperature Compensation

Because RW overload relays include a fourth bimetallic strip in addition to the three that are directly heated by the motor current, ambient temperature variations in the range of -4°F to +140°F are no obstacle for accurate protection of your motors even in the toughest conditions.

### Phase Failure Sensitivity

WEG overload relays include phase failure sensitivity protection as a standard. This feature ensures fast tripping in case of phase loss, protecting your motor and avoiding expensive repairs/corrective maintenance.

General Information

Circuit Protection

Disconnect Switches

Motor Protectors

Contactors

Overloads

Enclosed Starters

Relays

Pushbuttons and Pilot Lights

Terminal Blocks

Power Factor Correction

Appendix A

Appendix B

# Overloads

## RW Series - Bi-Metallic

### For use with CWC and CWM Contactors

### Three-pole Thermal Overload Relay Class 10

- Adjustable tripping current
- Phase-loss sensitivity
- Tripping class 10
- Auxiliary contacts 1NO + 1NC
- Temperature compensation from -40F to +140F
- Hand/Auto/Reset button

Matching Contactor	Setting Range [A]		Max. Fuse [A]	Catalog Number	List Price	Multiplier
	Min.	Max.				
CWC07...CWC016 CWCA0 (Mini-contactor)	0.28	0.40	15	<a href="#">RW17-1D3-D004</a>	\$46	Z2
	0.40	0.63	15	<a href="#">RW17-1D3-C063</a>	\$46	
	0.56	0.80	15	<a href="#">RW17-1D3-D008</a>	\$46	
	0.80	1.20	15	<a href="#">RW17-1D3-D012</a>	\$46	
	1.20	1.80	15	<a href="#">RW17-1D3-D018</a>	\$46	
	1.80	2.80	15	<a href="#">RW17-1D3-D028</a>	\$46	
	2.80	4.00	15	<a href="#">RW17-1D3-U004</a>	\$46	
	4.00	6.30	25	<a href="#">RW17-1D3-D063</a>	\$46	
	5.60	8.00	30	<a href="#">RW17-1D3-U008</a>	\$46	
	7.00	10.0	40	<a href="#">RW17-1D3-U010</a>	\$46	
CWC025 (Mini-contactor)	8.00	12.5	50	<a href="#">RW17-1D3-D125</a>	\$46	
	10.0	15.0	60	<a href="#">RW17-1D3-U015</a>	\$46	
CWM9...CWM40 CWM9N...CWM32N	11.0	17.0	60	<a href="#">RW17-1D3-U017</a>	\$46	
	15.0	23.0	90	<a href="#">RW17-2D3-U023</a>	\$46	
	22.0	32.0	100	<a href="#">RW17-2D3-U032</a>	\$46	
	0.28	0.40	15	<a href="#">RW27-1D3-D004</a>	\$50	
	0.40	0.63	15	<a href="#">RW27-1D3-C063</a>	\$50	
	0.56	0.80	15	<a href="#">RW27-1D3-D008</a>	\$50	
	0.80	1.20	15	<a href="#">RW27-1D3-D012</a>	\$50	
	1.20	1.80	15	<a href="#">RW27-1D3-D018</a>	\$50	
	1.80	2.80	15	<a href="#">RW27-1D3-D028</a>	\$50	
	2.80	4.00	15	<a href="#">RW27-1D3-U004</a>	\$50	
CWM32...CWM40 CWM32N	4.00	6.30	25	<a href="#">RW27-1D3-D063</a>	\$50	
	5.60	8.00	30	<a href="#">RW27-1D3-U008</a>	\$50	
	7.00	10.0	40	<a href="#">RW27-1D3-U010</a>	\$50	
	8.00	12.5	50	<a href="#">RW27-1D3-D125</a>	\$50	
	10.0	15.0	60	<a href="#">RW27-1D3-U015</a>	\$50	
	11.0	17.0	60	<a href="#">RW27-1D3-U017</a>	\$50	
	15.0	23.0	90	<a href="#">RW27-1D3-U023</a>	\$50	
	22.0	32.0	90	<a href="#">RW27-1D3-U032</a>	\$50	
	25.0	40.0	90	<a href="#">RW67-1D3-U040</a>	\$87	
	32.0	50.0	125	<a href="#">RW67-1D3-U050</a>	\$94	
CWM50...CWM80 CWM50N	25.0	40.0	90	<a href="#">RW67-2D3-U040</a>	\$95	
	32.0	50.0	125	<a href="#">RW67-2D3-U050</a>	\$95	
	40.0	57.0	150	<a href="#">RW67-2D3-U057</a>	\$95	
	50.0	63.0	150	<a href="#">RW67-2D3-U063</a>	\$95	
	57.0	70.0	175	<a href="#">RW67-2D3-U070</a>	\$112	
CWM95...CWM105 CWM95N	63.0	80.0	175	<a href="#">RW67-2D3-U080</a>	\$112	
	63.0	80.0	200	<a href="#">RW117-1D3-U080</a>	\$150	
	75.0	97.0	225	<a href="#">RW117-1D3-U097</a>	\$192	
CWM112...CWM150 CWM150N	90.0	112	250	<a href="#">RW117-1D3-U112</a>	\$192	
	75.0	97	225	<a href="#">RW117-2D3-U097</a>	\$232	
	90.0	112	250	<a href="#">RW117-2D3-U112</a>	\$232	
CWM112...CWM300 CWM300N	100	150	300	<a href="#">RW317-1D3-U150</a>	\$285	
	140	215	350	<a href="#">RW317-1D3-U215</a>	\$285	
	200	310	500	<a href="#">RW317-1D3-U310</a>	\$320	
CWM400...CWM800	275	420	700	<a href="#">RW317-1D3-U420</a>	\$320	
	400	600	1000	<a href="#">RW407-1D3-U600</a>	\$690	
	560	840	1250	<a href="#">RW407-1D3-U840</a>	\$690	

Note: RW117-2D, RW317-1D and RW407-1D are for separate mounting -  
Connector links for contactors CWM112...CWM300 are available as an accessory on page B-59.

### For use with CWB Contactors

### Three-pole Thermal Overload Relay Class 10

- Adjustable Trip Current
- Phase Loss Sensitivity
- Trip Class 10
- Built-In Auxiliary Contacts: 1NO + 1NC
- Ambient Temperature Compensation: -4°F to +140°F
- Multi-Function Button: Hand/Auto/Reset

Matching Contactor	Setting Range [A]		Max. Fuse [A]	Catalog Number	List Price	Multiplier
	Min.	Max.				
CWB9 - CWB38	0.28	0.40	15	<a href="#">RW27-2D3-D004</a>	\$50	22
	0.40	0.63	15	<a href="#">RW27-2D3-C063</a>	\$50	
	0.56	0.80	15	<a href="#">RW27-2D3-D008</a>	\$50	
	0.80	1.20	15	<a href="#">RW27-2D3-D012</a>	\$50	
	1.20	1.80	15	<a href="#">RW27-2D3-D018</a>	\$50	
	1.80	2.80	15	<a href="#">RW27-2D3-D028</a>	\$50	
	2.80	4.00	15	<a href="#">RW27-2D3-U004</a>	\$50	
	4.00	6.30	25	<a href="#">RW27-2D3-D063</a>	\$50	
	5.60	8.00	30	<a href="#">RW27-2D3-U008</a>	\$50	
	7.00	10.0	40	<a href="#">RW27-2D3-U010</a>	\$50	
	8.00	12.5	50	<a href="#">RW27-2D3-D125</a>	\$50	
	10.0	15.0	60	<a href="#">RW27-2D3-U015</a>	\$50	
	11.0	17.0	60	<a href="#">RW27-2D3-U017</a>	\$50	
	15.0	23.0	90	<a href="#">RW27-2D3-U023</a>	\$50	
	22.0	32.0	90	<a href="#">RW27-2D3-U032</a>	\$50	
32.0	40.0	90	<a href="#">RW27-2D3-U040</a>	\$60		

- General Information
- Circuit Protection
- Disconnect Switches
- Motor Protectors
- Contactors
- Overloads
- Enclosed Starters
- Relays
- Pushbuttons and Pilot Lights
- Terminal Blocks
- Power Factor Correction
- Appendix A
- Appendix B

## RW Series - Bi-Metallic

**For use with CWC and CWM Contactors**  
**Two-pole Thermal Overload Relays Class 10**  
**(used for single phase applications)**

- Adjustable tripping current
- Phase-loss sensitivity
- Tripping class 10
- Auxiliary contacts 1NO + 1NC
- Temperature compensation from -40F to +1400F
- Hand/Auto/Reset button

Matching Contactor	Setting Range [A]		Max. Fuse [A]	Catalog Number	List Price	Multiplier
	Min.	Max.				
CWM9...CWM40	0.28	0.40	15	<a href="#">RW27-1D2-D004</a>	\$40	Z2
	0.40	0.63	15	<a href="#">RW27-1D2-C063</a>	\$40	
	0.56	0.80	15	<a href="#">RW27-1D2-D008</a>	\$40	
	0.80	1.20	15	<a href="#">RW27-1D2-D012</a>	\$40	
	1.20	1.80	15	<a href="#">RW27-1D2-D018</a>	\$40	
	1.80	2.80	15	<a href="#">RW27-1D2-D028</a>	\$40	
	2.80	4.00	15	<a href="#">RW27-1D2-U004</a>	\$40	
	4.00	6.30	25	<a href="#">RW27-1D2-D063</a>	\$40	
	5.60	8.00	30	<a href="#">RW27-1D2-U008</a>	\$50	
	7.00	10.0	40	<a href="#">RW27-1D2-U010</a>	\$50	
	8.00	12.5	50	<a href="#">RW27-1D2-D125</a>	\$50	
	10.0	15.0	60	<a href="#">RW27-1D2-U015</a>	\$50	
	11.0	17.0	60	<a href="#">RW27-1D2-U017</a>	\$50	
	15.0	23.0	90	<a href="#">RW27-1D2-U023</a>	\$50	
CWM32...CWM40	25.0	40.0	90	<a href="#">RW67-1D2-U040</a>	\$81	
	32.0	50.0	125	<a href="#">RW67-1D2-U050</a>	\$88	
CWM50...CWM80	25.0	40.0	90	<a href="#">RW67-2D2-U040</a>	\$95	
	32.0	50.0	125	<a href="#">RW67-2D2-U050</a>	\$95	
	40.0	57.0	150	<a href="#">RW67-2D2-U057</a>	\$95	
	50.0	63.0	150	<a href="#">RW67-2D2-U063</a>	\$95	
	57.0	70.0	175	<a href="#">RW67-2D2-U070</a>	\$105	
	63.0	80.0	175	<a href="#">RW67-2D2-U080</a>	\$105	

Note: 1 Availability upon request.

### For use with CWB Contactors

### Two-pole Thermal Overload Relays Class 10 (used for single phase applications)

- Adjustable tripping current
- Phase-loss sensitivity
- Tripping class 10
- Auxiliary contacts 1NO + 1NC
- Temperature compensation from -40F to +1400F
- Hand/Auto/Reset button

#### 2 POLE THERMAL OVERLOAD RELAYS - CLASS 10

Matching Contactor	Setting Range [A]		Max. Fuse [A]	Catalog Number	List Price	Multiplier
	Min.	Max.				
CWB9 - CWB38	0.28	0.40	15	<a href="#">RW27-2D2-D004</a>	\$50	Z2
	0.40	0.63	15	<a href="#">RW27-2D2-C063</a>	\$50	
	0.56	0.80	15	<a href="#">RW27-2D2-D008</a>	\$50	
	0.80	1.20	15	<a href="#">RW27-2D2-D012</a>	\$50	
	1.20	1.80	15	<a href="#">RW27-2D2-D018</a>	\$50	
	1.80	2.80	15	<a href="#">RW27-2D2-D028</a>	\$50	
	2.80	4	15	<a href="#">RW27-2D2-U004</a>	\$50	
	4	6.30	25	<a href="#">RW27-2D2-D063</a>	\$50	
	5.60	8.00	30	<a href="#">RW27-2D2-U008</a>	\$50	
	7.00	10.0	40	<a href="#">RW27-2D2-U010</a>	\$50	
	8.00	12.5	50	<a href="#">RW27-2D2-D125</a>	\$50	
	10.0	15.0	60	<a href="#">RW27-2D2-U015</a>	\$50	
	11.0	17.0	60	<a href="#">RW27-2D2-U017</a>	\$50	
	15.0	23.0	90	<a href="#">RW27-2D2-U023</a>	\$50	
	22.0	32.0	90	<a href="#">RW27-2D2-U032</a>	\$50	
32.0	40.0	90	<a href="#">RW27-2D2-U040</a>	\$50		

General Information

Circuit Protection

Disconnect Switches

Motor Protectors

Contactors

Overloads

Enclosed Starters

Relays

Pushbuttons and Pilot Lights

Terminal Blocks

Power Factor Correction

Appendix A

Appendix B

# Overloads

RW Series - Bi-Metallic

## Separate Mounting Bracket (not for use with RW27-2D)

General Information

Circuit Protection

Disconnect Switches

Motor Protectors

Contactors

Overloads

Enclosed Starters

Relays

Pushbuttons and Pilot Lights

Terminal Blocks

Power Factor Correction

Appendix A

Appendix B



Description	Mounting on Overload Relays (2 or 3 pole)	Catalog Number	List Price	Multiplier
Enables overload relay to be directly mounted to a back panel via screws or DIN rail	RW27-1D	<a href="#">BF27D</a>	\$14	Z2
	RW27-2D	<a href="#">BF27-2D</a>	\$14	
	RW67-1D and RW67-2D	<a href="#">BF67.1D</a>	\$23	
	RW117-1D	<a href="#">BF117D</a>	\$30	

## External Reset Button



Description	Mounting in Cover of Control Panel	Catalog Number	List Price	Multiplier
Enables overload relay to be Reset from control panel, without opening the cover	22 MM Flush Reset PB Blue 'R'	<a href="#">CSW-RSBF4R</a>	\$20	Z5
	30 MM Flush Reset PB Black 'Reset'	<a href="#">CSW30-RSBW</a>	\$22	

## Connector links (3 per package)



Description	Contactor	Overload Relay	Catalog Number	List Price	Multiplier
Link connectors for easier CWM contactors and RW overload relays assembly	CWM112	RW117-2D3	<a href="#">GA117D</a>	\$41	Z2
	CWM150	RW317-1D3	<a href="#">GA317-1D</a>	\$68	
	CWM180	RW317-1D3	<a href="#">GA317-2D</a>	\$70	
	CWM250 / CWM300	RW317-1D3	<a href="#">GA317-3D</a>	\$118	
	CWM400	RW317-1D3	<a href="#">GA317-10D</a>	\$118	

## Lugs for RW Series (Overload Relay) (3 units per package)

Description / Wire Range	Mounting on Overloads	Catalog Number	List Price	Multiplier
(2) 600 MCM...2AWG	RW407-2D (400A-840A)	<a href="#">LW1-2S600-B</a>	\$230	Z2
600 MCM...4AWG	RW317-1D (200A-420A)	<a href="#">LW2-S600</a>	\$75	
300 MCM...6AWG	RW317-1D (100A-215A)	<a href="#">LW3-S300</a>	\$35	

## Technical Data

## RW Series - Bi-Metallic

### General Data and Main Contacts

Catalog Number		RW17	RW27	RW67	RW117	RW317	RW407
Standards	Units	IEC 60947 / UL 508					
Setting current	(A)	0.28...17	0.28...32	25...80	75...112	100...420	400...840
Tripping class		10					
Temperature compensation		Continuous					
Rated insulation voltage Ui (pollution degree 3)	IEC 60947 (V) UL/CSA (V)	690			600		1,000
Rated impulse withstand voltage Uimp	(kV)	6					8
Rated operational frequency	(Hz)	0...400					
Degree of protection		IP 20					
Protection against direct contact from the front when actuated by a perpendicular test finger (IEC 536)		Finger and back-of-hand proof					
Ambient temperature		-25 oC to +60 oC					
Operating temperature		-40 oC to +70 oC					
Storage temperature							
Climating proof		Damp heat. constant					
IEC 60 068-2-3		Damp heat. constant					
IEC 60 068-2-30							
Current heat loss							
Lower value of setting range	(W)	0.9	0.9	1.5	2.3	1	
Higher value of setting range	(W)	1.4	1.7	4.7	4.7	1.9	

### Auxiliary Contacts

Models		RW17	RW27	RW67	RW117	RW317	RW407
Standards		IEC 60 947-4-1 and UL 508					
Rated insulation voltage Ui (pollution degree 3)	IEC (V) UL, CSA (V)	690			600		
Rated operational voltage Ue	IEC (V) UL, CSA (V)	690			600		
Rated thermal current Ith (θ ≤55 °C)	(A)	6					
<b>Rated operational current Ie</b>							
AC-14 / AC-15 (IEC 60947-5-1)	24 V (A)				4		
	60 V (A)				3.5		
	125 V (A)				3		
	230 V (A)				2		
	400 V (A)				1.5		
	500 V (A)				0.5		
UL, CSA	690 V (A)				0.3		
					C600		
	24 V (A)				1		
DC-13 / DC-14 (IEC 60947-5-1)	60 V (A)				0.5		
	110 V (A)				0.25		
	220 V (A)				0.1		
					R300		
Short-circuit protection with fuse (gL/gG)	(A)	6					
Minimum voltage / admissible current (IEC 60947-5-4)		17 V / 5 mA					

### Terminal Capacity and Tightening Torque - Main Contacts

Reference		RW17	RW27	RW67	RW117	RW317	RW407
Current setting	(A)	0.28...17	0.28...32	25...80	75...112	100...215 / 200...420	400...840
<b>Cable size (75 °C / Cu cable)</b>							
Flexible cable	1 cable (mm <sup>2</sup> )	1,5...10		6,0...35	25...35	35...120	95...150
	2 cables (mm <sup>2</sup> )			-	-		-
Cable with terminal or rigid cable	1 cable (mm <sup>2</sup> )	1,5...6,0		6,0...35	25...35	35...120	95...150
	2 cables (mm <sup>2</sup> )			-	-		-
Busbar	(mm <sup>2</sup> )					Max 2x (25x5)	Max 2x (60x10)
Tightening torque	(N.m)	2,3		4,0	6,0	16,0	26,0
UL cable size (75 °C - Cu cable)	AWG	16...8		10...3	6...1/0	3-300 kc- mil	3/0 - 600 kcmil
Tightening torque (UL)	(lb.in)	20		35	53	141	230

### Terminal Capacity and Tightening Torque - Auxiliary Contacts

Models		RW17	RW27	RW67	RW117	RW317	RW407
Type of screws		M3.5 x 10 Philips					
Cable size (75 °C / Cu cable)							
Cable with or without terminal	(mm <sup>2</sup> )			2 x 1...2.5			
AWG-wire				16...12			
Tightening torque	(N.m / lb.in)			1.5 / 13			

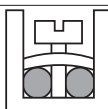

# Overloads

## RW Series - Bi-Metallic

### Technical Data

#### Main Data

Models	RW27	
Standards	IEC 60947-1 and UL 508	
Rated insulation voltage $U_i$ (pollution degree 3)	IEC 60947-4-1 (V)	690
	UL, CSA (V)	600
Rated impulse withstand voltage $U_{imp}$ (IEC 60947-1)	(kV)	6
Rated operational frequency	(Hz)	25...400
Use with direct current		Yes
Maximum operation per hour	(ops./h)	15
Protection degree (IEC 60529)	Main contacts	IP10
	Auxiliary contacts	IP20
	Frontal	IP20
Mounting	Direct on the contactor	
Resistance to impact (IEC 60068-2-27 - 1/2 sinusoid)	(g/ms)	10/11
Ambient temperature	Transport and storage	-50 °C...+80 °C
	Operating	-20 °C...+70 °C
	Temperature compensation	-20 °C...+60 °C
Altitude	(m)	2000

#### Main Contacts

Models	RW27	
Rated operational voltage $U_e$	IEC 60947-4-1 (V)	690
	UL, CSA (V)	600
Setting current / max fuse (gL/gG)1 (A)		0.28...0.4 / 2
		0.43...0.63 / 2
		0.56...0.8 / 2
		0.8...1.2 / 4
		1.2...1.8 / 6
		1.8...2.8 / 6
		2.8...4 / 10
		4...6.3 / 16
		5.6... 8 / 20
		7...10 / 25
		8...12.5 / 25
		10...15 / 35
		11...17 / 40
		15...23 / 50
	22...32 / 63	
	32...40 / 90	
Average power dissipation per pole	(W)	≤3

General Information

Circuit Protection

Disconnect Switches

Motor Protectors

Contactors

Overloads

Enclosed Starters

Relays

Pushbuttons and Pilot Lights

Terminal Blocks

Power Factor Correction

Appendix A

Appendix B

### RW Tripping Characteristics

These tripping characteristics show the tripping of RW in relation to the current. They show the mean values of the tolerance ranges at an ambient temperature of 68°F (20°C), starting from cold stats. The tripping time of the overload releases at operational temperature is reduced to approximately 25% of the values shown. Under normal operational conditions, all three phases of the RWs should be loaded.

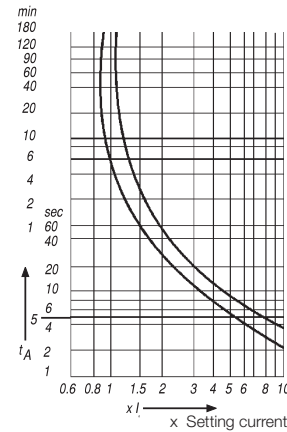

### Altitude & Temperature Derating

The derating of a RW overload relay has two possible factors:

- 1) Ambient temperature
  - Temperature compensation considers a factor according to which the rated current must be reduced when ambient temperature is higher than 60°C (140°F).
- 2) Altitude
  - Altitude compensation involves both, rated current and voltage.
  - Current compensation considers a factor according to the rated current must be reduced.
  - For voltage, altitude limits the higher operating voltage the overload relay can be used.

Temperature Compensation		Current Correction factor
149°F	(65°C)	0.94
158°F	(70°C)	0.87
167°F	(75°C)	0.81
176°F	(80°C)	0.73

Altitude	Voltage Correction [Ue]
Up to 2,000m (6,667ft)	690
Up to 3,000m (10,000ft)	550
Up to 4,000m (13,333ft)	480
Up to 5,000m (16,667ft)	420

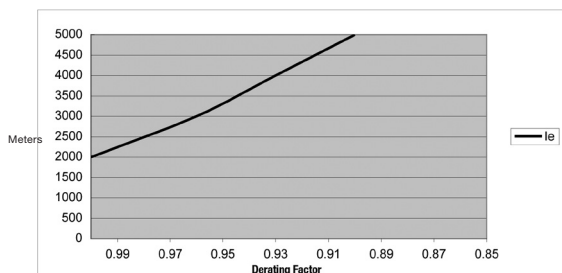

The derating of the permissible operating current for installation altitudes above 2,000m (6,667 ft) and ambient temperatures over 60°C (140°F) is calculated according to:

Total derating = Derating altitude x Derating ambient temperature

Example;  
 Altitude: 3,000 m (10,000 ft)  
 $K1 = 0.96$   
 Ambient temperature: 70°C (158°F)  
 $K2 = 0.87$

Total current derating =  $0.96 \times 0.87 = 0.84 \times I_e$   
 In this case, the maximum rated voltage we can connect to our RW overload relay is 550V.

In order to select the proper overload relay, you have to choose a device with a current range that accommodates:  
 Overload Setting Point =  $FLA \text{ motor} / (K1 \times K2)$

As in the example above,  $K1 \times K2 = 0.84$   
 For a motor with  $FLA = 20\text{Amps}$

Overload Setting Point =  $20 / 0.84 = 23.8\text{Amps}$

# Overloads

## RW Series - Bi-Metallic

### Operating Positions<sup>1</sup>

#### RW17D, RW27D, RW67D, RW117D, RW317D, RW407D

Mounting without contactor

The overload relays can be mounted at any position.

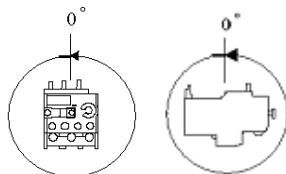

#### RW17D with CWC Series

As showed at the left figure below, the inclination can not exceed  $\pm 30^\circ$  degrees for a perfectly functioning of the contactor. Laterally, as showed at the right figure below, the mounting position is equivalent to  $0^\circ$  degrees - not requiring a correction factor on the dial of the relay. The assembly can work with mounting variations of  $0^\circ$  to  $180^\circ$

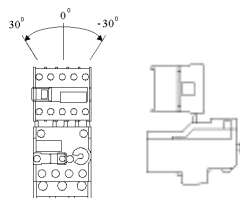

#### RW27D, RW67D, RW117D, RW317D, RW407

The mounting position showed at the left figure below is equivalent to  $0^\circ$  degrees - not requiring a correction factor on the dial of the relay. The assembly can work with mounting variations of  $0^\circ$  to  $135^\circ$  for each side, however the mounting with the relay above the contactor, position between  $135^\circ$  and  $225^\circ$ , is required a correction factor of +10% on the dial of the relay. Laterally, as showed at the right figure below, the inclination can not exceed  $\pm 30^\circ$  for a perfect functioning of the contactor. [D with CWM/CWM Series](#)

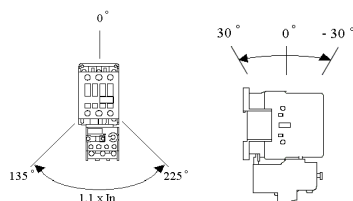

Note: 1)Please consult WEG for different mounting positions.

General Information

Circuit Protection

Disconnect Switches

Motor Protectors

Contactors

Overloads

Enclosed Starters

Relays

Pushbuttons and Pilot Lights

Terminal Blocks

Power Factor Correction

Appendix A

Appendix B

**RW17-1D**

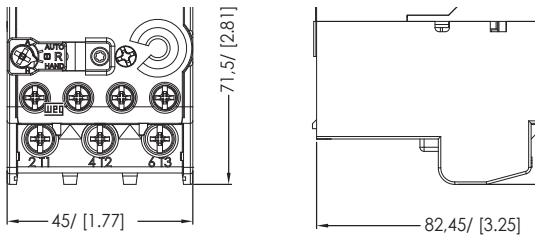

**RW17-2D**

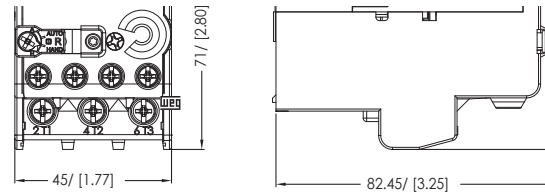

**RW27**

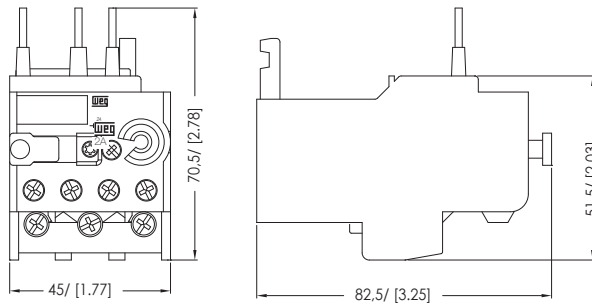

**RW27 + BF27**

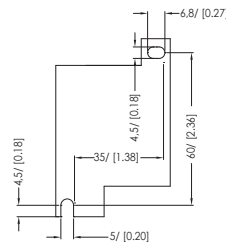
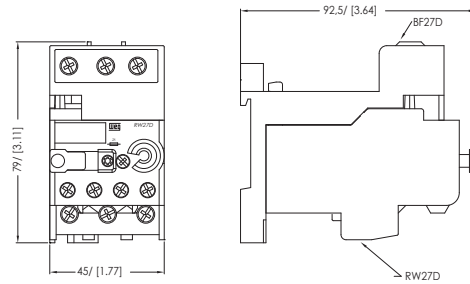

**RW67**

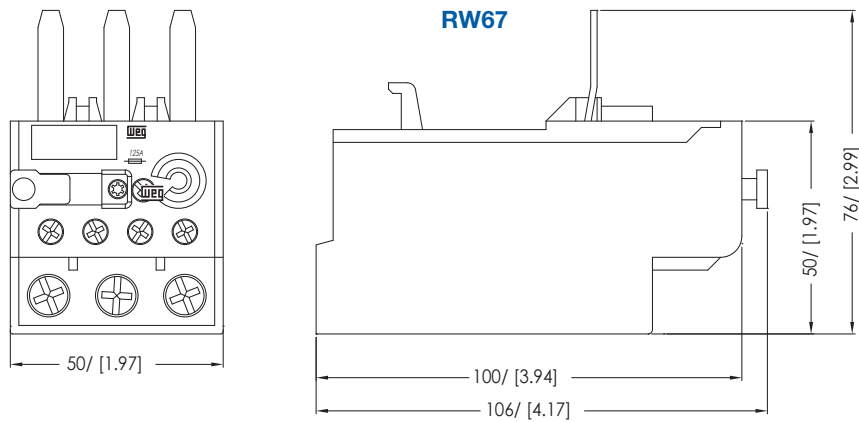

General Information

Circuit Protection

Disconnect Switches

Motor Protectors

Contactors

Overloads

Enclosed Starters

Relays

Pushbuttons and Pilot Lights

Terminal Blocks

Power Factor Correction

Appendix A

Appendix B

## RW Series - Bi-Metallic

General Information

Circuit Protection

Disconnect Switches

Motor Protectors

Contactors

Overloads

Enclosed Starters

Relays

Pushbuttons and Pilot Lights

Terminal Blocks

Power Factor Correction

Appendix A

Appendix B

### RW67 + BF67

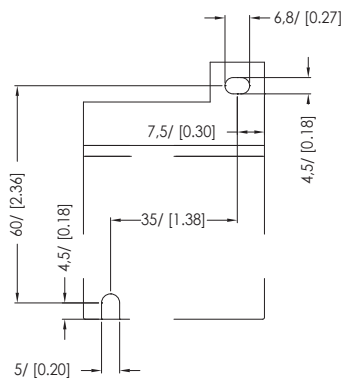
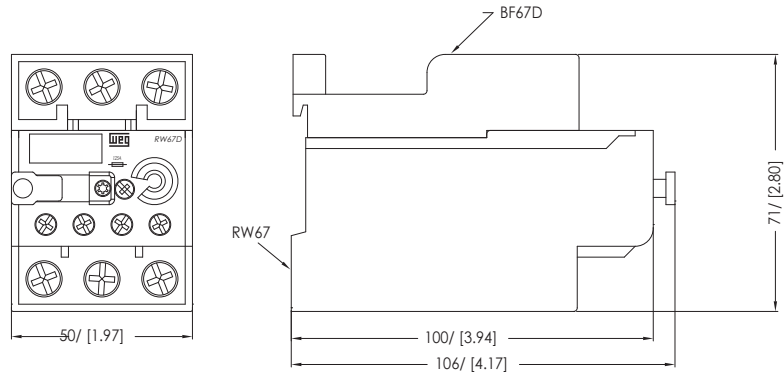

### RW117-1D

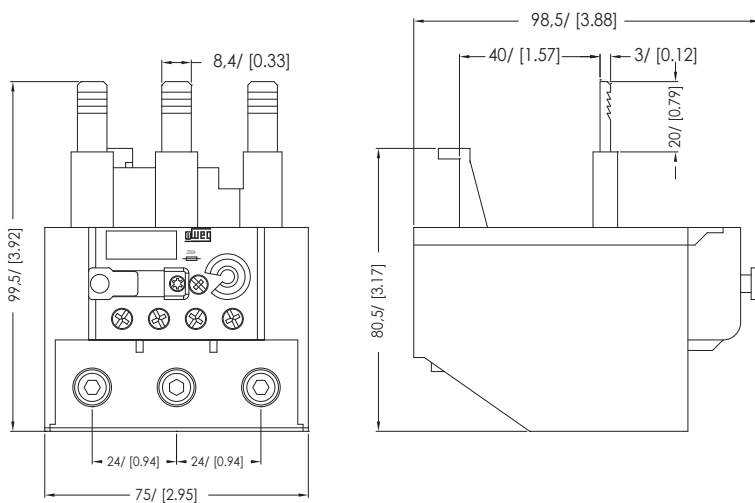

### RW117-2D

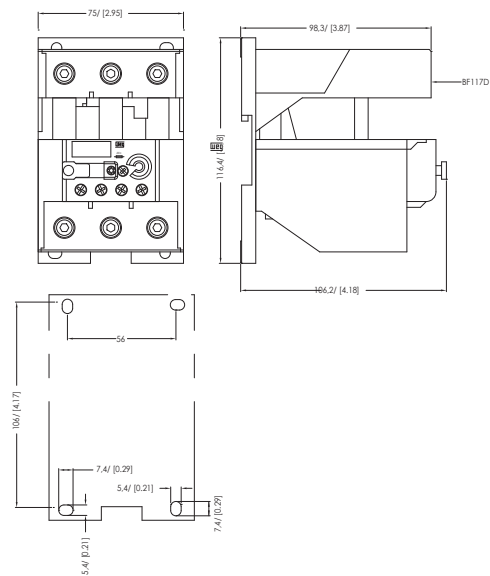

### RW317

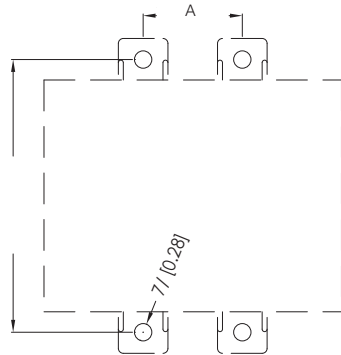
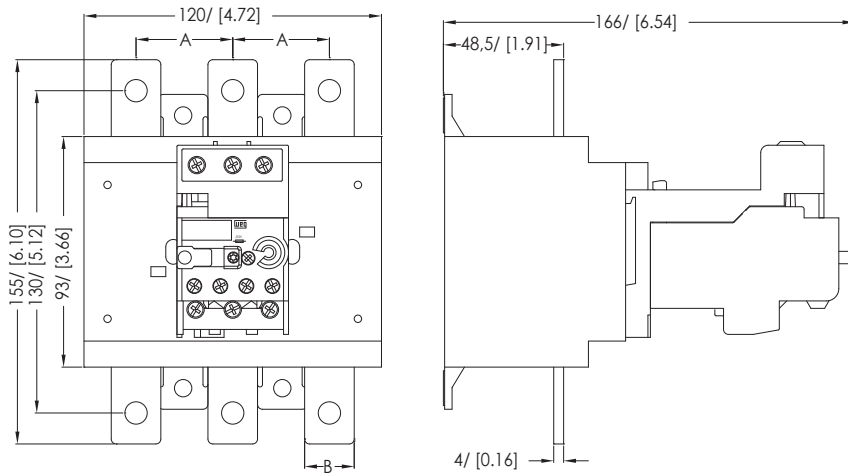

Current ranges	A	B
100...150A	39(1.5)	20(0.8)
140...215A		
200...310A	45(1.8)	25(1.0)
275...420A		

### RW407

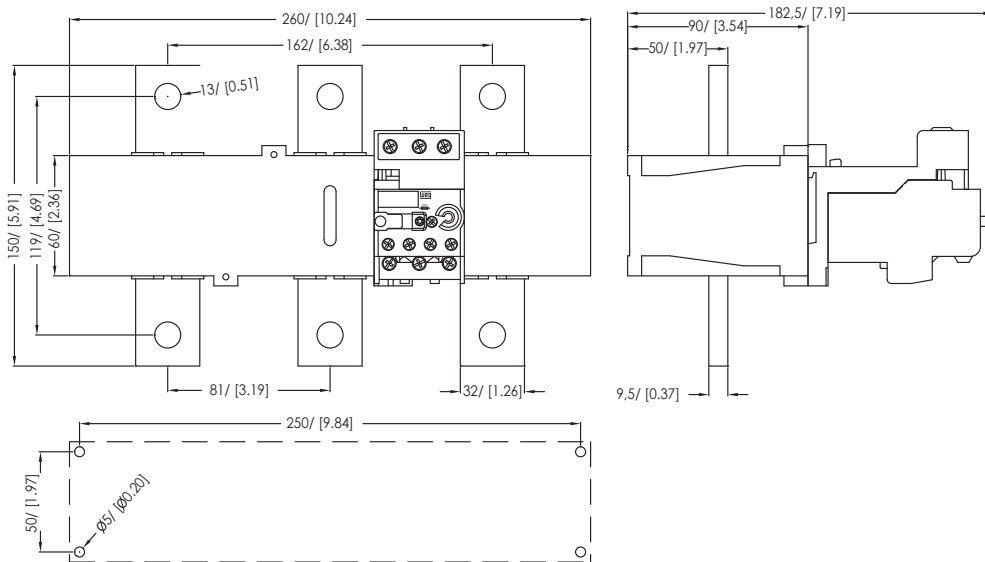

General Information

Circuit Protection

Disconnect Switches

Motor Protectors

Contactors

Overloads

Enclosed Starters

Relays

Pushbuttons and Pilot Lights

Terminal Blocks

Power Factor Correction

Appendix A

Appendix B