

## Yaskawa AC Drive Option Bluetooth LCD Keypad Installation Manual

Type: JVOP-KPLCC04Axx, JVOP-KPLCC04Mxx

To properly use the product, read this manual thoroughly and retain for easy reference, inspection, and maintenance. Ensure the end user receives this manual.



---

**This Page Intentionally Blank**

# Table of Contents

---

1.	Preface and Safety . . . . .	6
	Applicable Documentation . . . . .	6
	Glossary . . . . .	6
	Registered Trademarks . . . . .	7
	Supplemental Safety Information . . . . .	7
	Use Precautions . . . . .	8
2.	Overview . . . . .	8
3.	Receiving . . . . .	10
4.	Component Names and Functions . . . . .	11
	Indicator LEDs and Drive Status . . . . .	15
5.	Installation and Primary Operation . . . . .	17
	Section Safety . . . . .	17
	Installing the Keypad on the Drive . . . . .	17
	Connecting the Keypad and Smart Device . . . . .	18
	Prepare the Information Necessary for Connection . . . . .	18
	Install DriveWizard Mobile . . . . .	19
	Enabling Bluetooth Communications . . . . .	20
	Connect to the Drive . . . . .	23
	Disconnect Bluetooth Communications . . . . .	30
	Bluetooth Mode . . . . .	31

Bluetooth Mode and Normal Operation Mode . . . . .	32
Key Functions in Bluetooth Mode . . . . .	33
Bluetooth Mode Screen Displays . . . . .	34
Connecting the Keypad and Smart Device (REV: C or Earlier) . . . . .	35
Prepare the Information Necessary for Connection (REV: C or Earlier) . . . . .	35
Install DriveWizard Mobile (REV: C or Earlier) . . . . .	35
Connect to the Drive (REV: C or Earlier) . . . . .	36
Disconnect Bluetooth Communications (REV: C or Earlier) . . . . .	44
Bluetooth Mode (REV: C or Earlier) . . . . .	46
Bluetooth Mode and Normal Operation Mode (REV: C or Earlier) . . . . .	46
Key Functions in Bluetooth Mode (REV: C or Earlier) . . . . .	47
Bluetooth Mode Screen Displays (REV: C or Earlier) . . . . .	48
Remote Keypad Installation Methods . . . . .	49
External Dimensions of Keypad . . . . .	51
Procedure A . . . . .	52
Procedure B . . . . .	61
Replace the Keypad Battery . . . . .	71
6. Related Parameters . . . . .	75
7. Fault Diagnostics and Solutions . . . . .	76
8. Standards Compliance . . . . .	77
European Standards (RE Directives) . . . . .	77
FCC and IC Certifications . . . . .	78
CMIIT Certification . . . . .	79
Japan Radio Law . . . . .	79
9. Disposal Instructions . . . . .	79
WEEE Directive . . . . .	80
10. Specification . . . . .	80

---

11. Warranty	82
Warranty Period	82
Post-Warranty Repair Period	82
Cyber Security Disclaimers	83
About Application of This Product	83
Revision History	84

## 1 Preface and Safety

### ◆ Applicable Documentation

Document	Description
Yaskawa AC Drive Option Bluetooth LCD Keypad Installation Manual	<p>Read this manual before you install this option to the drive.</p> <p>The manual contains basic information about how to install, wire, and connect and disconnect smartphones or tablets through Bluetooth communication.</p> <p>This manual is in the product package.</p>
Yaskawa AC Drive Manuals	<p>For information about drive settings, refer to the manuals for the drive on which you will use this kit.</p> <p>The manuals provide information about basic installation, wiring, operation procedures, functions, troubleshooting, and maintenance.</p> <p>The manuals also include important information about parameter settings and tuning the drive.</p> <p>You can download drive manuals from the Yaskawa product and technical information website shown on the back cover of this manual.</p>

#### Note:

This manual shows typical examples. Different drive models can have different functions. Refer to the drive manuals for more information.

### ◆ Glossary

Phrase	Definition
Drive	<ul style="list-style-type: none"> <li>• YASKAWA AC Drive GA500</li> <li>• YASKAWA AC Drive GA700</li> <li>• YASKAWA AC Drive GA800</li> <li>• YASKAWA AC Drive CH700</li> <li>• YASKAWA AC Drive CR700</li> </ul>
Keypad Bluetooth Keypad	Yaskawa AC Drive Option Bluetooth LCD Keypad

Phrase	Definition
Standard Keypad	LCD keypad without Bluetooth capability
Bluetooth Mode	A mode where the Bluetooth Keypad broadcasts Bluetooth. A smart device using the DriveWizard Mobile App can communicate with the drive through Bluetooth.
Normal Operation Mode	A mode where the Bluetooth Keypad does not broadcast Bluetooth. The Bluetooth Keypad can be used as the Standard Keypad.
DriveWizard Mobile	A mobile app for Android and iOS that simplifies drive parameter management and monitoring.

### ◆ Registered Trademarks

- Bluetooth® is a trademark or registered trademark of Bluetooth SIG, Inc. USA.
- Google Play and the Google Play logo are trademarks of Google LLC.
- Apple and the Apple logo are trademarks of Apple Inc., registered in the U.S. and other countries.
- App Store is a service mark of Apple Inc.
- The iOS trademark is used under license of Cisco in the U.S.
- QR Code is a registered trademark of DENSO WAVE INCORPORATED.
- Other company names and product names in this manual are trademarks or registered trademarks of the respective companies.

### ◆ Supplemental Safety Information

Read and understand this manual before you install, operate, or do maintenance on the option. Use this option as specified by this manual and local codes.

The symbol marks in this section identify safety messages in this manual. If you do not obey these safety messages, the hazards can cause serious injury, death, or damage to the products and related equipment and systems.

**⚠ DANGER** *This signal word identifies a hazard that will cause serious injury or death if you do not prevent it.*

**⚠ WARNING** *This signal word identifies a hazard that can cause death or serious injuries if you do not prevent it.*

**⚠ CAUTION** *Identifies a hazardous situation, which, if not avoided, can cause minor or moderate injury.*

**NOTICE** *This signal word identifies a property damage message that is not related to personal injury.*

### ■ General Safety

#### General Precautions

- The figures in this manual can possibly include options and drives without covers or safety shields to show detail. Install missing covers or safety shields before you operate the drive. Use the option only as specified by the instructions in this manual.
- The diagrams in this manual are only examples and are not always related to all the products included in this manual.
- Yaskawa can change the products and specifications in this manual or the content and presentation of the manual without notice to improve the product and/or the manual.
- If you damage or lose manuals, contact a Yaskawa representative or the nearest Yaskawa sales office shown on the rear cover of the manual, and tell them the document number on the front cover to order new copies.

**⚠ DANGER** *Do not ignore the safety messages in this manual. If you ignore the safety messages in this manual, it will cause serious injury or death. The manufacturer is not responsible for injuries or damage to equipment.*

---

### ◆ Use Precautions

This product includes a wireless device. Some countries restrict the use of wireless devices as specified by their radio laws. Confirm the radio laws of the country in which you will use the device.

## 2 Overview

Use a Bluetooth Keypad and the DriveWizard Mobile App to use Bluetooth to communicate with the drive. The Bluetooth keypad

has all of the functions of the standard keypad plus Bluetooth connectivity.

Key features of this keypad include the ability to:

- Read and modify drive parameter settings
- Back up, restore, and verify drive parameters
- Monitor drive operation status

## ◆ Compatible Products

Drive	Drive Software Version <sup>*1</sup>
GA500	All
GA700	1016 or later
GA800	All
CH700	All
CR700	All

\*1 Refer to "PRG" on the drive nameplate for the software version number.

## 3 Receiving

1. Make sure that there is no damage to the keypad and no parts are missing.  
If there is damage to the products, contact the shipping company immediately. The Yaskawa warranty does not include damage from shipping.
2. Make sure that the model number on the option nameplate and the model number on the purchase order are the same.  
If you have problems with the option, contact the distributor where you purchased the option or the Yaskawa sales office immediately.

### ◆ Option Package Contents

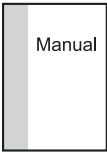
Option Contents		Quantity
Bluetooth LCD Keypad		1
Installation Manual (This document)		1

## 4 Component Names and Functions

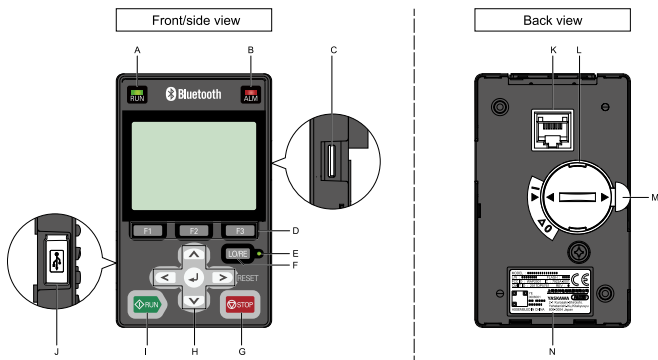

















Figure 4.1 Keypad

Table 4.1 Component Names and Functions

-	Name	Functions
A	RUN LED 	Illuminates while the drive is operating the motor.
B	ALM LED 	Illuminates when the drive detects a fault.
C	microSD Card Slot	The slot for a microSD card.

## 4 Component Names and Functions

-	Name	Functions
D	Function Keys F1, F2, F3 	The menu shown on the keypad sets the functions for function keys. The name of each function is directly above each key in the LCD display window.
E	LO/RE LED 	Illuminates when you select the keypad for Run command and frequency reference control (LOCAL).
F	LO/RE Selection Key 	Switches drive control for the Run command and frequency reference between the keypad (LOCAL) and an external source (REMOTE). <b>Note:</b> <ul style="list-style-type: none"> <li>The drive will not switch between LOCAL and REMOTE when it is receiving a Run command from an external source.</li> <li>When you stop the drive in Drive Mode, the LOCAL/ REMOTE Selection Key stays enabled. If the application must not switch from REMOTE to LOCAL because it will have a negative effect on system performance, set <math>o2-01 = 0</math> [<i>LO/RE Key Function Selection = Disabled</i>] to disable .</li> </ul>
G	STOP Key 	Stops drive operation. <b>Note:</b> Push  to stop the motor. This will also stop the motor when a Run command is active at an external Run command source (REMOTE Mode). To disable  priority, set $o2-02 = 0$ [ <i>STOP Key Function Selection = Disabled</i> ].



-	Name	Functions
H	Left Arrow Key 	Moves the cursor to the left.
	Up Arrow Key/Down Arrow Key  / 	<ul style="list-style-type: none"> <li>• Scrolls up or down to show the next item or the previous item.</li> <li>• Selects parameter numbers, and increments or decrements setting values.</li> </ul>
	Right Arrow Key (RESET) 	<ul style="list-style-type: none"> <li>• Moves the cursor to the right.</li> <li>• Continues to the next screen.</li> <li>• Clears drive faults.</li> </ul>
	ENTER Key 	<ul style="list-style-type: none"> <li>• Enters parameter values and settings.</li> <li>• Selects menu items to move the user between keypad displays.</li> <li>• Selects each mode, parameter, and set value.</li> </ul>
I	RUN Key 	Starts the drive in LOCAL Mode. Starts the motor tuning procedure in Auto-Tuning Mode. <b>Note:</b> Before you use the keypad to operate the motor, push  on the keypad to set the drive to LOCAL Mode.
J	USB Terminal	Factory use for maintenance.
K	RJ-45 Connector	Connects to the drive using an RJ-45 8-pin straight through UTP CAT5e extension cable or keypad connector.
L	Clock Battery Cover	Cover for the clock battery.



## 4 Component Names and Functions

-	Name	Functions
M	Insulation Sheet	Remove the insulation sheet before you use the clock function. <b>Note:</b> An insulating sheet is attached to the keypad with built-in battery.
N	Nameplate	Shows the model number of the keypad and other information <b>Note:</b> <ul style="list-style-type: none"><li>• “REV” identifies the hardware and software version of the keypad.</li><li>• “FCC ID” is the ID issued by the U.S. Federal Communications Commission.</li><li>• “IC” is the Canadian authentication code.</li></ul>

**⚠ WARNING** *Sudden Movement Hazard. If you change the control source when b1-07 = 1 [LOCAL/REMOTE Run Selection = Accept Existing RUN Command], the drive can start suddenly. Before you change the control source, remove all personnel from the area around the drive, motor, and load. Sudden starts can cause serious injury or death.*

## ◆ Indicator LEDs and Drive Status

LED	Display	Drive Status
RUN LED 	Illuminated	The drive is operating the motor.
	Flashing	<ul style="list-style-type: none"> <li>The drive is decelerating to stop.</li> <li>The drive received a Run command with a frequency reference of 0 Hz, but the drive is not set for zero speed control.</li> <li>The drive received a DC Injection Braking command.</li> </ul>
	Flashing Quickly	<ul style="list-style-type: none"> <li>The drive received a Run command from the MFDI terminals and is switching to REMOTE Mode while the drive is in LOCAL Mode.</li> <li>The drive received a Run command from an external source and the drive is not in Drive Ready (READY) condition.</li> <li>The drive received a Fast Stop command.</li> <li>The safety function shut off the drive output.</li> <li>You pushed  on the keypad while the drive is operating in REMOTE Mode.</li> <li>The drive is energized with an active Run command and <math>b1-17 = 0</math> [Run Command at Power Up = Disregard Existing RUN Command].</li> <li>When <math>b1-03 = 3</math> [Stopping Method Selection = Coast to Stop with Timer], the Run command is disabled then enabled during the Run wait time.</li> <li>The drive received a DC Injection Braking command.</li> <li>The voltage of the main circuit power supply decreased, and the 24 V power supply is supplying power only the the drive.</li> </ul>
	OFF	The motor is stopped.

LED	Display	Drive Status
ALM LED 	Illuminated	The drive detects a fault.
	Flashing	The drive detected one of the following: <ul style="list-style-type: none"> <li>• An alarm</li> <li>• An oPE parameter setting error</li> <li>• A fault or error during Auto-Tuning</li> </ul> <b>Note:</b> The digital characters displayed on the keypad will also flash.
	OFF	There are no drive faults or alarms.
LO/RE LED 	Illuminated	The keypad controls the Run command (LOCAL Mode).
	OFF	The control circuit terminal or serial transmission device controls the Run command (REMOTE Mode).

### ■ LED Flashing Statuses

Refer to [Figure 4.2](#) for information about the differences between flashing and “flashing quickly”.

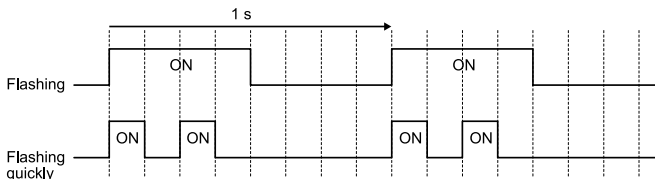

**Figure 4.2 LED Flashing Statuses**

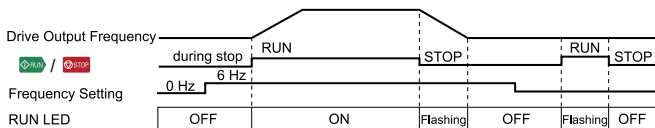

**Figure 4.3 Relation between RUN indicator and Drive Operation**

## 5 Installation and Primary Operation

### ◆ Section Safety

**NOTICE** *Damage to Equipment. Correctly connect all pins and connectors. If the pins and connectors are incorrect, it can cause damage to equipment and incorrect operation.*

**NOTICE** *Damage to Equipment. Do not bend the communication cables more than the bend radius specifications. If you bend the cables too much, it can break the wires and loosen connections.*

**Note:**

Use Yaskawa connection cables or recommended cables only. Incorrect cables can cause the drive or option to function incorrectly.

### ◆ Installing the Keypad on the Drive

Refer to *Remote Keypad Installation Methods on page 49* when you install the keypad on an enclosure panel.

1. Remove the standard keypad that shipped with the drive.

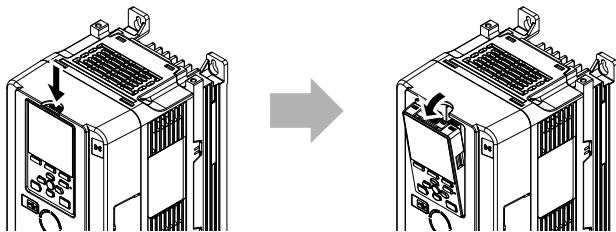

**Figure 5.1 Remove the Keypad**

2. Put the bottom of the Bluetooth keypad into position first, then carefully push on the top of the keypad until the hook clicks into place.

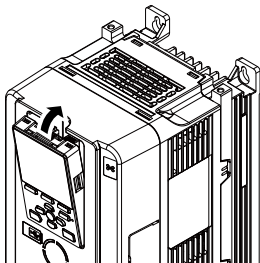

**Figure 5.2 Attach the Keypad**

---

### ◆ Connecting the Keypad and Smart Device

The procedure to connect the keypad and smart device is different for different keypad versions. When you have a REV: C or earlier keypad, refer to *Connecting the Keypad and Smart Device (REV: C or Earlier)* on page 35. Refer to “REV” on the keypad nameplate for the keypad version.

### ■ Prepare the Information Necessary for Connection

Collect this information before you connect the keypad to a smartphone or tablet with Bluetooth communications:

1. Yaskawa Drive Cloud account Member ID and Password.

**Note:**

- Access the URL on the back cover of this manual to register for an account.
- For Japan: Member ID and password to the Yaskawa product and technical information website

2. Setting value of *A1-12 [Bluetooth ID]*

**Note:**

When *A1-12 = 0000*, Bluetooth communication is disabled. Set the Bluetooth ID  $\neq 0000$  to enable Bluetooth. Refer to *Enabling Bluetooth Communications on page 20* for more information.

3. Drive series and serial number of the drive to which you will connect

**Note:**

- To retrieve the Device Name transmitted by Bluetooth, push **F2** (Device Name).

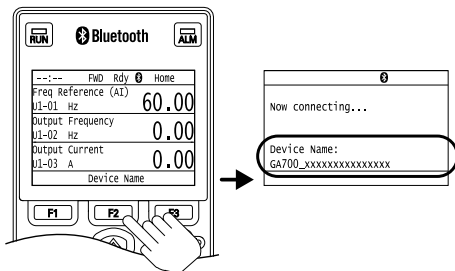
**Figure 5.3 Device Name**



- Use the Device Name when you connect a smartphone or tablet to the drive to identify your drive from the other devices that are transmitting Bluetooth.

## ■ Install DriveWizard Mobile

Download DriveWizard Mobile to your smartphone or tablet through the Apple App Store or Google Play Store.

- For Android devices: Google Play Store
- For iOS devices: App Store

**Table 5.1 QR Codes**

Google Play Store	App Store
	

Refer to [Table 5.2](#) for operating systems and drives compatible with the DriveWizard Mobile App.

**Table 5.2 DriveWizard Mobile Specifications**

Item	Description
Compatible Drive Series	<ul style="list-style-type: none"> <li>• YASKAWA AC Drive GA500</li> <li>• YASKAWA AC Drive GA700</li> <li>• YASKAWA AC Drive GA800</li> <li>• YASKAWA AC Drive CH700</li> <li>• YASKAWA AC Drive CR700</li> </ul>
Recommended Operating Environment for Smart Device	<ul style="list-style-type: none"> <li>• OS: Android 6.0, 7.0, 7.1, 8.0, 8.1 or iOS 10, 11, 12</li> <li>• Support for Bluetooth 4.0 or 4.1</li> </ul>

## ■ Enabling Bluetooth Communications

1. Push **F2** two times on the initial Setup screen.

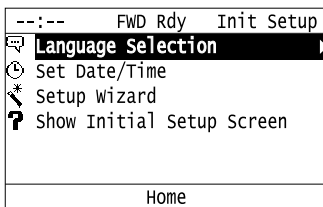

2. Push  to select [Parameters] then push .

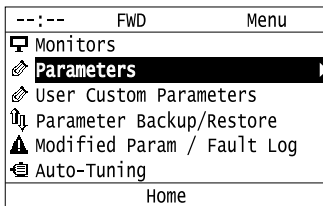

3. Select [A Initialization Parameters] then push .

--:--	FWD	Parameters
<b>A</b>	<b>Initialization Parameters</b>	▶
b	Application	
C	Tuning	
d	References	
E	Motor Parameters	
F	Options	
	Back	Home

4. Select [A1 Initialization] then push .

--:--	FWD	Parameters
<b>A1</b>	<b>Initialization</b>	▶
A2	User Parameters	
	Back	Home

5. Select [Bluetooth ID] then push .

--:--	FWD	Parameters
Application Preset		
A1-06	1	(0)
DriveworkSEZ Function Selection		
A1-07	0	(0)
<b>Bluetooth ID</b>		
<b>A1-12</b>	<b>0</b>	
	Back	Home

6. Set A1-12  $\neq$  0000 [Bluetooth ID  $\neq$  0000].

--:--	FWD	Parameters
Bluetooth ID		
A1-12		0000
Default :		
Range :		0~9999
Back	Default	Min/Max



--:--	FWD	Parameters
Bluetooth ID		
A1-12		1235
Default :		
Range :		0~9999
Back	Default	Min/Max

7. Push  [ENTER key] to keep the new A1-12 setting.

--:--	FWD	Parameters
Application Preset		
A1-06	1	(0)
DriveworksEZ Function Selection		
A1-07	0	(0)
<b>Bluetooth ID</b>		
<b>A1-12</b>		<b>1235</b>
Back	Home	

8. Push and hold  (Home) to show the HOME screen in Bluetooth Mode.

--:--	FWD	Rdy		Home
Freq Reference (AI)				
U1-01 Hz				60.00
Output Frequency				
U1-02 Hz				0.00
Output Current				
U1-03 A				0.00
Device Name				

**Note:**

- The Bluetooth icon shows that the Bluetooth is enabled.
- You can temporarily disable Bluetooth and change to Normal Operation Mode when you push a key other than .
- When the keypad is idle for longer than 60 seconds, the keypad will automatically go back to Bluetooth Mode, even after you change to Normal Operation Mode.

## ■ Connect to the Drive

Use this procedure to launch DriveWizard Mobile and connect to the drive.

1. Start DriveWizard Mobile on your smartphone or tablet.



2. Tap [Log In] to Log into DriveWizard Mobile. Use your Drive Cloud ID and password.

If you do not have an account, tap [New Member Registration]

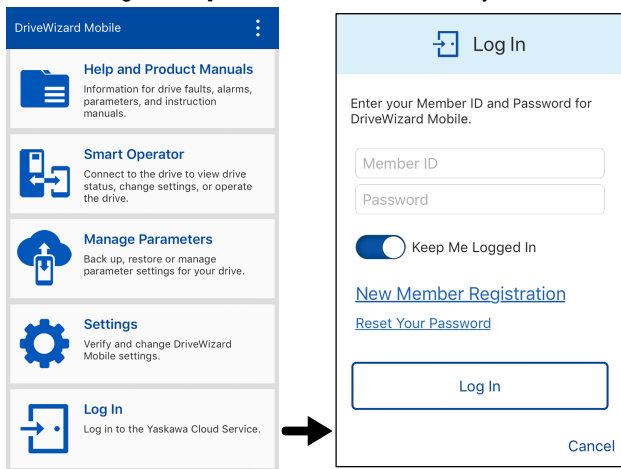

3. Tap [Help and Product Manuals] on the Home Screen, select the drive model to connect, and download the product information.

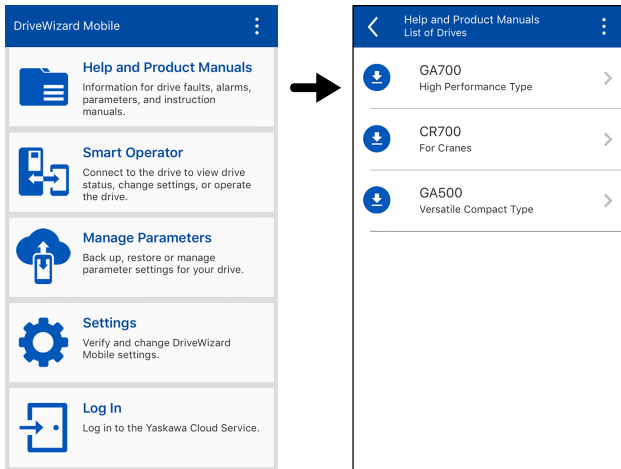

## 4. Tap [Smart Operator].



## 5. Select [Bluetooth] then tap [Connect].

**Note:**

This dialog screen is only for Android smart devices. Skip this step for iOS devices.

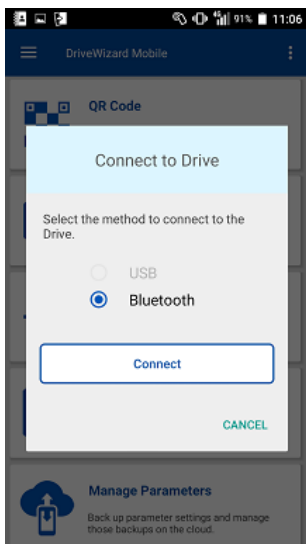

6. Tap the correct drive in the list of Bluetooth devices to make the connection.

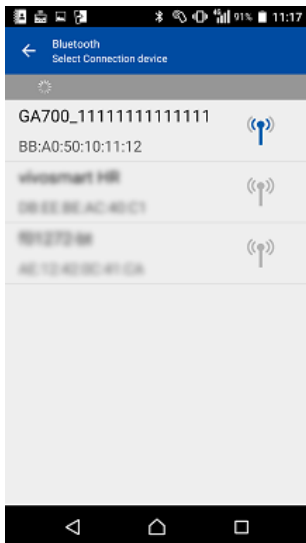

**Note:**

- Push **F2** (Device Name) to check the Device Name of the drive you will connect.
- The device name of the drive is shown as "Drive Series\_Serial Number". If necessary, use the [Drive Information] menu in DriveWizard Mobile to change the "Serial Number" to a different value.
- If you did not download the product information of the connected drive, download the product information as specified by the dialog.

7. Make sure that the screen shows the correct drive information and tap [YES].

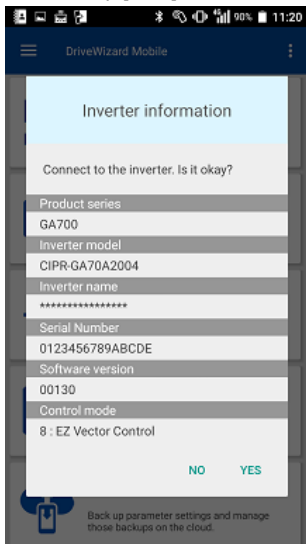

**Note:**

Make sure that the LED status ring of the connected drive is flashing. When you install the Bluetooth keypad on a GA500 drive, the drive will not have an LED status ring.

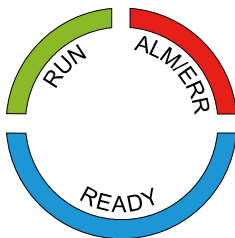

**Figure 5.4 LED Status Ring**

8. Enter the setting value of A1-12 [Bluetooth ID] on the Bluetooth ID Input screen and tap [OK].

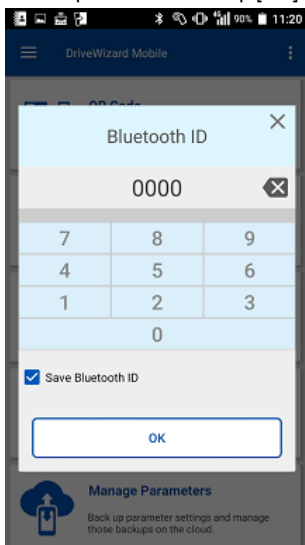

**Note:**

Check the [Save Bluetooth ID] checkbox to skip this step in the future.

When you connect the drive and your smartphone or tablet, the smart device will show the list of U1: [Operation Status Monitors].

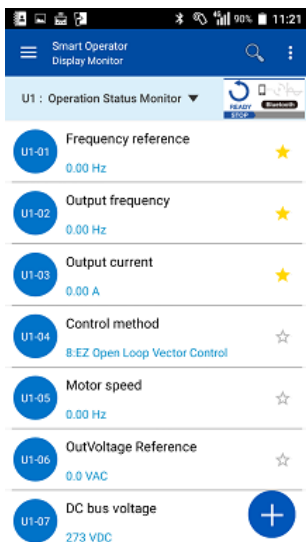

Bluetooth connection procedure is complete.



**Note:**

Refer to the DriveWizard Mobile Help for more information about how to use DriveWizard Mobile to operate the drive.

### ■ Disconnect Bluetooth Communications

The operation to disconnect Bluetooth communications is different for different operating devices. [Table 5.3](#) lists the disconnection methods for each operating device.

Table 5.3 Operating Devices and Disconnection Method

Operating Device	Disconnection Method
Smartphone or Tablet	Go back to the DriveWizard Mobile App Home screen to disconnect communications with the keypad.
Keypad	<ul style="list-style-type: none"> <li>• Push  to stop communications between the smartphone or tablet and the drive and switch the keypad to Normal Operation Mode.</li> <li>• Push a key other than  to show the confirmation screen before you disconnect from the smartphone or tablet. Select [Yes, disconnect.] to disconnect and switch to Normal Operation Mode.</li> </ul> <div data-bbox="441 550 864 812" style="border: 1px solid black; padding: 10px; margin: 10px 0;"> <p style="text-align: center;">Disconnect Bluetooth mode?</p> <p style="text-align: center;"><b>No, continue.</b></p> <p style="text-align: center;">Yes, disconnect.</p> </div> <p><b>Note:</b></p> <ul style="list-style-type: none"> <li>• Use parameters to set drive operation after you disconnect the smartphone or tablet and drive.</li> <li>• If the keypad is idle for longer than 60 seconds after you switch to Normal Operation Mode, the keypad will automatically go back to Bluetooth Mode.</li> <li>• Set <i>A1-12 = 0000 [Bluetooth ID = 0000]</i> to keep the keypad in Normal Operation Mode in these conditions: <ul style="list-style-type: none"> <li>–The keypad was idle, for example during Auto-Tuning</li> <li>–The keypad must not switch from Normal Operation Mode to Bluetooth Mode</li> </ul> </li> </ul>

### ◆ Bluetooth Mode

The operation of the keypad and smart device in Bluetooth Mode is different for different keypad versions. If you use a Bluetooth keypad with REV: C or earlier, refer to *Bluetooth Mode (REV: C or*

*Earlier) on page 46.* “REV” on the nameplate on the back of the keypad shows the keypad version.

### ■ Bluetooth Mode and Normal Operation Mode

The keypad operates in Bluetooth Mode and Normal Operation Mode.

- Bluetooth Mode

This mode uses a smartphone or tablet and DriveWizard Mobile to interface with the drive.

**Note:**

Set  $A1-12 \neq 0000$  [Bluetooth ID  $\neq 0000$ ] to enable Bluetooth when you energize the drive.

- Normal Operation Mode

- This mode uses the Bluetooth keypad to operate and monitor the drive.

- The keys operate the same as the keys on the standard keypad included with the drive. Refer to *Component Names and Functions on page 11* for more information.

- Push a key other than  when in Bluetooth Mode to disconnect Bluetooth communications and switch to Normal Operation Mode. Refer to *Disconnect Bluetooth Communications on page 30* for more information.

**Note:**

Set  $A1-12 = 0000$  to disable the Bluetooth connection. When  $A1-12 \neq 0000$ , push a key other than  when you are in Bluetooth Mode to temporarily disconnect Bluetooth communications and change to Normal Operation Mode. When the keypad is idle for longer than 60 seconds, the keypad will automatically go back to Bluetooth Mode, even after you change to Normal Operation Mode.

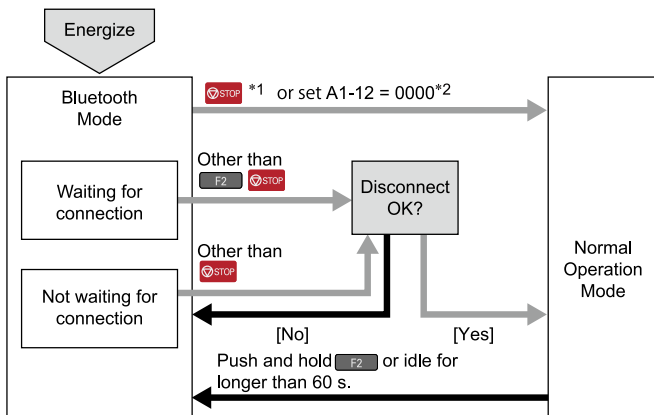











**Figure 5.5 Changing between Bluetooth Mode and Normal Operation Mode**

- \*1 Push  to stop drive operation.  
 \*2 Set  $A1-12 = 0000$  to disable the Bluetooth connection.

## ■ Key Functions in Bluetooth Mode

The  is the only key that operates the same in Bluetooth Mode and Normal Operation Mode. The other keys on the keypad will disconnect from Bluetooth Mode.

**Table 5.4 Key Functions**

Key	Function
	Stops drive operation and switches the keypad to Normal Operation Mode.
         	Shows the confirmation screen to disconnect Bluetooth Mode. Select [YES] to switch to Normal Operation Mode.

## ■ Bluetooth Mode Screen Displays

Table 5.5 shows the screen displays and connection statuses for the keypad.

**Table 5.5 Bluetooth Mode Screen Displays and Connection Statuses**

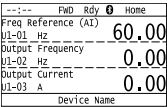
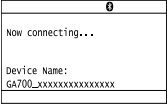
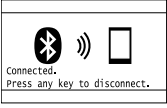
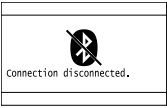
Screen Display	Connection Status
 <p>HOME Screen</p>  <p>Connection Standby Screen</p>	<ul style="list-style-type: none"> <li>The keypad is in standby and waiting for a Bluetooth connection.</li> <li>When you push <b>F2</b> (Device Name), the keypad shows the connection standby screen. When you push <b>F2</b> again, the keypad goes back to the home screen.</li> </ul>
	<ul style="list-style-type: none"> <li>The keypad is communicating with a smartphone or tablet.</li> <li>The keypad is waiting for the smartphone or tablet to enter the Bluetooth ID.</li> </ul>
	<p>There is a problem with the connection to the smartphone or tablet.</p> <p><b>Note:</b> After 2 seconds, the drive goes back to the connection standby screen.</p>

## ◆ Connecting the Keypad and Smart Device (REV: C or Earlier)

### ■ Prepare the Information Necessary for Connection (REV: C or Earlier)

Collect this information before you connect the keypad to a smartphone or tablet with Bluetooth communications:

1. Yaskawa Drive Cloud account Member ID and Password.

**Note:**

- Access the URL on the back cover of this manual to register for an account.
- For Japan: Member ID and password to the Yaskawa product and technical information website

2. Setting value of A1-12 [Bluetooth ID]

3. Drive series and serial number of the drive to which you will connect

**Note:**

- After you energize the drive, the keypad will show the connection standby screen. Confirm the [Device Name] at the bottom of this screen.

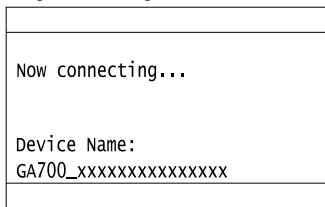

**Figure 5.6 Connection Standby Screen**



- Use the Device Name when you connect a smartphone or tablet to the drive to identify your drive from the other devices that are transmitting Bluetooth.

### ■ Install DriveWizard Mobile (REV: C or Earlier)

Download DriveWizard Mobile to your smartphone or tablet through the Apple App Store or Google Play Store.

- For Android devices: Google Play Store
- For iOS devices: App Store

Table 5.6 QR Codes

Google Play Store	App Store
	

Refer to [Table 5.7](#) for operating systems and drives compatible with the DriveWizard Mobile App.

Table 5.7 DriveWizard Mobile Specifications

Item	Description
Compatible Drive Series	<ul style="list-style-type: none"> <li>• YASKAWA AC Drive GA500</li> <li>• YASKAWA AC Drive GA700</li> <li>• YASKAWA AC Drive GA800</li> <li>• YASKAWA AC Drive CH700</li> <li>• YASKAWA AC Drive CR700</li> </ul>
Recommended Operating Environment for Smart Device	<ul style="list-style-type: none"> <li>• OS: Android 6.0, 7.0, 7.1, 8.0, 8.1 or iOS 10, 11, 12</li> <li>• Support for Bluetooth 4.0 or 4.1</li> </ul>

### ■ Connect to the Drive (REV: C or Earlier)

Use this procedure to launch DriveWizard Mobile and connect to the drive.

1. Start DriveWizard Mobile on your smartphone or tablet.



2. Tap [Log In] to Log into DriveWizard Mobile. Use your Drive Cloud ID and password.

If you do not have an account, tap [New Member Registration] to create an account before you continue.

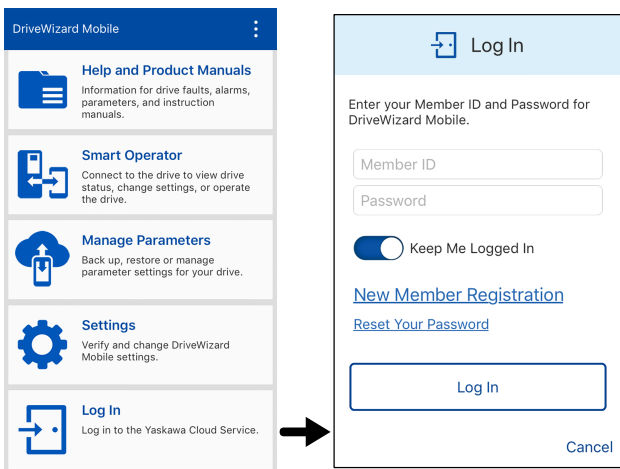

3. Tap [Help and Product Manuals] on the Home Screen, select the drive model to connect, and download the product information.

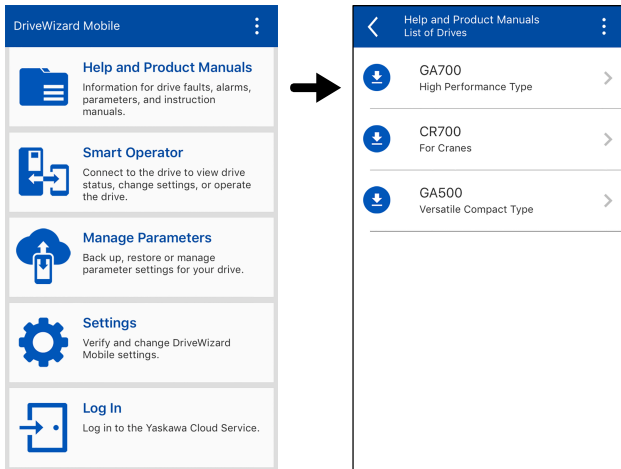

## 4. Tap [Smart Operator].



## 5. Select [Bluetooth] then tap [Connect].

**Note:**

This dialog screen is only for Android smart devices. Skip this step for iOS devices.

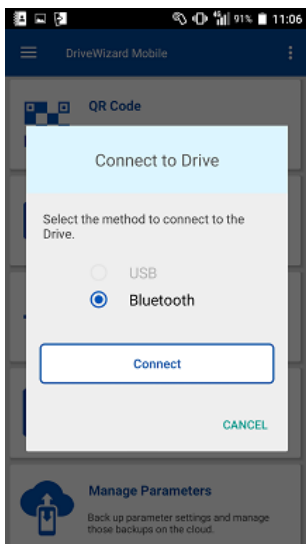

6. Tap the correct drive in the list of Bluetooth devices to make the connection.



**Note:**

- The device name of the drive is shown as "Drive Series\_Serial Number". If necessary, use the [Drive Information] menu in DriveWizard Mobile to change the "Serial Number" to a different value.
- If you did not download the product information of the connected drive, download the product information as specified by the dialog.

7. Make sure that the screen shows the correct drive information and tap [YES].

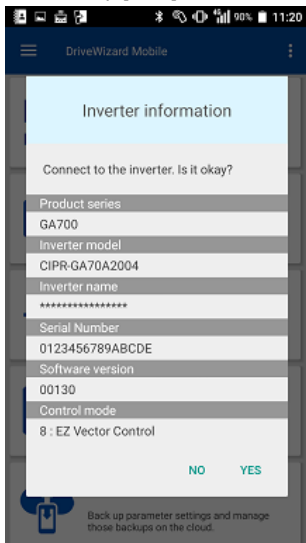

**Note:**

Make sure that the LED status ring of the connected drive is flashing. When you install the Bluetooth keypad on a GA500 drive, the drive will not have an LED status ring.

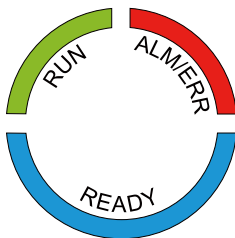

**Figure 5.7 LED Status Ring**

8. Enter the setting value of A1-12 [Bluetooth ID] on the Bluetooth ID Input screen and tap [OK].

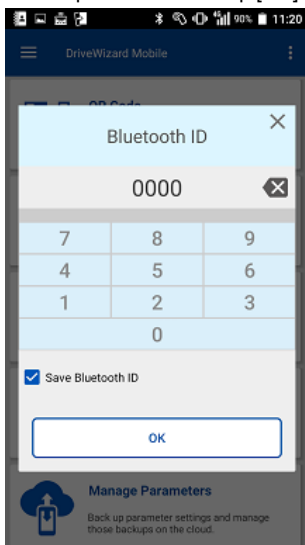

**Note:**

Check the [Save Bluetooth ID] checkbox to skip this step in the future.

When the drive connects to your smartphone or tablet, the smart device will show the list of *U1: [Operation Status Monitors]*.

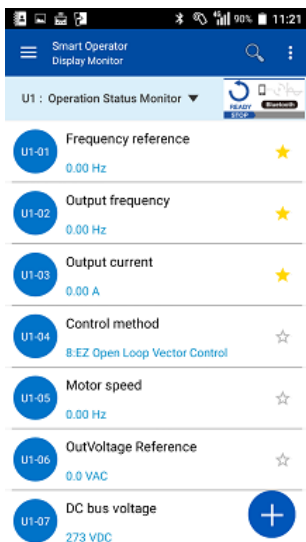

Bluetooth connection procedure is complete.



**Note:**

Refer to the DriveWizard Mobile Help for more information about how to use DriveWizard Mobile to operate the drive.

### ■ Disconnect Bluetooth Communications (REV: C or Earlier)

The operation to disconnect Bluetooth communications is different for different operating devices. [Table 5.8](#) lists the disconnection methods for each operating device.

Table 5.8 Operating Devices and Disconnection Method

Operating Device	Disconnection Method
Smartphone or Tablet	Go back to the DriveWizard Mobile App Home screen to disconnect communications with the keypad.
Keypad	<ul style="list-style-type: none"> <li>• Push  to stop communications between the smartphone or tablet and the drive and switch the keypad to Normal Operation Mode.</li> <li>• Push a key other than  to show the confirmation screen before you disconnect from the smartphone or tablet. Select [Yes, disconnect.] to disconnect and switch to Normal Operation Mode.</li> </ul> <div data-bbox="441 550 864 812" style="border: 1px solid black; padding: 10px; margin: 10px 0;"> <p style="text-align: center;">Disconnect Bluetooth mode?</p> <p style="text-align: center;"><b>No, continue.</b></p> <p style="text-align: center;">Yes, disconnect.</p> </div> <p><b>Note:</b></p> <ul style="list-style-type: none"> <li>• Use parameters to set drive operation after you disconnect the smartphone or tablet and drive.</li> <li>• If the keypad is idle for longer than 30 seconds after you switch to Normal Operation Mode, the keypad will automatically go back to Bluetooth Mode.</li> <li>• Push and hold  for 3 s to keep the keypad in Normal Operation Mode. <ul style="list-style-type: none"> <li>–The keypad was idle, for example during Auto-Tuning</li> <li>–The keypad must not switch from Normal Operation Mode to Bluetooth Mode</li> </ul> </li> </ul>

### ◆ Bluetooth Mode (REV: C or Earlier)

#### ■ Bluetooth Mode and Normal Operation Mode (REV: C or Earlier)

The keypad operates in Bluetooth Mode and Normal Operation Mode.

- Bluetooth Mode

This mode uses a smartphone or tablet and DriveWizard Mobile to interface with the drive.

**Note:**

The keypad will start in Bluetooth Mode when you energize the drive.

- Normal Operation Mode

- This mode uses the Bluetooth keypad to operate and monitor the drive.

- The keys operate the same as the keys on the standard keypad included with the drive. Refer to *Component Names and Functions on page 11* for more information.

- Push a key on the keypad when you are in Bluetooth Mode to disconnect Bluetooth communications and change to Normal Operation Mode. Refer to *Disconnect Bluetooth Communications (REV: C or Earlier) on page 44* for more information.

**Note:**

When the keypad is idle for longer than 30 seconds, the keypad will automatically go back to Bluetooth Mode, even after you change to Normal Operation Mode.

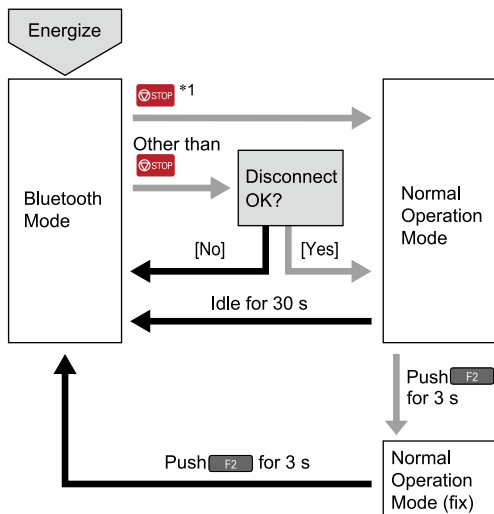

**Figure 5.8 Changing between Bluetooth Mode and Normal Operation Mode**

\*1 Push  to stop drive operation.

### ■ Key Functions in Bluetooth Mode (REV: C or Earlier)





The  is the only key that operates the same in Bluetooth Mode and Normal Operation Mode. The other keys on the keypad will disconnect from Bluetooth Mode.

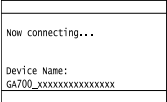
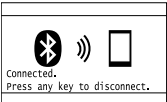

Table 5.9 Key Functions

Key	Function
	Stops drive operation and switches the keypad to Normal Operation Mode.
 	Shows the confirmation screen to disconnect Bluetooth Mode. Select [YES] to switch to Normal Operation Mode.

### ■ Bluetooth Mode Screen Displays (REV: C or Earlier)

Table 5.10 shows the screen displays and connection statuses for the keypad.

**Table 5.10 Bluetooth Mode Screen Displays and Connection Statuses**

Screen Display	Connection Status
	The keypad is in standby and waiting for a Bluetooth connection.
	<ul style="list-style-type: none"> <li>The keypad is communicating with a smartphone or tablet.</li> <li>The keypad is waiting for the smartphone or tablet to enter the Bluetooth ID.</li> </ul>
	<p>There is a problem with the connection to the smartphone or tablet.</p> <p><b>Note:</b> After 2 seconds, the drive goes back to the connection standby screen.</p>

## ◆ Remote Keypad Installation Methods

Installation Method	Features	Required Tools and Installation Support Sets
Outside the control panel	Installs the option on the outside of the panel. An optional installation bracket is not necessary for this installation.	Phillips screwdriver #2 (M3)
Inside the control panel	Installs the option on the Inside of the panel. Keypad does not extend farther than the front of the control panel.	<ul style="list-style-type: none"> <li>• Phillips screwdriver #2 (M3, M4)</li> <li>• Installation support set A (for mounting with screws, model: 900-192-933-001)</li> </ul>
		<ul style="list-style-type: none"> <li>• Phillips screwdriver #2 (M3)</li> <li>• Wrench (M4)</li> <li>• Installation support set B (for mounting with nut clamp, model: 900-192-933-002)</li> </ul>

### Note:

Installation support sets are sold separately. When there are weld studs on the interior of the control panel, use installation support set B.

## ■ Installation Procedure

The installation procedure is different for different drives.

Drive	Procedure	Page
GA700, GA800, CR700, CH700	A	<a href="#">52</a>
GA500	B	<a href="#">61</a>

## ■ Optional Items

The optional remote-control extension cable and installation support set are necessary for Internal/Flush-Mount installation.

Contact Yaskawa or your nearest sales representative to order mounting brackets and mounting hardware.

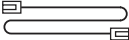
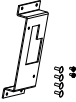
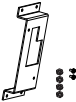
Optional Items	Model	Notes
Remote control extension cable (1 m (3.3 ft)) 	WV001 *1	Connects the keypad for remote operation. <ul style="list-style-type: none"> <li>• RJ-45 8-pin straight through</li> <li>• UTP CAT5e cable (1 m (3.3 ft)/3 m (9.8 ft))</li> </ul>
Remote control extension cable (3 m (9.8 ft)) 	WV003 *1	<div style="background-color: #0070C0; color: white; padding: 2px;"><b>NOTICE</b></div> <i>Damage to Equipment. Do not use this cable to connect the drive to a PC. Failure to obey will cause damage to the PC.</i>
Installation Support Set A (screw clamp) 	900-192-933-001	Encloses the keypad in the panel. <ul style="list-style-type: none"> <li>• M3 screws: 6 mm (0.24 in) depth Phillips recessed pan head machine screws (2)</li> <li>• M4 screws: 10 mm (0.39 in) depth Phillips truss head screws (4) (for panel thickness of 1 to 1.6 mm (0.04 to 0.06 in))</li> </ul>
Installation Support Set B (nut clamp) 	900-192-933-002	Encloses the keypad in the panel. When there are weld studs on the interior of the control panel, use the installation support set B (nut clamp). <ul style="list-style-type: none"> <li>• M3 screws: 6 mm (0.24 in) depth Phillips recessed pan head machine screws (2)</li> </ul>

\*1 Part numbers for the Americas are UWR0051 and UWR0052. Contact Yaskawa or your nearest sales representative for more information.

## External Dimensions of Keypad

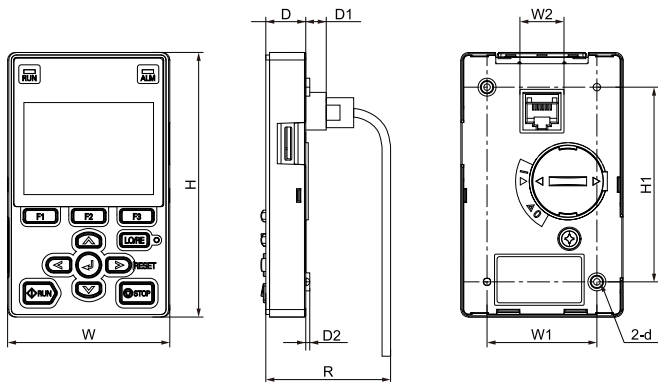

Figure 5.9 Exterior and Mounting Dimensions

Table 5.11 Dimensions mm (in)

W	H	D	D1	D2	R *1	W1	W2	H1	d
65 (2.56)	106 (4.17)	16 (0.63)	8.2 (0.32)	1.6 (0.06)	$\geq 53.8$ (2.12)	44 (1.73)	15 (0.59)	78 (3.07)	M3

\*1 Minimum bending radius

**NOTICE** *Damage to Equipment. Do not bend the communication cables more than the bend radius specifications. If you bend the cables too much, it can break the wires and loosen connections.*

## ■ Procedure A

### External/Face-Mount Installation

1. Use the dimensions in [Table 5.12](#) and [Figure 5.10](#) to cut an opening and tap two holes in the enclosure panel.

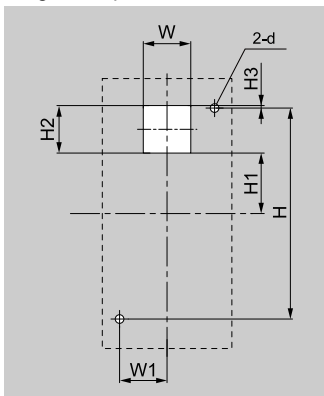
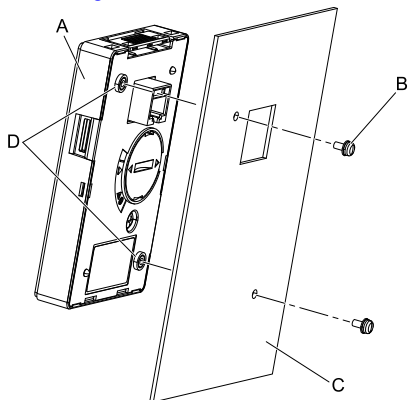

**Figure 5.10 External/Face Mount Enclosure Panel Cut-Out Dimensions**

**Table 5.12 Enclosure Panel Cut-Out Dimensions mm (in.)**

W	H	W1	H1	H2	H3	d
22 (0.87)	78 (3.07)	22 (0.87)	29 (1.14)	22 (0.87)	1 (0.04)	3.6 (0.14)

- Use M3 screws (6 mm (0.24 in) depth cross-recessed pan head screws) to attach the keypad from the inside as shown in [Figure 5.11](#).



A - Keypad

B - M3 screws

C - Enclosure panel

D - Screw mounting hole

**Figure 5.11 External/Face-Mount Installation**

- Push the tab on the top of the drive keypad and carefully pull forward to remove the keypad from the drive.

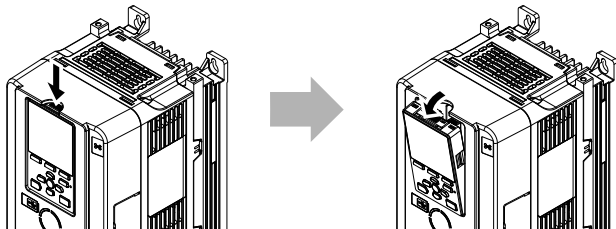

**Figure 5.12 Removing the Included Drive Keypad**

4. Remove the keypad connector and put the keypad connector in the holder on the front cover.

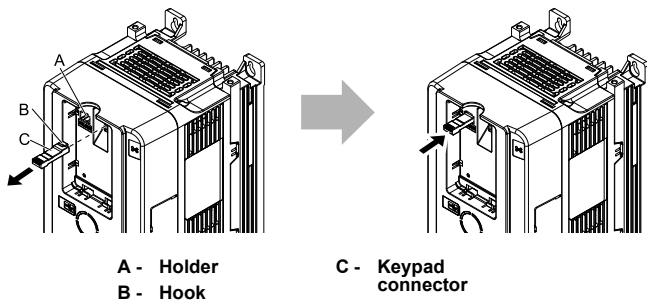

**Figure 5.13 Moving the Keypad Connector to the Holder**

5. Use the extension cable to connect the drive to the keypad.

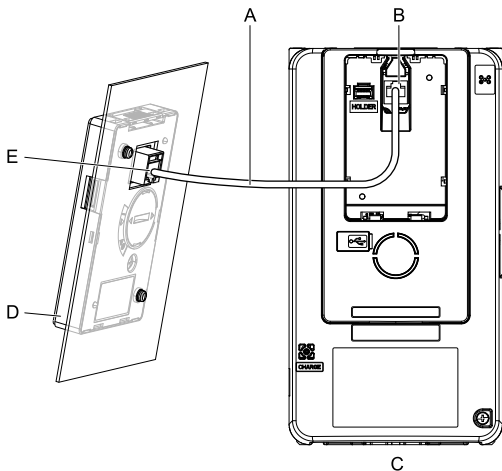

- |                                     |                            |
|-------------------------------------|----------------------------|
| <b>A - Extension cable</b>          | <b>D - Keypad</b>          |
| <b>B - Communications connector</b> | <b>E - Cable connector</b> |
| <b>C - Drive</b>                    |                            |

**Figure 5.14 Connecting the Drive and Keypad with the Extension Cable**

#### Internal/Flush-Mount Installation

Installation support sets A or B (sold separately) are necessary for Internal/Flush-Mount installation. The installation procedure is the same for installation support sets A and B. Contact Yaskawa or your nearest sales representative to order optional items.

1. Use the dimensions in [Table 5.13](#) and [Figure 5.15](#) to cut an opening and tap two holes in the enclosure panel. The panel cut-out dimensions are the same for installation support sets A and B.

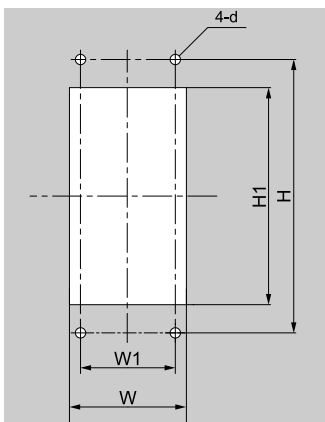
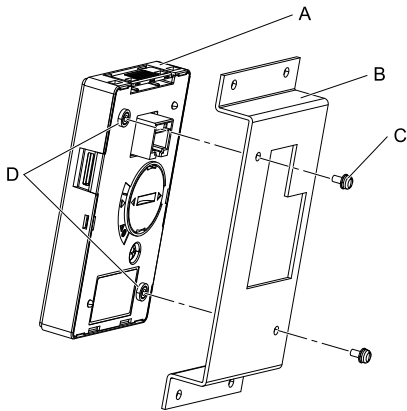

**Figure 5.15 Internal/Flush-Mount Enclosure Panel Cut-Out Dimensions**

**Table 5.13 Enclosure Panel Cut-Out Dimensions mm (in.)**

<b>W</b>	<b>H</b>	<b>W1</b>	<b>H1</b>	<b>d</b>
64 + 0.5 (2.52 + 0.02)	130 (5.12)	45 (1.77)	105 + 0.5 (4.13 + 0.02)	4.8 (0.19)

2. Use the screws included in the support set as shown in [Figure 5.16](#) to attach the keypad to the installation support.



A - Keypad  
B - Installation  
support set A

C - M3 screws  
D - Screw mounting  
hole

**Figure 5.16 Mounting the Keypad to Installation Support Set A**

3. Use the M4 screws included in the support set as shown in [Figure 5.17](#) to attach the installation support and keypad to the enclosure panel.

**Note:**

Use a gasket between the control panel and the keypad in areas where dust or other airborne unwanted materials could cause damage to the drive.

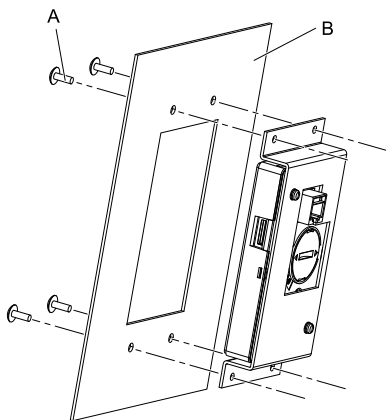

A - M4 screws

B - Enclosure panel

**Figure 5.17 Internal/Flush-Mount Installation**

4. Push the tab on the top of the drive keypad and carefully pull forward to remove the keypad from the drive.

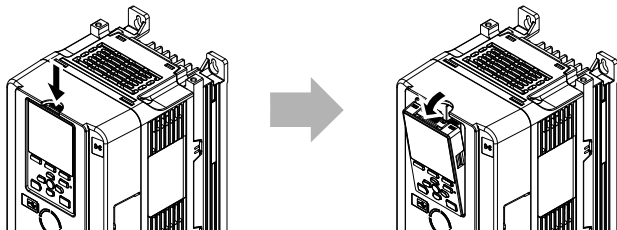

**Figure 5.18 Removing the Included Drive Keypad**

5. Remove the keypad connector and put the keypad connector in the holder on the front cover.

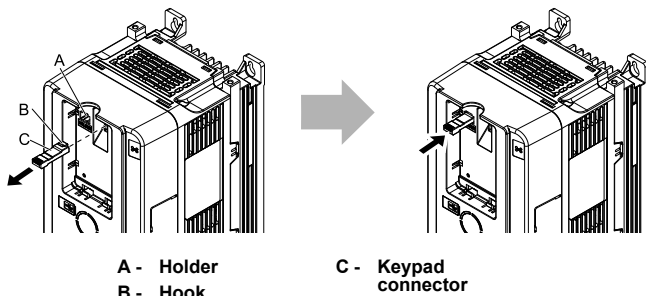

**Figure 5.19 Moving the Keypad Connector to the Holder**

6. Use the extension cable to connect the drive to the keypad.

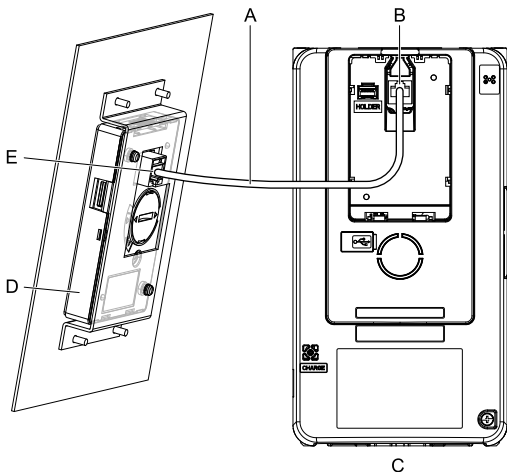

- A - Extension cable      D - Keypad  
B - Communications      E - Cable connector  
   connector  
C - Drive

**Figure 5.20 Connecting the Drive and Keypad with the Extension Cable**

## ■ Procedure B

### External/Face-Mount Installation

1. Use the dimensions in [Table 5.14](#) and [Figure 5.21](#) to cut an opening and tap two holes in the enclosure panel.

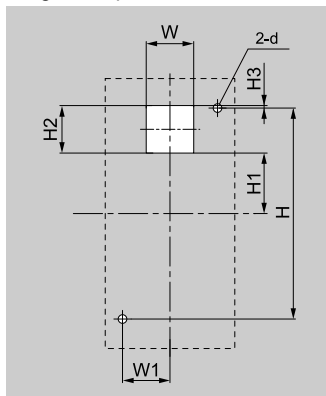
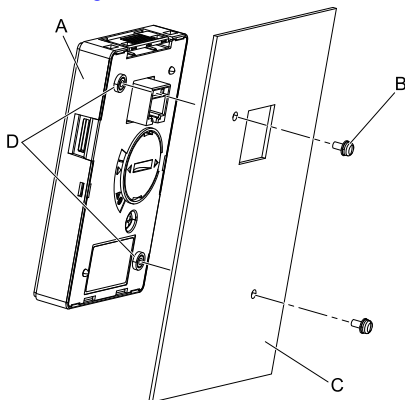

**Figure 5.21 External/Face Mount Enclosure Panel Cut-Out Dimensions**

**Table 5.14 Enclosure Panel Cut-Out Dimensions mm (in.)**

W	H	W1	H1	H2	H3	d
22 (0.87)	78 (3.07)	22 (0.87)	29 (1.14)	22 (0.87)	1 (0.04)	3.6 (0.14)

- Use M3 screws (6 mm (0.24 in) depth cross-recessed pan head screws) to attach the keypad from the inside as shown in [Figure 5.22](#).



A - Keypad

B - M3 screws

C - Enclosure panel

D - Screw mounting holes

**Figure 5.22 External/Face-Mount Installation**

- Use a slotted screwdriver to unlock the front cover of the drive.

Use a slotted screwdriver with a tip width of 2.5 mm (0.1 in) or less and a thickness of 0.4 mm (0.02 in) or less.

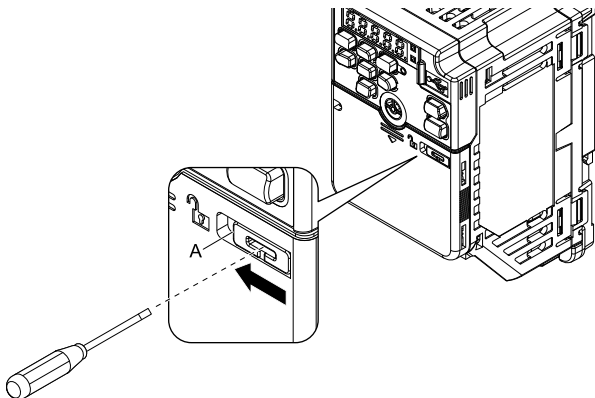

A - Front cover lock

**Figure 5.23 Unlocking**

4. Slide the front cover down and remove it from the drive.

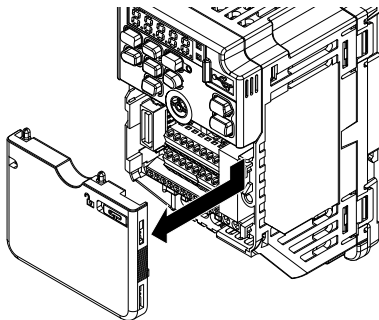

**Figure 5.24 Remove the Front Cover**

5. Push on the tab on the right side of the keypad, then pull the keypad forward to remove it from the drive.

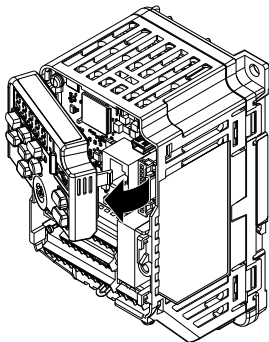

**Figure 5.25 Removing the Included Drive Keypad**

- Use the extension cable to connect the drive to the keypad.

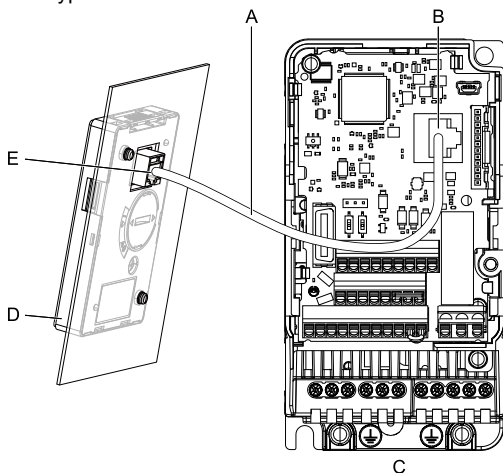

- |                              |                     |
|------------------------------|---------------------|
| A - Extension cable          | D - Keypad          |
| B - Communications connector | E - Cable connector |
| C - Drive                    |                     |

**Figure 5.26 Connecting the Drive and Keypad with the Extension Cable**

#### Internal/Flush-Mount Installation

Installation support sets A or B (sold separately) are necessary for Internal/Flush-Mount installation. The installation procedure is the same for installation support sets A and B. Contact Yaskawa or your nearest sales representative to order optional items.

- Use the dimensions in [Table 5.15](#) and [Figure 5.27](#) to cut an opening in the control panel for the keypad.  
The panel cut-out dimensions are the same for installation support sets A and B.

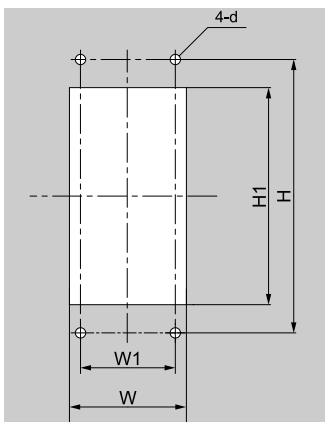
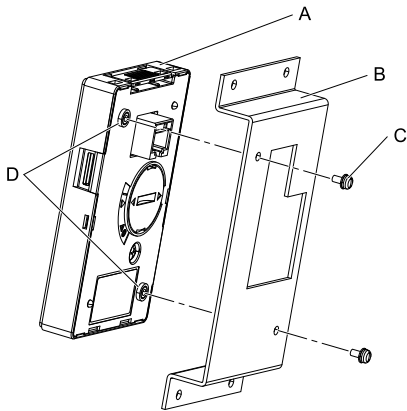

**Figure 5.27 Internal/Flush-Mount Enclosure Panel Cut-Out Dimensions**

**Table 5.15 Enclosure Panel Cut-Out Dimensions mm (in.)**

W	H	W1	H1	d
64 + 0.5 (2.52 + 0.02)	130 (5.12)	45 (1.77)	105 + 0.5 (4.13 + 0.02)	4.8 (0.19)

- Use the screws included in the support set as shown in [Figure 5.28](#) to attach the keypad to the installation support.



A - Keypad  
B - Installation  
support set A

C - M3 screws  
D - Screw mounting  
hole

**Figure 5.28 Mounting the Keypad to Installation Support Set A**

- Use the M4 screws included in the support set as shown in [Figure 5.29](#) to attach the installation support and keypad to the enclosure panel.

**Note:**

Use a gasket between the control panel and the keypad in areas where dust or other airborne unwanted materials could cause damage to the drive.

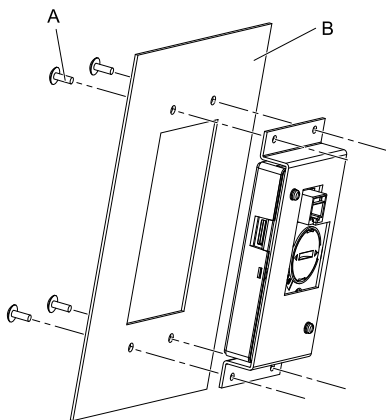

**A - M4 screws**

**B - Enclosure panel**

### Figure 5.29 Internal/Flush-Mount Installation

4. Use a slotted screwdriver to unlock the front cover of the drive.

Use a slotted screwdriver with a tip width of 2.5 mm (0.1 in) or less and a thickness of 0.4 mm (0.02 in) or less.

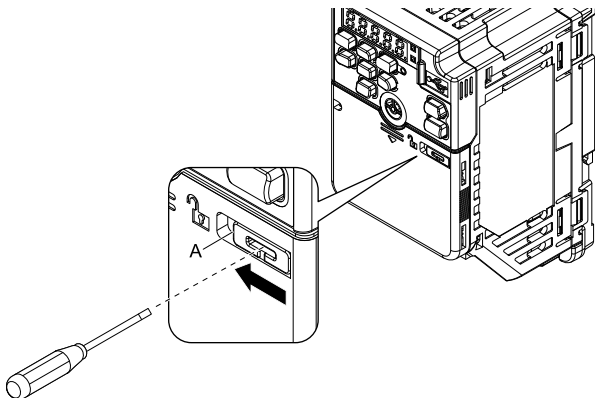

A - Front cover lock

**Figure 5.30 Unlocking**

5. Slide the front cover down and remove it from the drive.

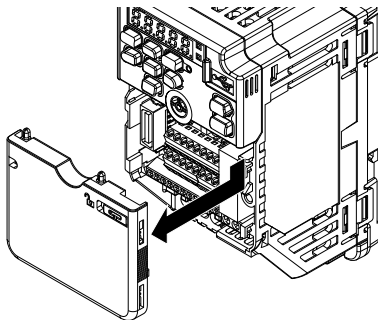

**Figure 5.31 Remove the Front Cover**

6. Push on the tab on the right side of the keypad, then pull the keypad forward to remove it from the drive.

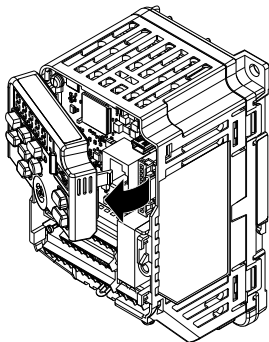

**Figure 5.32 Removing the Included Drive Keypad**

7. Use the extension cable to connect the drive to the keypad.

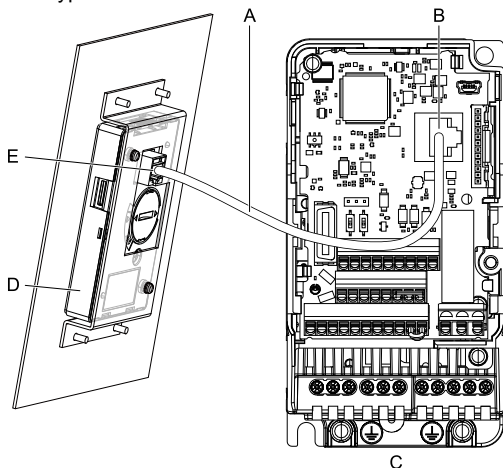

- A - Extension cable    D - Keypad  
 B - Communications connector    E - Cable connector  
 C - Drive

**Figure 5.33 Connecting the Drive and Keypad with the Extension Cable**

### ◆ Replace the Keypad Battery

When the keypad battery is expired, the date and time go back to the default settings. Use this procedure to replace the battery.

**⚠ WARNING** *Fire Hazard. Handle keypad batteries properly. Do not charge the battery or disassemble the keypad. If the battery explodes, it can cause a fire.*

To replace the battery, use a Hitachi Maxell “CR2016 Lithium Manganese Dioxide Lithium Battery” or an equivalent battery with these properties:

- Nominal voltage: 3 V
- Operating temperature range: -20 °C to + 85°C (-4 °F to +185 °F)

**⚠ WARNING** *Fire Hazard. Do not disassemble batteries. Do not expose batteries to heat or fire. If the battery explodes, it can cause a fire.*

**NOTICE** *Damage to Equipment. The keypad battery stays in use after you de-energize the drive. When you will keep the drive de-energized for long periods of time, remove the battery from the keypad. When the expected life of the battery is complete, replace the battery immediately. A dead battery in the keypad can leak and cause damage to the keypad and drive.*

The performance life estimate of a new battery is:

- Ambient temperature 20 °C (68 °F): 5 years
- Ambient temperature -10 °C to +50 °C (14 °F to 122 °F): 3.5 years

1. De-energize the drive and remove the keypad.

2. Use a slotted screwdriver or other tool to turn the battery cover counterclockwise and remove the cover.

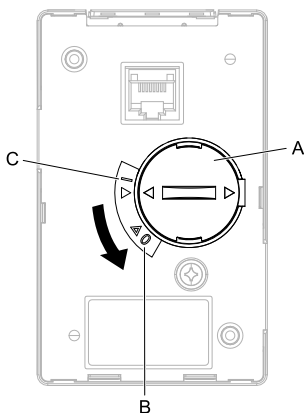

- A - Battery cover**      **C - Closed**  
**B - Opened**

**Figure 5.34 Remove the Battery Cover**

3. Remove the used battery from the keypad.
4. Insert the new battery.

**Note:**

- The battery cover side is the positive pole. Make sure that the polarity is correct when you put the battery in the keypad.
- Discard the used battery as specified by local regulations.

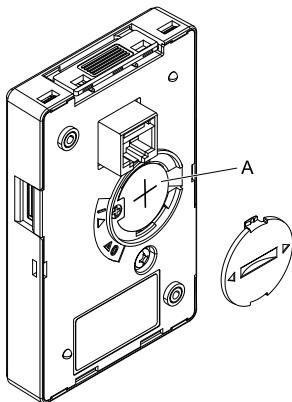

**A - Battery**

**Figure 5.35 Insert the New Battery**

5. Put the battery cover on the keypad and use a slotted screwdriver to turn the battery cover clockwise to close it.
6. Install the keypad on the drive.

## 6 Related Parameters

These parameters set the drive to operate with Bluetooth Keypad. Set parameters as necessary. Refer to the drive manual for information about how to set parameters.

No. (Hex.)	Name	Description	Default (Range)
A1-12 (1564)	Bluetooth ID	Sets the password necessary to use Bluetooth to control the drive with a smartphone or tablet. Refer to the drive manual for the default setting. For keypad versions REV: G or later, set <i>A1-12 = 0000</i> to disable the Bluetooth connection.	- (0000 - 9999)
o2-27 (1565)	bCE Detection Selection	Sets drive operation if the Bluetooth device is disconnected when you operate the drive in Bluetooth Mode. Refer to the drive manual for the default setting. 0 : Ramp to Stop 1 : Coast to Stop 2 : Fast Stop (Use <i>C1-09</i> ) 3 : Alarm Only 4 : No Alarm Display	- (0 - 4)

## 7 Fault Diagnostics and Solutions

Code	Name	Causes	Possible Solutions
bCE	Bluetooth Communication Fault	The smartphone or tablet with DriveWizard Mobile installed is too far from the keypad.	Use the smartphone or tablet 10 m (32.8 ft) or nearer to the keypad.  <b>Note:</b> <i>bCE</i> can occur when the smartphone or tablet is 10 m (32.8 ft) or nearer to the keypad depending on the specifications of the smartphone or tablet.
		Radio waves from a different device are causing interference with communications between the smartphone or tablet and keypad.	Make sure that no device around the keypad uses the same radio bandwidth (2400 MHz to 2480 MHz), and prevent radio interference.

### ◆ Smartphones or Tablets Cannot Connect to the Keypad

Causes	Possible Solutions
Do not know the Bluetooth ID.	Use the keypad to check the value set in <i>A1-12 [Bluetooth ID]</i> .
Drive software is not compatible with the keypad.	Check the drive software version.  <b>Note:</b> The keypad shows the alarm code.
The smartphone or tablet with DriveWizard Mobile installed is too far from the keypad.	Use the smartphone or tablet 10 m (32.8 ft) or nearer to the keypad.  <b>Note:</b> The smartphone or tablet and the keypad could possibly not connect in distances nearer than 10 m (32.8 ft) because of smartphone or tablet specifications.

Causes	Possible Solutions
The keypad is not in Bluetooth Mode.	<ul style="list-style-type: none"> <li>• Wait for 60 seconds minimum and do not push a key on the keypad until the keypad switches from Normal Operation Mode to Bluetooth Mode</li> <li>• Set <math>A1-12 \neq 0000</math> [<i>Stall Prevention during Decel <math>\neq</math> Disabled</i>] to enable stall prevention.</li> <li>• Remove and connect the keypad again.</li> </ul>
The Bluetooth radio/protocol version is not compatible with the keypad.	Make sure that the smartphone or tablet supports Bluetooth 4.0 or 4.1.
Radio waves from a different device are causing interference with communications between the smartphone or tablet and keypad.	Make sure that no device around the keypad uses the same radio bandwidth (2400 MHz to 2480 MHz), and prevent radio interference.
There is damage to the keypad circuit board.	Replace the keypad. <b>Note:</b> The keypad will show [Bluetooth Initializing...], and will not continue to the [Now connecting...] screen. The keypad will let the show an alarm.

## 8 Standards Compliance

This section gives the guidelines to use to comply with standards about machines and devices that use this product in different countries.

### ◆ European Standards (RE Directives)

This product complies with the EU Radio Equipment Directive (RED).

Importers, distributors, and manufacturers may be responsible for damages under this RED wireless directive.

### ◆ FCC and IC Certifications

The following Federal Communications Commission (FCC) and Industry Canada (IC) certifications compliance identification numbers have been assigned to this product:

- FCC ID: WAP2001
- IC: 7922A-2001

### ■ FCC ID: WAP2001

This product complies with Part 15 of the FCC Rules.

The operation of this product is subject to the following two criteria:

- This product will not cause harmful interference.
- This product is not susceptible to issues of interference including malfunction.

#### Note:

- This product has been tested and certified as compliant with Part 15 of FCC regulations as a Class A digital device. These regulations are intended to adequately protect against negative effects of interference when devices are used in commercial environments. This product generates and utilizes radio wave energy, and therefore can be a source of radiation. Failure to install and use this product in accordance with the manuals may result in the causing of harmful wireless interference. Using this device in residential areas may cause harmful interference. The customer shall be responsible for any consequences of using this product in such environments.
- Yaskawa may demand the disuse of this product if you or your customer modifies the product.

### ■ IC7922A-2001

This product is compliant with RSS-GEN requirements. The operation of this product is subject to the following two criteria:

- This product will not cause harmful interference.
- This product is not susceptible to issues of interference including malfunction.

---

---

### ◆ CMIIT Certification

The following China Radio Low (CMIIT) certification compliance identification numbers have been assigned to this product:

#### ■ CMIIT ID: 2017DP5761

This product complies with CMIIT Rules.

---

### ◆ Japan Radio Law



**Figure 8.1 Technical Conformity Mark**

This product is compliant with the Japan Radio Law.

## 9 Disposal Instructions

Correctly discard these parts and materials as specified by regional, local, and municipal laws and regulations for this product:

- Battery
- microSD card

**▲ CAUTION** *Fire Hazard. Put electrical tape fully around the battery before you discard it. If you do not correctly discard the battery, it can cause a fire.*

**Note:**

- Remove the battery and microSD card from the keypad.
- You cannot recycle the battery. Discard used batteries as specified by the battery manufacturer.
- Customers are responsible for microSD card data protection. PC functions that format and delete the data may not be sufficient to fully erase the microSD card data. Yaskawa recommends that customers physically destroy the microSD card in a shredder or use data wipe software to fully erase the card.

## ◆ WEEE Directive



The wheeled bin symbol on this product, its manual, or its packaging identifies that you must recycle it at the end of its product life.

You must discard the product at an applicable collection point for electrical and electronic equipment (EEE). Do not discard the product with usual waste.

## 10 Specification

**Table 10.1 Option Hardware Specifications (Common)**

Item	Description
Model	<ul style="list-style-type: none"> <li>Standard specifications: JVOPKPLCC04Axx</li> <li>Moisture resistance and dust resistance specifications: JVOP-KPLCC04Mxx</li> </ul>
Port	RJ-45
Power Supply	Supply from drive (DC +5 V $\pm$ 5%)
Operating Ambient Temperature	-10 °C to +50 °C (14 °F to 122 °F)
Operating Ambient Humidity	95% RH or less (no condensation)
Storage Ambient Temperature	-20 °C to +70 °C (-4 °F to +158 °F) (short-term storage temperature during transport)

Item	Description
Area of Use	Indoor (an area without corrosive gas, or dust)
Altitude	1000 m (3281 ft) Maximum
Vibration	10 Hz to 20 Hz: 9.8 m/s <sup>2</sup> (1 G) 20 Hz to 55 Hz: 5.9 m/s <sup>2</sup> (0.6 G)
Harmonized Standard	<ul style="list-style-type: none"> <li>• European Standards (CE)</li> <li>• Federal Communications Commission (FCC)</li> <li>• Industry Canada (IC)</li> <li>• China Radio Law (CMIIT)</li> <li>• Japan Radio Law (MIC)</li> </ul>
Approximate Number of Parameter Reads	100,000 maximum
Battery for Clock Backup	<p>Not supplied with the keypad.</p> <p>Yaskawa recommends a Hitachi Maxell "CR2016 Lithium Manganese Dioxide Lithium Battery" or an equivalent battery with these properties:</p> <p>Battery life:</p> <ul style="list-style-type: none"> <li>• 5 years (20 °C (68 °F), when the battery is new)</li> <li>• 3.5 years (-10 °C to +50 °C (14 °F to 122 °F), when the battery is new)</li> </ul>

**Table 10.2 Moisture Resistance and Dust Resistance Specifications**

Item	Description
Model	JVOP- KPLCC04MxA
Specification	Board surfaces: Apply insulating varnish (HumiSeal) to entire surface of the board excluding connectors.
Battery for Clock Backup	Not supplied with the keypad.

**Table 10.3 Moisture Resistance and Dust Resistance Specifications, Battery Supplied**

Item	Description
Model	JVOP-KPLCC04MxB
Specification	Board surfaces: Apply insulating varnish (HumiSeal) to entire surface of the board excluding connectors.
Battery for Clock Backup	Supplied with the keypad.

**Table 10.4 Bluetooth Communication Specifications**

Item	Description
Bluetooth Standard	Bluetooth Ver. 4.1 Single Mode (Smart)
Certification	Bluetooth SIG Registered
Antenna Type	Planar-inverted F-type internal PCB antenna
Radio Band	2400 to 2480 MHz
Antenna Gain	Maximum of 0.5 dBi

## 11 Warranty

### ◆ Warranty Period

The period is 12 months from the date the product is first used by the buyer, or 18 months from the date of shipment, whichever occurs first.

### ◆ Post-Warranty Repair Period

The post-warranty repair period applies to products that are not in the standard warranty period. During the post-warranty repair period, Yaskawa will repair or replace damaged parts for a fee.

---

There is a limit to the period during which Yaskawa will repair or replace damaged parts. Contact Yaskawa or your nearest sales representative for more information.

---

### ◆ Cyber Security Disclaimers

This product is designed to transmit and receive data over a network interface. Users are responsible for network security regarding connectivity between this product and the customer network or some other network. Users are responsible for establishing and maintaining appropriate systems (such as firewalls, authentication, data encryption, and antivirus software) to protect the product, networks, systems, and interfaces against any kind of security breaches, unauthorized access, interference, intrusion, and loss/theft of data or information.

Yaskawa and its affiliates shall not be liable for any damages incurred due to security breaches, unauthorized access, interference, intrusion, and loss/theft of data.

---

### ◆ About Application of This Product

This product is not designed or manufactured for use in life-support machines or systems.

Contact a Yaskawa representative or your Yaskawa sales representative if you are considering the application of this product for special purposes, such as machines or systems used for passenger cars, medicine, airplanes and aerospace, nuclear power, electric power, or undersea relaying.

#### **⚠ WARNING**

*Injury to Personnel. When you use this product in applications where its failure could cause the loss of human life, a serious accident, or physical injury, you must install applicable safety devices. If you do not correctly install safety devices, it can cause serious injury or death.*

## Revision History

Date of Publication	Revision Number	Section	Revised Content
May 2019	3	All	Revision: Revision: Reviewed and corrected entire documentation. Upgraded keypad software version to REV: G. Addition: Compatible models <ul style="list-style-type: none"> <li>• GA800</li> <li>• GA500</li> </ul>
		Chapter 5	Revision: Bluetooth Mode and Normal Operation Mode Addition: Installation procedure for GA500 drives
		Chapter 8	Deletion: Precautions for Korean Radio Waves Act
		Chapter 9	Addition: WEEE Directive
May 2018	2	All	Addition: <ul style="list-style-type: none"> <li>• Support for iOS of DriveWizard Mobile</li> <li>• China Radio Law</li> </ul>
June 2017	1	All	Revision: Reviewed and corrected entire documentation
		Chapter 2	Addition: Compatible models <ul style="list-style-type: none"> <li>• CR700</li> <li>• CH700</li> </ul>
		Chapter 8	Addition: Precautions for Korean Radio Waves Act
		Chapter 9	Addition: Disposal Instructions
September 2016	-	-	First Edition



# Yaskawa AC Drive Option Bluetooth LCD Keypad Installation Manual

---

## **DRIVE CENTER (INVERTER PLANT)**

2-13-1, Nishimiyaichii, Yukuhashi, Fukuoka,  
824-8511, Japan  
Phone: +81-930-25-2548 Fax: +81-930-25-3431  
<http://www.yaskawa.co.jp>

## **YASKAWA ELECTRIC CORPORATION**

New Pier Takeshiba South Tower, 1-16-1, Kaigan,  
Minatoku, Tokyo, 105-6891, Japan  
Phone: +81-3-5402-4502 Fax: +81-3-5402-4580  
<http://www.yaskawa.co.jp>

## **YASKAWA AMERICA, INC.**

2121, Norman Drive South, Waukegan, IL 60085, U.S.A.  
Phone: +1-800-YASKAWA (927-5292) or +1-847-887-7000  
Fax: +1-847-887-7310  
<http://www.yaskawa.com>

## **YASKAWA ELÉTRICO DO BRASIL LTDA.**

777, Avenida Piraporinha, Diadema, São Paulo,  
09950-000, Brasil  
Phone: +55-11-3585-1100 Fax: +55-11-3585-1187  
<http://www.yaskawa.com.br>

## **YASKAWA EUROPE GmbH**

Hauptstraße 185, 65760 Eschborn, Germany  
Phone: +49-6196-569-300 Fax: +49-6196-569-398  
E-mail: [info@yaskawa.eu.com](mailto:info@yaskawa.eu.com)  
<http://www.yaskawa.eu.com>

## **YASKAWA ELECTRIC KOREA CORPORATION**

35F, Three IFC, 10 Gukjegeumyung-ro,  
Yeongdeungpo-gu, Seoul, 07326, Korea  
Phone: +82-2-784-7844 Fax: +82-2-784-8495  
<http://www.yaskawa.co.kr>

## **YASKAWA ASIA PACIFIC PTE. LTD.**

30A, Kallang Place, #06-01, 339213, Singapore  
Phone: +65-6282-3003 Fax: +65-6289-3003  
<http://www.yaskawa.com.sg>

## **YASKAWA ELECTRIC (THAILAND) CO., LTD.**

59, 1st-5th Floor, Flourish Building, Soi Ratchadapisek 18,  
Ratchadapisek Road, Huaykwang, Bangkok, 10310,  
Thailand  
Phone: +66-2-017-0099 Fax: +66-2-017-0799  
<http://www.yaskawa.co.th>

## **YASKAWA ELECTRIC (CHINA) CO., LTD.**

22F, Link Square 1, No.222, Hubin Road, Shanghai,  
200021, China  
Phone: +86-21-5385-2200 Fax: +86-21-5385-3299  
<http://www.yaskawa.com.cn>

## **YASKAWA ELECTRIC (CHINA) CO., LTD. BEIJING OFFICE**

Room 1011, Tower W3 Oriental Plaza, No. 1,  
East Chang An Ave.,  
Dong Cheng District, Beijing, 100738, China  
Phone: +86-10-8518-4086 Fax: +86-10-8518-4082

## **YASKAWA ELECTRIC TAIWAN CORPORATION**

12F, No. 207, Sec. 3, Beishin Rd., Shindian Dist.,  
New Taipei City 23143, Taiwan  
Phone: +886-2-8913-1333  
Fax: +886-2-8913-1513 or +886-2-8913-1519  
<http://www.yaskawa.com.tw>

## **YASKAWA INDIA PRIVATE LIMITED**

#17/A, Electronics City, Hosur Road, Bangalore,  
560 100 (Karnataka), India  
Phone: +91-80-4244-1900 Fax: +91-80-4244-1901  
<http://www.yaskawaindia.in>

---

# YASKAWA

**YASKAWA ELECTRIC CORPORATION**

In the event that the end user of this product is to be the military and said product is to be employed in any weapons systems or the manufacture thereof, the export will fall under the relevant regulations as stipulated in the Foreign Exchange and Foreign Trade Regulations. Therefore, be sure to follow all procedures and submit all relevant documentation according to any and all rules, regulations and laws that may apply.

Specifications are subject to change without notice for ongoing product modifications and improvements.

© 2016 YASKAWA Electric Corporation



\*T0EPC73060094\*

MANUAL NO. TOEP C730600 94D <3>-0  
Published in Japan May 2019  
18-11-12