



VS mini J7 Series Instruction Manual

COMPACT GENERAL-PURPOSE INVERTER
(VOLTAGE VECTOR CONTROL)

PREFACE

YASKAWA's VS mini J7 is a compact and simple inverter that is as easy to use as a contactor. This instruction manual describes installation, maintenance, inspection, troubleshooting, and specifications of the VS mini J7. Read this instruction manual thoroughly before operation.

YASKAWA ELECTRIC CORPORATION

General Precautions

- Some drawings in this manual are shown with the protective covers and shields removed, in order to illustrate detail with more clarity. Make sure all covers and shields are replaced before operating this product.
- This manual may be modified when necessary to reflect improvements to the product, or changes in specifications.
Such modifications are denoted by a revised manual No.
- To order a copy of this manual, contact your YASKAWA representative.
- YASKAWA is not responsible for any modification of the product made by the user. Any modifications will void the warranty.

CONTENTS

NOTES FOR SAFE OPERATION.....	5
1. RECEIVING	12
• Checking the Name Plate	12
2. IDENTIFYING THE PARTS	13
3. SPECIFICATIONS	15
• Standard Specifications (200V Class).....	15
• Standard Specifications (400V Class).....	18
• Standard Wiring.....	21
• Dimensions	23
• Parameters List	25
4. MOUNTING.....	35
• Choosing a Location to Mount the Inverter	35
• Mounting Dimensions	36
• Mounting/Removing Components	37
5. WIRING.....	39
• Wiring Instructions.....	39
• Wire and Terminal Screw Sizes	39
• Wiring the Main Circuit	42
• Recommended Peripheral Devices.....	43
• Wiring the Control Circuit.....	45
• Wiring Inspection.....	46
6. OPERATING THE INVERTER	47
• Test Run	47
• Operating the Digital Operator.....	49
• LED Description.....	51
• Simple Data Setting.....	55

7. PROGRAMMING FEATURES	57
• Parameter Set-up and Initialization	57
• Setting V/f pattern	58
• Switching LOCAL/REMOTE Modes	61
• Selecting Run/Stop Commands.	62
• Selecting Frequency Reference	63
• Setting Operation Condition	65
• Selecting Stopping Method	82
• Building Interface Circuits with External Devices.	84
• Setting Frequency by Current Reference Input.	89
• Decreasing Motor Speed Fluctuation	93
• Motor Protection	94
• Selecting Cooling Fan Operation.	96
• Using MEMOBUS (MODBUS) Communications (when option card is installed).	96
8. MAINTENANCE AND INSPECTION	99
• Periodical Inspection	99
• Part Replacement	99
9. FAULT DIAGNOSIS AND CORRECTIVE ACTIONS.	103
APPENDIX	111
• CE Conformance	111

NOTES FOR SAFE OPERATION

Read this instruction manual thoroughly before installation, operation, maintenance or inspection of the VS mini. In this manual, NOTES FOR SAFE OPERATION are classified as “WARNING” or “CAUTION”.



Indicates a potentially hazardous situation which, if not avoided, could result in death or serious injury to personnel.



Indicates a potentially hazardous situation which, may result in minor or moderate injury to personnel, and possible damage to equipment if not avoided. It may also be used to alert against unsafe practices.

Items described in

 CAUTION

 may also result in a vital accident in some situations. In either case, follow these important notes.



These are steps to be taken to ensure proper operation.

RECEIVING

 CAUTION	
	(Ref. page)
<ul style="list-style-type: none">Do not install or operate any inverter which is damaged or has missing parts. Failure to observe this caution may result in personal injury or equipment damage	12

MOUNTING

 CAUTION	
	(Ref. page)
<ul style="list-style-type: none"> • Lift the inverter by the cooling fin. When moving the unit, never lift by the plastic case or the terminal covers. Failure to observe this caution may cause the unit to be dropped resulting in damage to the unit. 13 • Mount the inverter on nonflammable material (i.e., metal). Failure to observe this caution can result in a fire. 13 • When mounting open chassis in an enclosure, install a fan or other cooling device to keep the intake air temperature below 122°F (50°C). Overheating may cause a fire or damage to the unit. 35 • The VS mini J7 generates heat. For effective cooling, mount it vertically. Refer to the figure in “Mounting Dimensions” on page 16. 	

WIRING

 WARNING	
	(Ref. page)
<ul style="list-style-type: none"> • Start wiring only after verifying that the power supply is turned OFF for at least one minute, and all LED’s and change LED’s are extinguished. Failure to observe this warning can result in electric shock or fire. 39 • Wiring should be performed only by qualified personnel. Failure to observe this warning can result in electric shock or fire. 39 • When wiring the emergency stop circuit, check the wiring thoroughly before operation. Failure to observe this warning can result in personal injury. 39 	

 **WARNING**

(Ref. page)

- For 400V class, make sure to ground the supply neutral.
- Make sure to ground the ground terminal  according to the local ground code.
Failure to observe this warning can result in electric shock or fire. 39

 **CAUTION**

(Ref. page)

- Verify that the inverter rated voltage coincides with the AC power supply voltage.
Failure to observe this caution can result in personal injury or fire.
- Do not perform a withstand voltage test of the inverter.
It may cause semi-conductor elements to be damaged.
- Make sure to tighten terminal screws of the main circuit and the control circuit.
Failure to observe this caution can result in a malfunction, damage or a fire. 42
- Never connect the AC main circuit power supply to output terminals U, V and W.
The inverter will be damaged and void the warranty. 42
- Do not connect or disconnect wires or connectors while power is applied to the circuit.
Failure to observe this caution can result in personal injury.
- Do not change signal/control wiring during operation.
The machine or the inverter may be damaged.

OPERATION

 **WARNING**

(Ref. page)

- Only turn ON the input power supply after replacing the digital operator or optional blank cover.
Do not remove the digital operator or the covers while current is flowing.
Failure to observe this warning can result in electric shock.
- Never operate the digital operator or dip switches when your hand is wet.
Failure to observe this warning can result in electric shock.
- Never touch the terminals while current is flowing, even when the inverter is stopped.
Failure to observe this warning can result in electric shock.
- When the fault retry function is selected, stand clear of the inverter or the load. It may restart unexpectedly after being stopped.
(Construct machine system, so as to assure safety for personnel, even if the inverter should restart.) Failure to observe this warning can result in personal injury..... 75
- When continuous operation after power recovery is selected, stand clear of the inverter or the load. It may restart unexpectedly after being stopped.
(Construct machine system, so as to assure safety for personnel, even if the inverter should restart.) Failure to observe this warning can result in personal injury..... 70
- Since the digital operator stop button can be disabled by a parameter setting, install a separate external emergency stop switch.
Failure to observe this warning can result in personal injury.
- If an alarm is reset with the operation signal ON, the inverter restarts automatically. Only reset the alarm after verifying that the operation signal is OFF.
Failure to observe this warning can result in personal injury. 46

 CAUTION

(Ref. page)

- Never touch the heatsink or braking resistor, the temperature is very high.
Failure to observe this caution can result in harmful burns to the body.
- Since it is easy to change operation speed from low to high speed, verify the safe working range of the motor and machine before operation.
Failure to observe this caution can result in personal injury and machine damage.
- Install a holding brake separately if necessary.
Failure to observe this caution can result in personal injury.
- Do not change signals during operation.
The machine or the inverter may be damaged.
- All the parameters of the inverter have been preset at the factory. Do not change the settings unnecessarily.
The inverter may be damaged. 25

MAINTENANCE AND INSPECTION

 WARNING

(Ref. page)

- Never touch high-voltage terminals in the inverter.
Failure to observe this warning can result in an electrical shock. 99
- Disconnect all power before performing maintenance or inspection. Then wait at least one minute after the power supply is disconnected and all LEDs and CHARGE LED are extinguished.
The capacitors discharge slowly, and may be dangerous. 99

 WARNING	
	(Ref. page)
<ul style="list-style-type: none"> • Do not perform a voltage withstand test on any part of the VS mini J7. This electronic equipment uses semiconductors and it is vulnerable to high voltage. 99 • Only authorized personnel should perform maintenance, inspections or parts replacement. [Remove all metal objects (watches, bracelets, etc.) before operation.] (Use tools which are insulated against electrical shock.) Failure to observe this warning can result in an electrical shock. 99 	

 CAUTION	
	(Ref. page)
<ul style="list-style-type: none"> • The control PC board employs CMOS ICs. Do not touch the CMOS elements. They are easily damaged by static electricity. • Do not connect or disconnect wires, digital operator, connectors, or cooling fan while power is applied to the circuit. Failure to observe this caution can result in personal injury. 99 	

Others

 WARNING	
	(Ref. page)
<ul style="list-style-type: none"> • Never modify the product. Failure to observe this warning can result in an electrical shock or personal injury and will void the warranty. 	

WARNING LABEL

A warning label is displayed on the front cover of the inverter, as shown below. Follow these instructions when handling the inverter.

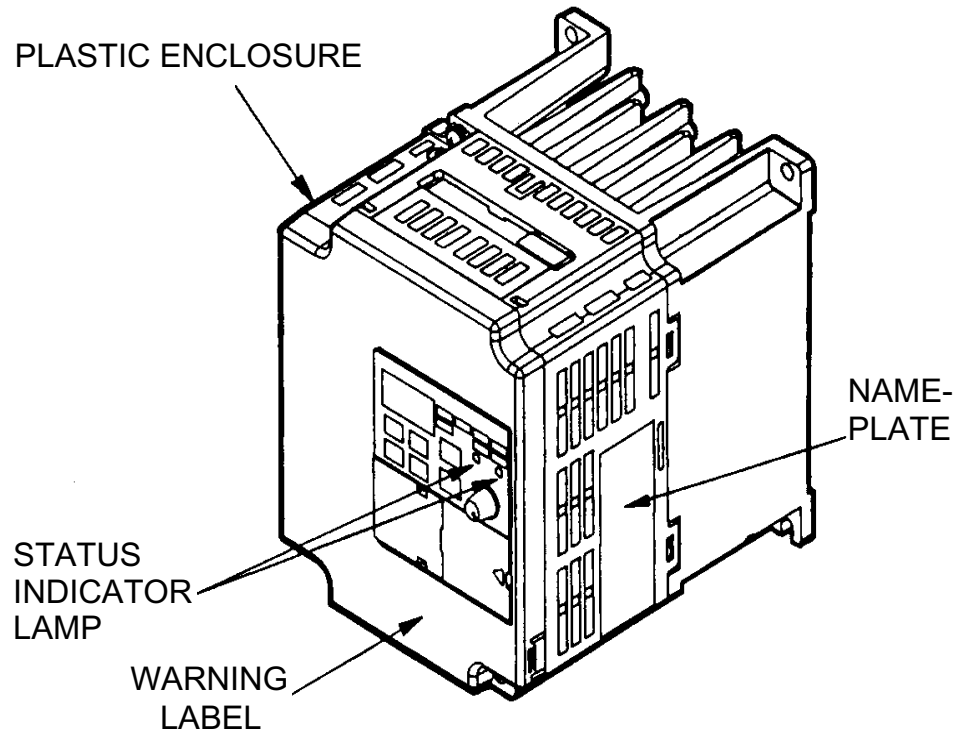

Warning Label

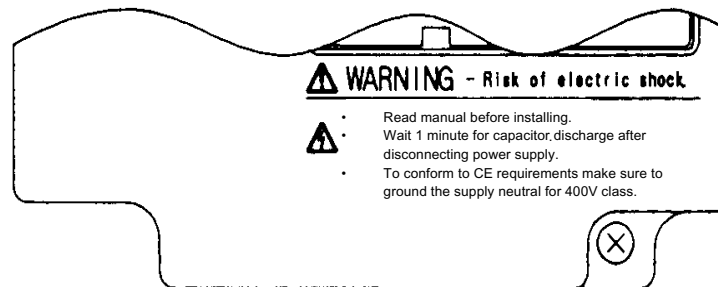

Example of 200V class, 3-phase, 1.5kW inverter

1. RECEIVING

After unpacking the VS mini J7, check the following:

- Verify that the part numbers match your purchase order or packing slip.
- Check the unit for physical damage that may have occurred during shipping.

If any part of VS mini J7 is missing or damaged, call for service immediately.

• Checking the Nameplate

U.S. and Canadian Safety Standards for Types of 3-phase, 200VAC, 0.13HP (0.1kW)

Example of 3-phase, 220VAC, 0.13 (0.1kW)

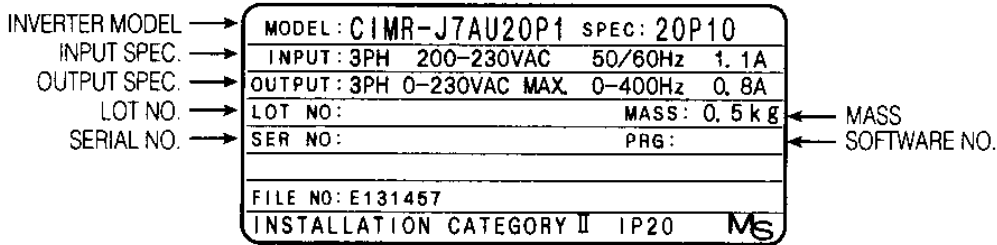

MODEL

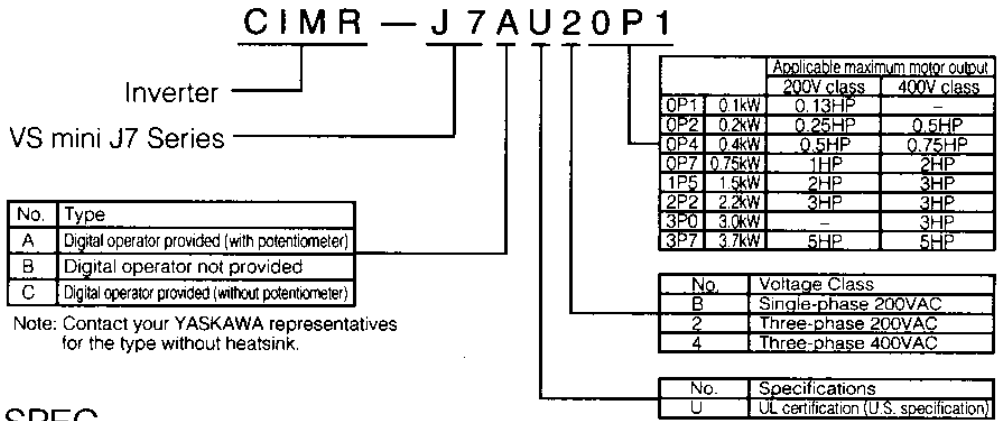

SPEC

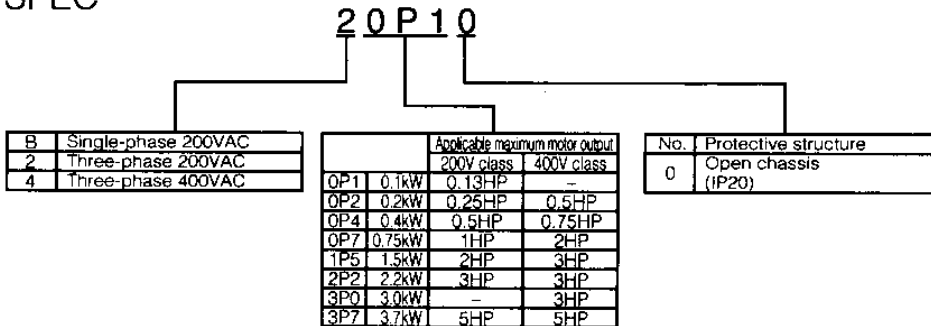

2. IDENTIFYING THE PARTS

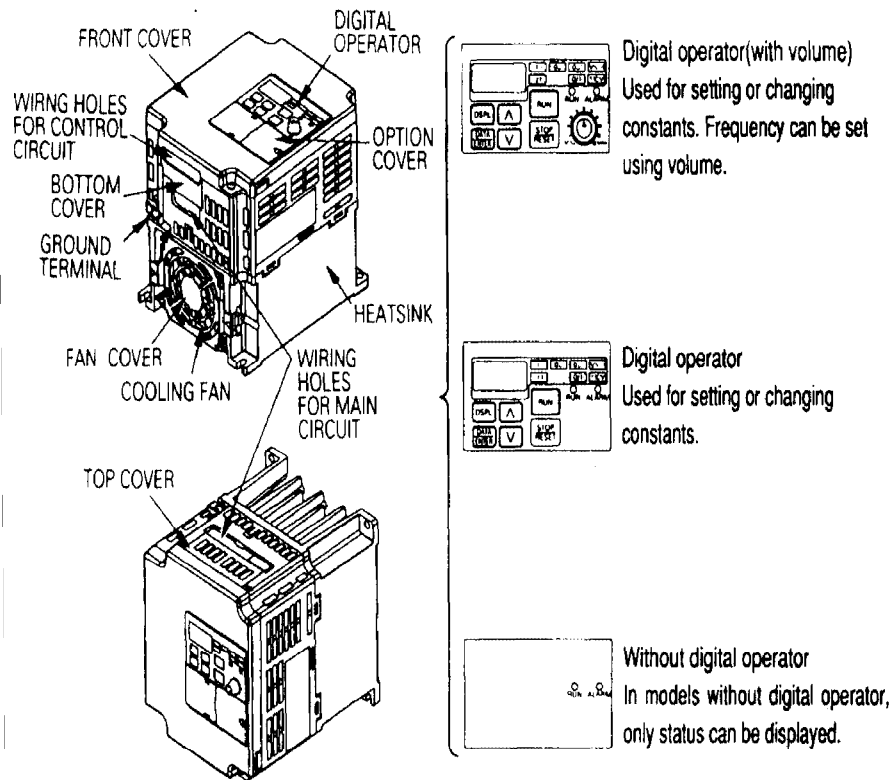

↓ Opening the covers

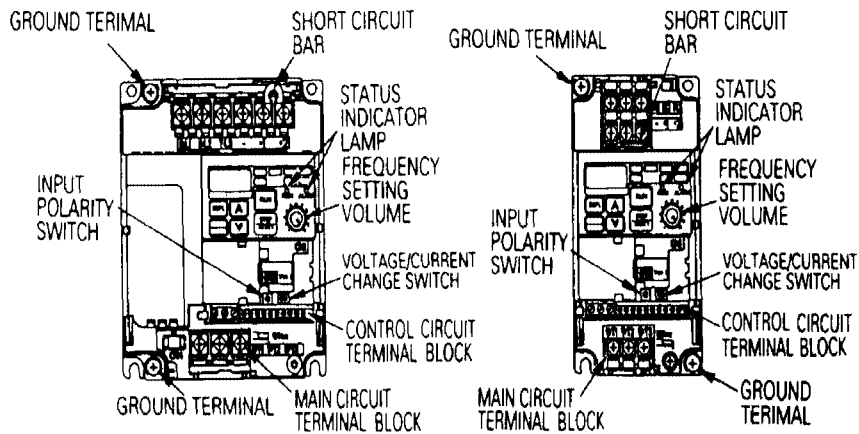

CIMR-J7**21P5, 22P2,
B0P7, B1P5

CIMR-J7**20P1, 20P2, 20P4, 20P7,
B0P1, B0P2, B0P4

Notes

3. Specifications

• Standard Specifications (200V Class)

Voltage Class		200V single- / 3-phase						
Model	3-phase	20P1	20P2	20P4	20P7	21P5	22P2	23P7
CIMR-J7AU□□□□	Single-phase	B0P1	B0P2	B0P4	B0P7	B1P5	-	-
Max. Applicable Motor Output HP (kW)†		0.13 (0.1)	0.25 (0.2)	0.5 (0.4)	1 (0.75)	2 (1.5)	3 (2.2)	5 (3.7)
Output Characteristics	Inverter Capacity (kVA)	0.3	0.6	1.1	1.9	3.0	4.2	6.7
	Rated Output Current (A)	0.8	1.6	3	5	8	11	17.5
	Max. Output Voltage (V) (3-phase output only)	3-phase models, 200 to 230V (proportional to input voltage) Single-phase models, 200 to 240V (proportional to input voltage)						
	Max. Output Frequency (Hz)	400 Hz (Programmable)						
Power Supply	Rated Input Voltage and Frequency	3-phase, 200 to 230V, 50/60Hz Single-phase, 200 to 240V, 50/60Hz						
	Allowable Voltage Fluctuation	-15 to +10%						
	Allowable Frequency Fluctuation	±5%						
Control Characteristics	Control Method	Sine wave PWM (V/f control)						
	Frequency Control Range	0.1 to 400Hz						
	Frequency Accuracy (Temperature Change)	Digital reference: ±0.01% (-10 to +50°C) Analog reference: ±0.5% (25±10°C)						
	Frequency Setting Resolution	Digital reference: 0.1Hz (less than 100Hz) / 1Hz (100Hz or more) Analog reference: 1 / 1000 of max. output frequency						
	Output Frequency Resolution	0.01Hz						
	Overload Capacity	150% rated output current for one minute						
	Frequency Reference Signal	0 to 10VDC (20kΩ), 4 to 20mA (250Ω), 0 to 20mA (250Ω) Frequency setting volume (Selectable)						
	Accel/Decel Time	0.1 to 999sec. (accel/decel time are independently programmed)						
	Braking Torque	Short-term average deceleration torque‡ 0.13HP, 0.25HP (0.1, 0.25kW): 150% 0.5HP, 1HP (0.55, 1.1kW): 100% 2HP (1.5kW): 50% 3HP (2.2kW) or more: 20% Continuous regenerative torque: Approx. 20%						
	V/f Characteristics	Possible to program any V/f pattern						

† Based on a standard 4-pole motor for max. applicable motor output.

‡ Shows deceleration torque for uncoupled motor decelerating from 60Hz with the shortest possible deceleration time.

Voltage Class		200V single- / 3-phase							
Model	3-phase	20P1	20P2	20P4	20P7	21P5	22P2	23P7	
CIMR-J7AU□□□□	Single-phase	B0P1	B0P2	B0P4	B0P7	B1P5	-	-	
Protective Functions	Motor Overload Protection		Electronic thermal overload relay						
	Instantaneous Overcurrent		Motor coasts to a stop at approx. 200% of inverter rated current						
	Overload		Motor coasts to a stop after 1 minute at 150% of inverter rated output current						
	Overvoltage		Motor coasts to a stop if DC bus voltage exceed 410V						
	Undervoltage		Stops when DC bus voltage is approx. 200V or less (approx. 160V or less for single-phase series)						
	Momentary Power Loss		Following items are selectable: Not provided (stops if power loss is 15ms or longer), continuous operation if power loss is approx. 0.5s or shorter, continuous operation						
	Cooling Fin Overheat		Protected by electronic circuit						
	Stall Prevention Level		Individual levels during accel/running, enable/disable provided during deceleration						
	Cooling Fan Fault		Protected by electronic circuit (fan stalling detection)						
	Ground Fault		Protected by electronic circuit (rated output current level)						
Other Functions	Power Charge Indication		RUN lamp stays ON or digital operator LED stays ON. (Charge LED is provided for 400V) ON until the DC bus voltage becomes 50V or less.						
	Input Signals	Multi-function Input	Four of the following input signals are selectable: Reverse run (3-wire sequence), fault reset, external fault (NO/NC contact input), multi-step speed operation, Jog command, accel/decel time select, external baseblock (NO/NC contact input), speed search command, accel/decel hold command, LOCAL/REMOTE selection, communication/control circuit terminal selection, emergency stop fault emergency stop alarm						
	Output Signals	Multi-function Output	Following output signals are selectable (1 NO/NC contact output): Fault, running, zero speed, at frequency, frequency detection (output frequency \leq or \geq set value), during over torque detection, minor error, during baseblock, operation mode, inverter run ready, during fault retry, during UV, during speed search, during speed search, data output through communication						
	Standard Functions		Full-range automatic torque boost, slip compensation, DC injection braking current/time at start/stop frequency reference bias/gain, [MEMOBUS communications (RS-485/422, max. 19.2K bps).]						

Voltage Class		200V single- / 3-phase						
Model CIMR-J7AU□□□□	3-phase	20P1	20P2	20P4	20P7	21P5	22P2	23P7
	Single-phase	B0P1	B0P2	B0P4	B0P7	B1P5	-	-
Other Functions	Display	Status Indicator LED	RUN and ALARM provided as standard LED's					
		Digital Operator (JVOP-140)	Available to monitor frequency reference, output frequency, output current. 3 character, 7 segment LED Display.					
	Terminals		Main circuit: screw terminals Control circuit: plug-in screw terminal					
	Wiring Distance between Inverter and Motor		328ft (100m) or less‡					
Enclosure		Open chassis						
Cooling Method		Cooling fan is provided for 200V, 0.75kW (3-phase), 400V, 1.5kW (single-phase), others are self-cooling						
Environmental Conditions	Ambient Temperature		Open chassis: -10 to +50°C (14 to 122°F) (not frozen)					
	Humidity		95% RH or less (non-condensing)					
	Storage Temperature†		-4 to 140°F (-20 to +60°C)					
	Location		Indoor (free from corrosive gases or dust)					
	Elevation		3280ft (1000m) or less					
	Vibration		Up to 9.8m / S ² (1G) at less than 20Hz, up to 2m / S ² (0.2G) at less than 20 to 50Hz					

†Temperature during shipping (for short period)

‡ If the wiring distance between inverter and motor is long, reduce the inverter carrier frequency.
For details, refer to “Reducing motor noise or leakage current (n46)” on page 79.

• Standard Specifications (400V Class)

Voltage Class		400V 3-phase					
Model CIMR-J7A□□□□	3-phase	40P2	40P4	40P7	41P5	42P2	43P7
Max. Applicable Motor Output HP (kW)*		0.25 (0.2)	0.5 (0.4)	1 (0.75)	2 (1.5)	3 (2.2)	5 (3.7)
Output Characteristics	Inverter Capacity (kVA)	0.9	1.4	2.6	3.7	4.2	6.5
	Rated Output Current (A)	1.2	1.8	3.4	4.8	5.5	8.6
	Max. Output Voltage (V)	3-phase, 380 to 460V (proportional to input voltage)					
	Max. Output Frequency (Hz)	400 Hz (Programmable)					
Power Supply	Rated Input Voltage and Frequency	3-phase, 380 to 460V, 50/60Hz					
	Allowable Voltage Fluctuation	-15 to +10%					
	Allowable Frequency Fluctuation	±5%					
Control Characteristics	Control Method	Sine wave PWM (V/f control)					
	Frequency Control Range	0.1 to 400Hz					
	Frequency Accuracy (Temperature Change)	Digital reference: ±0.01%, 14 to 122°F (-10 to +50°C) Analog reference: ±0.5%, 59 to 95°F (25 ±10°C)					
	Frequency Setting Resolution	Digital reference: 0.1Hz (less than 100Hz) / 1Hz (100Hz or more) Analog reference: 1 / 1000 of max. output frequency					
	Output Frequency Resolution	0.01Hz					
	Overload Capacity	150% rated output current for one minute					
	Frequency Reference Signal	0 to 10VDC (20kΩ), 4 to 20mA (250Ω), 0 to 20mA (250Ω) Frequency setting volume (Selectable)					
	Accel/Decel Time	0.1 to 999 sec. (accel/decel time are independently programmed)					
	Braking Torque	Short-term average deceleration torque† 0.2kW: 150% 0.75kW: 100% 2HP (1.5kW): 50% 3HP (2.2kW) or more: 20% Continuous regenerative torque: Approx. 20%					
	V/f Characteristics	Possible to program any V / f pattern					

* Based on a standard 4-pole motor for max. applicable motor output.

† Shows deceleration torque for uncoupled motor decelerating from 60Hz with the shortest possible deceleration time.

Voltage Class		400V 3-phase					
Model CIMR-J7A□□□□	3-phase	40P2	40P4	40P7	41P5	42P2	43P7
Protective Functions	Motor Overload Protection	Electronic thermal overload relay					
	Instantaneous Over Current	Motor coasts to a stop at approx. 200% of inverter rated current					
	Overload	Motor coasts to a stop after 1 minute at 150% of inverter rated output current					
	Over Voltage	Motor coasts to a stop if DC bus voltage exceed 820V					
	Under Voltage	Stops when DC bus voltage is approx. 400V or less					
	Momentary Power Loss	Following items are selectable: Not provided (stops if power loss is 15ms or longer), continuous operation if power loss is approx. 0.5s or shorter, continuous operation					
	Cooling Fin Overheat	Protected by electronic circuit					
	Stall Prevention Level	Individual levels during accel/running, enable/disable provided during deceleration.					
	Cooling Fan Fault	Protected by electronic circuit (fan stalling detection)					
	Ground Fault	Protected by electronic circuit (rated output current level)					
Other Functions	Power Charge Indication	Charge LED is provided On until the DC bus voltage becomes 50V or less.					
	Input Signals	Multi-function Input	Four of the following input signals are selectable: Reverse run (3-wire sequence), fault reset, external fault (NO/NC contact input), multi-step speed operation, Jog command, accel/decel time select, external baseblock (NO/NC contact input), speed search command, accel/decel hold command, LOCAL/REMOTE selection, communication/control circuit terminal selection, emergency stop fault, emergency stop alarm				
	Output Signals	Multi-function Output	Following output signals are selectable (1 NO/NC contact output.): Fault, running, zero speed, at frequency, frequency detection (output frequency \leq or \geq set value), during over torque detection, during under voltage detection, minor error, during baseblock, operation mode, inverter run ready, during fault retry, during UV, during speed search, data output through communication				
	Standard Functions		Full-range automatic torque boost, slip compensation, DC injection braking current/time at start/stop frequency reference bias/gain, frequency reference with built-in volume, [MEMOBUS communications (RS-485/422, max. 19.2K).]				

Voltage Class		400V 3-phase					
Model CIMR-J7A□□□□	3-phase	40P2	40P4	40P7	41P5	42P2	43P7
Other Functions	Display	Status Indicator LED	RUN and ALARM provided as standard LEDs				
		Digital Operator	Available to monitor frequency reference, output frequency, output current. 3 character, 7 segment LED display.				
	Terminals		Main circuit: screw terminals Control circuit: plug-in screw terminal				
	Wiring Distance between Inverter and Motor		328ft (100m) or less†				
Enclosure		Open chassis or enclosed wall-mounted					
Cooling Method		Cooling fan is provided for 200V, 0.75kW (3-/single phase), 200V, 0.75kW (1.5HP), others are self-cooling					
Environmental Conditions	Ambient Temperature		Open chassis: -10 to +50°C (14 to 122°F) (not frozen)				
	Humidity		95% RH or less (non-condensing)				
	Storage Temperature*		-20 to 60°F (-4 to +140°C)				
	Location		Indoor (free from corrosive gases or dust)				
	Elevation		3280ft (1000m) or less				
	Vibration		Up to 9.8m / S ² (1G) at less than 20Hz, up to 2m / S ² (0.2G) at less than 20 to 50Hz				

* Temperature during shipping (for short period)

† If the wiring distance between inverter and motor is long, reduce the inverter carrier frequency.

For details, refer to “Reducing motor noise or leakage current (n46)” on page 79.

- **Standard Wiring**

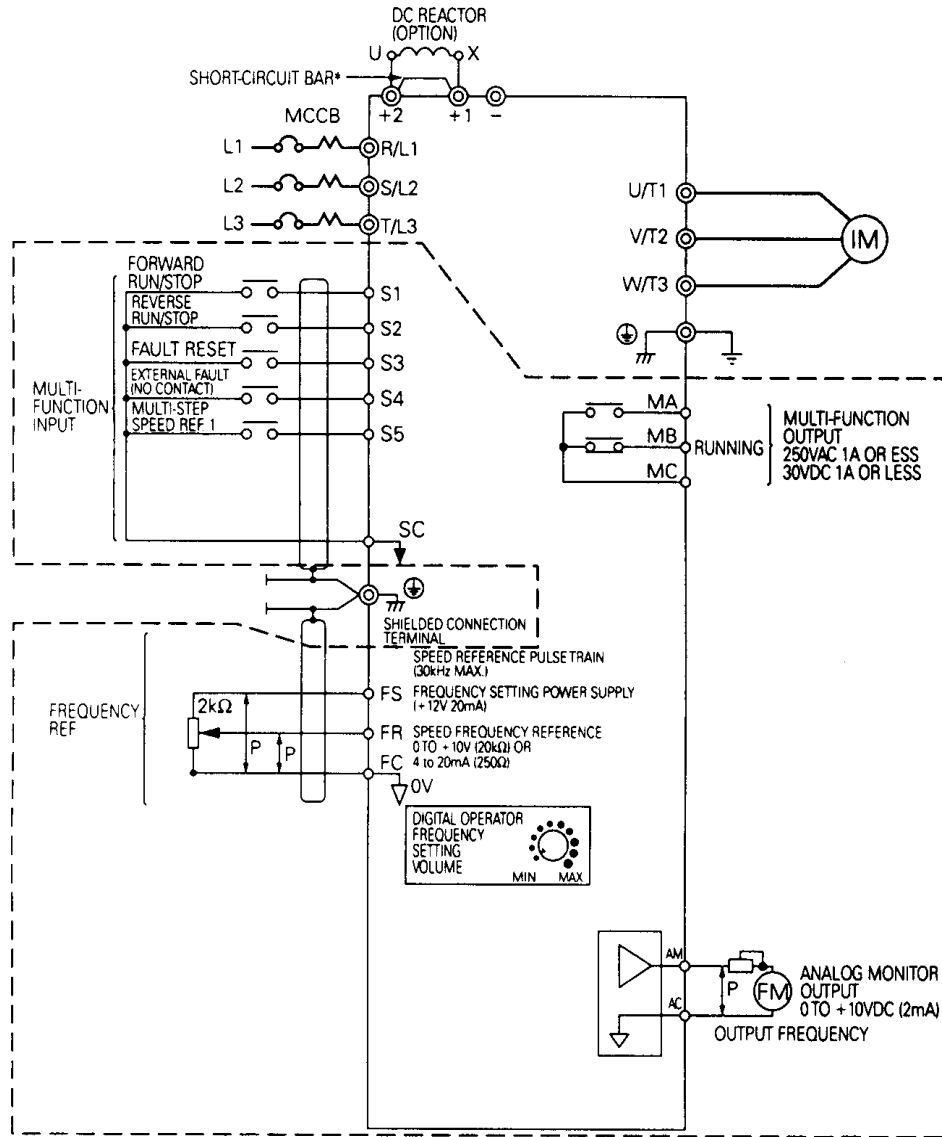

Shielded

Twisted-pair wires

: Only basic insulation is provided for the control circuit terminals. Additional insulation may be necessary in the end product.

* Short-circuit bar should be removed when connecting DC reactor.

Terminal Description

Type	Terminal	Name	Function (Signal Level)			
Main Circuit	R/L1, S/L2, T/L3	AC power supply input	Use main circuit power input (for single-phase inverter, R/L1, S/L2). Even though T/L3 is available, do not use the terminal for other purposes such as relay terminal.			
	U/T1, V/T2, W/T3	Inverter output	Inverter output			
	+2, +1	DC reactor connection	When connecting optional DC reactor, remove the main circuit short-circuit bar between +2 and +1.			
	+1, (-)	DC power supply input	DC power supply input (+1: positive, -: negative) *			
		Grounding	Grounding 200V: grounding to 100Ω or less 400V: grounding to 10Ω or less			
Control Circuit	Input	Sequence	S1	Forward run input	Closed: FWD run	Photo-coupler insulation 24VDC, 8mA.
			S2	Multi-function input selection 2	Factory setting closed: REV run	
			S3	Multi-function input selection 3	Factory setting: Fault reset	
			S4	Multi-function input selection 4	Factory setting: External fault (N.O. contact)	
			S5	Multi-function input selection 5	Factory setting: Multi-step speed reference 1	
			SC	Multi-function input selection common	Control signal common	
	Frequency reference	FS	Power for frequency setting	+12V (permissible current 20mA max.)		
		FR	Master speed frequency reference	0 to +10DC (20kΩ) or 4 to 20mA (250Ω) or 20mA (250Ω) (1/1000 resolution)		
		FC	Frequency reference common	0V		
	Output	Multi-function contact output	MA	NO contact output	Form C contact Factory setting: running	Contact capability 250VAC 1A or less, 30VDC 1A or less
			MB	NC contact output		
			MC	Contact output common		
		AM	Analog monitor output	Factory setting: Output frequency 0 to +10VDC	0 to +10VDC, 2mA or less, 8-bit resolution	
		AC	Analog monitor common	0V		

* DC power supply input terminal is not available on CE/UL standards.

- **Dimensions**

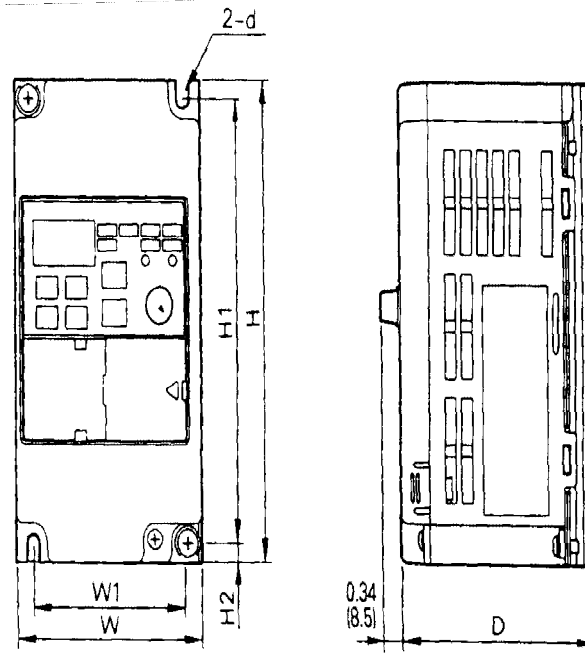

Fig. 1

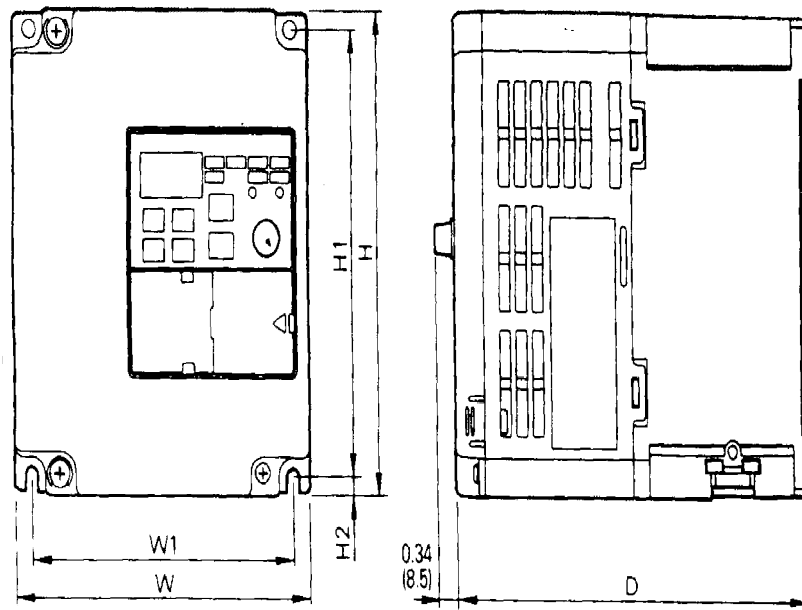

Fig. 2

Dimensions in inches (mm)/mass in lb (kg)

Voltage class	Capacity HP (kW)	W	H	D	W1	H1	H2	d	Mass	Fig.
200V 3-phase	0.13 (0.1)	2.68 (68)	5.04 (128)	2.76 (70)	2.20 (56)	4.65 (118)	0.20 (5)	M 4	1.32 (0.6)	1
	0.25 (0.2)	2.68 (68)	5.04 (128)	2.76 (70)	2.20 (56)	4.65 (118)	0.20 (5)	M 4	1.32 (0.6)	1
	0.5 (0.4)	2.68 (68)	5.04 (128)	4.02(102)	2.20 (56)	4.65 (118)	0.20 (5)	M 4	1.98 (0.9)	1
	1 (0.75)	2.68 (68)	5.04 (128)	4.80(122)	2.20 (56)	4.65 (118)	0.20 (5)	M 4	2.43 (1.1)	1
	2 (1.5)	4.25 (108)	5.04 (128)	5.08 (129)	3.78 (96)	4.65 (118)	0.20 (5)	M 4	3.09 (1.4)	2
	3 (2.2)	4.25 (108)	5.04 (128)	6.06 (154)	3.78 (96)	4.65 (118)	0.20 (5)	M 4	3.31 (1.5)	2
200V single-phase	0.13 (0.1)	2.68 (68)	5.04 (128)	2.76 (70)	2.20 (56)	4.65 (118)	0.20 (5)	M 4	1.32 (0.6)	1
	0.25 (0.2)	2.68 (68)	5.04 (128)	2.76 (70)	2.20 (56)	4.65 (118)	0.20 (5)	M 4	1.54 (0.7)	1
	0.5 (0.4)	2.68 (68)	5.04 (128)	4.41 (112)	2.20 (56)	4.65 (118)	0.20 (5)	M 4	2.20 (1.0)	1
	1 (0.75)	4.25 (108)	5.04 (128)	5.08 (129)	3.78 (96)	4.65 (118)	0.20 (5)	M 4	3.31 (1.5)	2
	2 (1.5)	4.25 (108)	5.04 (128)	6.06 (154)	3.78 (96)	4.65 (118)	0.20 (5)	M 4	3.31 (1.5)	2
400V 3-phase	0.25 (0.2)	4.25 (108)	5.04 (128)	3.19 (81)	3.78 (96)	4.65 (118)	0.20 (5)	M 4	2.20 (1.0)	2
	0.5 (0.4)	4.25 (108)	5.04 (128)	3.90 (99)	3.78 (96)	4.65 (118)	0.20 (5)	M 4	2.43 (1.1)	2
	1 (0.75)	4.25 (108)	5.04 (128)	5.08 (129)	3.78 (96)	4.65 (118)	0.20 (5)	M 4	3.31 (1.5)	2
	2 (1.5)	4.25 (108)	5.04 (128)	6.06 (154)	3.78 (96)	4.65 (118)	0.20 (5)	M 4	3.31 (1.5)	2
	3 (2.2)	4.25 (108)	5.04 (128)	6.06 (154)	3.78 (96)	4.65 (118)	0.20 (5)	M 4	3.31 (1.5)	2
	5 (3.7)	5.51 (140)	5.04 (128)	6.34 (161)	5.04(128)	4.65 (118)	0.20 (5)	M 4	4.63 (2.1)	2

• Parameters List

First Functions (Parameters n001 to n049)

No.	Register No. for Transmission	Name	Description	Initial Setting	*User Setting	Ref. Page
01	0101H	Parameter write-in prohibit / initialize	0: Parameter n001 set / read and parameter n02 ~ n79 can be read. (FREF of the operator can be set.) 1: Functions (parameters n01 ~ n79) can be set / read. 6: Clear fault history 8: 2 wire initialize (Japanese Specification) 9: 3 wire initialize (Japanese Specification) 10: 2 wire initialize (American Specification) 11: 3 wire initialize (American Specification)	1		57
02	0102H	Operation reference selection	0: Operator 1: Control circuit terminal 2: Communication	1		62
03	0103H	Frequency reference selection	0: Volume 1: Frequency reference 1 (n21) 2: Control circuit terminal (voltage 0 ~ 10V) 3: Control circuit terminal (current 4 - 20 mA) 4: Control circuit terminal (current 0 - 20 mA) 5: Not used (setting error) 6: Communication (register number 0002H)	2		63
04	0104H	Stopping method selection	0: Decel to stop 1: Coast to stop	0		82
05	0105H	REV run prohibit	0: Reverse run enabled 1: Reverser run disabled	0		65
06	0106H	Operation stop key selection	0: Stop key enabled 1: Stop key is enabled only when run command is selected to the operator.	0		81
07	0107H	Frequency reference selection in local mode	0: Volume 1: Frequency reference selection (n21)	0 (Note4)		63
08	0108H	Setting method selection for frequency reference	0: Frequency reference setting by the operator is enabled with the ENTER key input 1: Frequency reference setting by the operator is not required the ENTER key input.	0		63

No.	Register No. for Transmission	Name	Description	Initial Setting	*User Setting	Ref. Page
09	0109H	Maximum output frequency	Setting unit: 0.1Hz (less than 100Hz) / 1Hz (100Hz or greater) Setting range: 50.0 ~ 400Hz	60.0Hz		58
10	010AH	Maximum voltage	Setting unit: 1V Setting range: 1 ~ 255V	230V (Note 1)		58
11	010BH	Maximum voltage output frequency	Setting unit: 0.1Hz (less than 100Hz) / 1Hz (100Hz or greater) Setting range: 0.2 ~ 400Hz	60.0Hz		58
12	010CH	Mid. output frequency	Setting unit: 0.1Hz (less than 100Hz) / 1Hz (100Hz or greater) Setting range: 0.1 ~ 399Hz	1.5Hz		58
13	010DH	Mid. output frequency	Setting unit: 1V Setting range: 1 - 255V	12V (Note1)		58
14	010EH	Minimum output frequency	Setting unit: 0.1Hz Setting range: 0.1 ~ 10.0Hz	1.5Hz		58
15	010FH	Mid. output frequency voltage	Setting unit: 1V Setting range: 1 ~ 50V	12V (Note1)		58
16	0110H	Acceleration time 1	Setting unit: 0.1s (less than 100s) / 1s (100s or greater) Setting range: 0.0 ~ 999s	10.0s		69
17	0111H	Deceleration time 1	Setting unit: 0.1s (less than 100s) / 1s (100s or greater) Setting range: 0.0 ~ 999s	10.0s		69
18	0112H	Acceleration time 2	Setting unit: 0.1s (less than 100s) / 1s (100s or greater) Setting range: 0.0 ~ 999s	10.0s		69
19	0113H	Deceleration time 2	Setting unit: 0.1s (less than 100s) / 1s (100s or greater) Setting range: 0.0 ~ 999s	10.0s		69
20	0114H	S-curve accel / decel selection	0: No S-curves 1: 0.2s 2: 0.5s 3: 1.0s	0		72
21	0115H	Frequency reference 1 (Master speed frequency reference)	Setting unit: 0.1Hz (less than 100Hz) / 1Hz (100Hz or greater) Setting range: 0.0 ~ 400Hz	0.0Hz		65
22	0116H	Frequency reference 2	Setting unit: 0.1Hz (less than 100Hz) / 1Hz (100Hz or greater) Setting range: 0.0 ~ 400Hz	0.0Hz		65
23	0117H	Frequency reference 3	Setting unit: 0.1Hz (less than 100Hz) / 1Hz (100Hz or greater) Setting range: 0.0 ~ 400Hz	0.0Hz		65

No.	Register No. for Transmission	Name	Description	Initial Setting	*User Setting	Ref. Page
24	0118H	Frequency reference 4	Setting unit: 0.1Hz (less than 100Hz) / 1Hz (100Hz or greater) Setting range: 0.0 ~ 400Hz	0.0Hz		65
25	0119H	Frequency reference 5	Setting unit: 0.1Hz (less than 100Hz) / 1Hz (100Hz or greater) Setting range: 0.0 ~ 400Hz	0.0Hz		65
26	011AH	Frequency reference 6	Setting unit: 0.1Hz (less than 100Hz) / 1Hz (100Hz or greater) Setting range: 0.0 ~ 400Hz	0.0Hz		65
27	011BH	Frequency reference 7	Setting unit: 0.1Hz (less than 100Hz) / 1Hz (100Hz or greater) Setting range: 0.0 ~ 400Hz	0.0Hz		65
28	011CH	Frequency reference 8	Setting unit: 0.1Hz (less than 100Hz) / 1Hz (100Hz or greater) Setting range: 0.0 ~ 400Hz	0.0Hz		65
29	011DH	Jog frequency reference	Setting unit: 0.1Hz (less than 100Hz) / 1Hz (100Hz or greater) Setting range: 0.0 ~ 400Hz	6.00Hz		66
30	011EH	Frequency reference upper limit	Setting unit: 1% Setting range: 0 ~ 110%	100%		69
31	011FH	Frequency reference lower limit	Setting unit: 1% Setting range: 0 ~ 110%	0%		69
32	0120H	Motor rated current	Setting unit: 0.1A Setting range: 0 ~ 120% of inverter rated output current Note: if set to 0%, then electronic thermal motor overload is disabled.	(Note 2)		94
33	0121H	Electronic thermal motor protection	0: Standard motor application 1: Specialized motor application 2: No electronic motor overload protection	0		94

No.	Register No. for Transmission	Name	Description	Initial Setting	*User Setting	Ref. Page
34	0122H	Parameter selection at electronic thermal motor protection	Setting unit: 1min Setting range: 1 ~ 60min	8 min		94
35	0123H	Cooling fan operation selection	0: Controls the cooling fan OFF / ON 1: Operates when power is ON.	0		96
36	0124H	Multi-function input selection 2	1: Not used 2: Reverse run reference (2 wire sequence) 3: External fault (N. O. contact input) 4: External fault (N. C. contact input) 5: Fault reset 6: Multi speed reference 1 8: Multi speed reference 2 7: Multi speed reference 3 9: Not used 10: Jog reference 11: Accel / decel time switching reference 12: External baseblock reference (N. O. contact input) 13: External baseblock reference (N. C. contact input) 14: Speed search command from Max. output frequency 15: Speed search command set frequency 16: Accel / decel hold 17: Local / remote switching 18: Communication / control circuit terminal switching 19: Emergency stop fault (N. O. contact input) 20: Emergency stop alarm (N. O. contact input) 21: Emergency stop fault (N. C. contact input) 22: Emergency stop alarm (N. C. contact input) 23~ 33: Unused	2		82
37	0125H	Multi-function input selection 3	0: Forward / reverse command (3 wire sequence) Others are the same as parameter 36	5		84
38	0126H	Multi-function input selection 4	Same as parameter 36	3		84
39	0127H	Multi-function input selection 5	Same as parameter 36 34: Up/down reference 35: Self-test (Note: valid power ON / OFF)	6		84

No.	Register No. for Transmission	Name	Description	Initial Setting	*User Setting	Ref. Page
40	0128H	Multi-function output selection	0: Fault 1: During run 2: Frequency agree 3: During zero speed 4: Frequency detection (detection level or greater) 5: Frequency detection (detection level or less) 6: During over torque detection (N. O. contact output) 7: During over torque detection (N. C. contact output) 8: Not used 9: Not used 10: Minor fault (during warning display) 11: During baseblock 12: Run mode 13: Inverter ready 14: During fault retry 15: During UV 16: During reverse run 17: During speed search 18: Data output through communication	1		87
41	0129H	Analog frequency reference gain	Setting unit: 1% Setting range: 0 - 255%	100%		67
42	012AH	Analog frequency reference bias	Setting unit: 1% Setting range: -99 ~ 99%	0%		67
43	012BH	Analog frequency reference filter time parameter	Setting unit: 0.01s Setting range: 0.00 ~ 2.00s (Note) When 0.00s is set, there is no filter	0.10s		-

No.	Register No. for Transmission	Name		Initial Setting	User Setting	Ref. Page
44	012CH	Monitor item selection	0: Output frequency 1: Output current	0		78
45	012DH	Monitor gain	Setting unit: 0.01 Setting range: 0.01 ~ 2.00	1.00		78
46	012EH	Carrier frequency	Set value: 1 ~ 4 carrier frequency = set value \times 2.5kHz Set value: Synchronous type of 7 ~ 9 lower limit 1kHz and upper limit 2.5 kHz	4(Note 3)		79
47	012FH	Operation selection after momentary power loss	0: Operation does not continue. 1: Operation continues within momentary power ride through time 2: Operation always continues. (No UV1 fault detection)	0		70
48	0130H	Fault reset	Setting unit: time Setting range: 0 ~ 10 times	0 time		75
49	0131H	Jump frequency 1	Setting unit: 0.1Hz (less than 100Hz) / 1Hz (100Hz or greater) Setting range: 0.00 ~ 400Hz (Note) If 0.0Hz is set, jump frequency 1 is enabled.	0.0Hz		75
50	0132H	Jump frequency 2	Setting unit: 0.1Hz (less than 100Hz) / 1Hz (100Hz or greater) Setting range: 0.00 ~ 400Hz (Note) If 0.0Hz is set, jump frequency 2 is disabled.	0.0Hz		75
51	0133H	Jump frequency width	Setting unit: 0.1Hz Setting range: 0.0 ~ 25.5Hz (Note) If 0.0Hz is set, jump frequencies 1 ~ 2 are disabled.	0.0Hz		75
52	0134H	DC injection braking current	Setting unit: 1% Setting range: 0 ~ 100% (note) If 0% is set, it becomes base-block status.	50%		76
53	0135H	DC injection braking time at stop	Setting unit: 0.1s Setting range: 0.0 ~ 25.5s (Note) If 0.0s is set, this function will not operate.	0.0s		83
54	0136H	DC injection braking time at start	Setting unit: 0.1s Setting range: 0.0 ~ 25.5s (Note) If 0.0s is set, this function will not operate.	0.0s		76
55	0137H	Stall prevention (current limit) during decel	0: Stall prevention function is enabled during deceleration. 1: Stall prevention function is disabled during deceleration.	0		92
56	0138H	Stall prevention (current limit) during accel	Setting unit: 1% Setting range: 30 ~ 200% (Note): If set at 200%, this function will not operate. (Note): For rated output range, the operator level is automatically reduced.	170%		91

No.	Register No. for Transmission	Name		Initial Setting	User Setting	Ref. Page
57	0139H	Stall prevention (current limit) during running	Setting unit: 1% Setting range: 30 ~ 200% (Note): If set at 200%, this function will not operate.	160%		92
58	013AH	Frequency detection level	Setting unit: 0.1Hz (less than 100Hz) / 1Hz (100Hz or greater) Setting range: 0.00 ~ 400Hz	0.0Hz		74
59	013BH	Overtorque detection	0: Overtorque detection disabled. 1: Detects only at speed agree, operation continues after detection. 2: Detects only at speed agree, output is shut down after detection. 3: Detects during run, operation continued after detection. 4: Detects during run, output is shut down after detection.	0		73
60	013CH	Overtorque detection level	Setting unit: 1% Setting range: 30 ~ 200%	160%		73
61	013DH	Overtorque detection time	Setting unit: 0.1s Setting range: 0.1 ~ 10.0s	0.1s		73
62	013EH	Memory selection of hold output frequency	0: Hold output frequency is not stored. 1: Hold output frequency is stored.	0		86
63	013FH	Torque compensation gain	Setting unit: 0.1 Setting range: 0.0 ~ 2.5	1.0		60
64	0140H	Motor rated slip	Setting unit: 0.1Hz Setting range: 0.0 ~ 20.0Hz	(Note 2)		-
65	0141H	Motor no-load current	Setting unit: 1% Setting range: 0 ~ 99%	(Note 2)		-
66	0142H	Slip compensation gain	Setting unit: 0.1 Setting range: 0.0 ~ 2.5	1.0		93
67	0143H	Slip compensation primary delay time	Setting unit: 0.1s Setting range: 0.0 ~ 25.5s	2.0s		93
68	0144H	Timeover detection selection	0: Timeover detection enabled. (Coast to stop) 1: Timeover detection enabled. (Deceleration stop by deceleration time 1) 2: Timeover detection enabled. (Deceleration stop by deceleration time 2) 3: Timeover detection enabled. (Operation continues, alarm displays) 4: Timeover detection disabled.	0		-
69	0145H	Setting unit selection of communications frequency reference/frequency monitor	0: 0.1Hz / 1 1: 0.01Hz / 1 2: 100% / 30000 3: 0.1% / 1	0		-

No.	Register No. for Transmission	Name		Initial Setting	User Setting	Ref. Page
70	0146H	Slave address	Setting unit: 1 Setting range: 0 ~ 32	0		-
71	0147H	Baud rate selection	0: 2400 bps 1: 4800 bps 2: 9600 bps 3: 19200 bps	2		-
72	0148H	Parity selection	0: Even parity 1: Odd parity 2: No parity	0		-
73	0149H	Send waiting time	Setting unit: 1 = 1ms Setting range: 10 ~ 65 ms	10ms		-
74	014AH	RTS control	0: RTS control enabled. 1: RTS control disabled.	0		-
75			—			
76			0: Execution completed / execution command receive condition 1: READ execute 2: COPY execute 3: VRFY execute 4: kVA display 5: Software No. display			
77			0: READ prohibited. 1: READ allowed.			
78	014EH	Fault history	The 1 newest event is displayed (Note) Setting is disabled.	-		54
79	014FH	Software No.	Lower 3 digits of software numbers are displayed. (Note): Setting is disabled.	-		-

1. Upper limit of setting range and initial setting are doubled at 400 class.
2. Changes depending on inverter capacity. Refer to the next page.
3. Initial setting of the model with digital operator (without volume) is 1.
Setting can be set to 0 by parameter initialization.

• KVA Dependant Parameter Default Settings

200V class 3-phase

No.	Name	Unit	Factory setting							
			0.1kW	0.2kW	0.4kW	0.75kW	1.5kW	2.2kW	–	3.7kW
–	Inverter capacity	kW	0.1kW	0.2kW	0.4kW	0.75kW	1.5kW	2.2kW	–	3.7kW
n32	Motor rated current	A	0.6	1.1	1.9	3.3	6.2	8.5	–	14.1
n64	Motor rated slip	Hz	2.5	2.6	2.9	2.5	2.6	2.9	–	3.3
n65	Motor no-load current	%	72	73	62	55	45	35	–	32

200V class single-phase

No.	Name	Unit	Factory setting							
			0.1kW	0.2kW	0.4kW	0.75kW	1.5kW	2.2kW	–	3.7kW
–	Inverter capacity	kW	0.1kW	0.2kW	0.4kW	0.75kW	1.5kW	2.2kW	–	3.7kW
n32	Motor rated current	A	0.6	1.1	1.9	3.3	6.2	8.5	–	14.1
n64	Motor rated slip	Hz	2.5	2.6	2.9	2.5	2.6	2.9	–	3.3
n65	Motor no-load current	%	72	73	62	55	45	35	–	32

400V class 3-phase

No.	Name	Unit	Factory setting							
			–	0.2kW	0.4kW	0.75kW	1.5kW	2.2kW	–	3.7kW
–	Inverter capacity	kW	–	0.2kW	0.4kW	0.75kW	1.5kW	2.2kW	–	3.7kW
n32	Motor rated current	A	–	0.6	1.0	1.6	3.1	4.2	7.0	7.0
n64	Motor rated slip	Hz	–	2.5	2.7	2.6	2.5	3.0	3.2	3.2
n65	Motor no-load current	%	–	73	63	52	45	35	33	33

Notes

4. MOUNTING

• **Choosing a Location to Mount the Inverter**

Be sure the inverter is protected from the following conditions:

- Extreme cold and heat. Use only within the ambient temperature range (for open chassis type): 14 to 122°F (-10 to +50°C)
- Rain, moisture.
- Oil sprays, splashes.
- Salt spray.
- Direct sunlight. (Avoid using outdoors).
- Corrosive gases (e.g. sulfurized gas) or liquids.
- Dust or metallic particles in the air.
- Physical shock, vibration.
- Magnetic noise. (Example: welding machines, power devices, etc.)
- High humidity.
- Radioactive substances.
- Combustibles: thinner, solvents, etc.

- **Mounting Dimensions**

Clearances as shown below are required when mounting the VS mini.

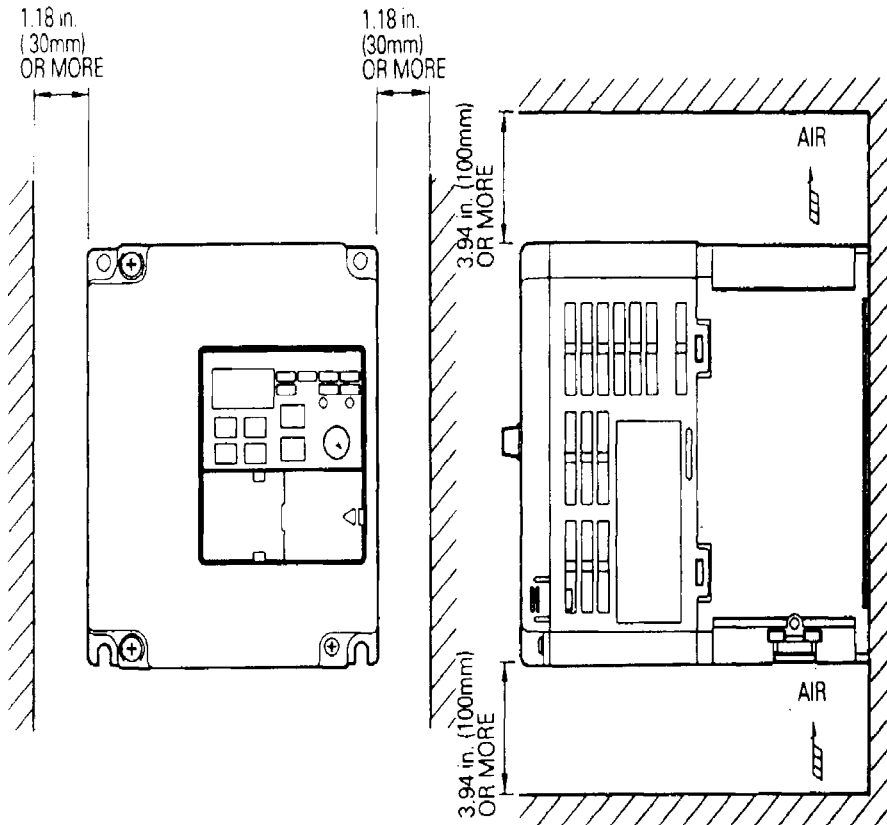

- **Mounting/Removing Components**

- **Removing and Mounting Digital Operator and Covers**

- **Removing front cover**

- Use a screwdriver to loosen the screw on the front cover surface to direction 1 to remove it. Then press the right and left sides to direction 2 and lift the front cover to direction 3.

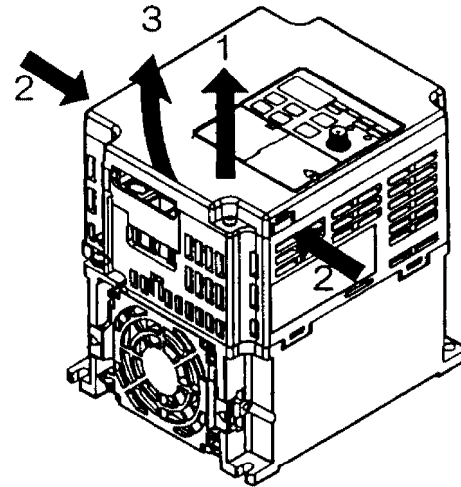

- **Mounting front cover**

- Insert the tab of the upper part of the front cover into the groove of the inverter. Press the lower part of front cover onto the plastic case until the cover snaps shut. Tighten the screws.

- **Removing option cover**

- After removing front cover, remove the option cover to direction 2 with section A as a supporting point.

- **Mounting option cover**

- Mount the terminal cover in the reverse order of the above removal procedure.

- **Removing upper/bottom covers**

- After removing front cover, lift the top and bottom covers to direction 1.

- **Mounting upper/bottom covers**

- Mount the front cover in the reverse order of the above removal procedure.

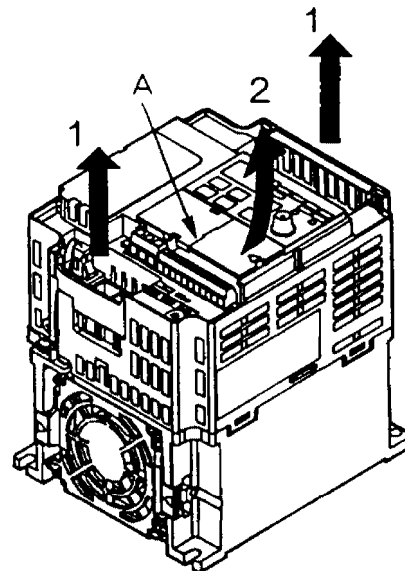

Notes

5. WIRING

• Wiring Instructions

- (1) Always connect the power supply via a molded-case circuit breaker (MCCB) to the power input terminals R/L1, S/L2, and T/L3 (R/L1, S/L2 for single-phase). Never connect the power supply to U/T1, V/T2, W/T3,-,+1 or +2.

The single-phase (200V class) inverter can be connected to a 200V 3-phase input. However, when a single-phase supply is used, never use the terminal T/L3 for other purposes.

Inverter Power Supply Connection Terminals

200V 3-phase Input Power Supply Specification Product CIMR-J7□□2□□□	200V Single Input Power Supply Specification Product. CIMR-J7□□B□□□	400V 3-phase Input Power Supply Specification Product. CIMR-J7□□4□□□
Connect to R/L1, S/L2, T/L3	Connect to R/L1, S/L2	Connect to R/L1, S/L2, T/L3

- (2) Connect the motor wiring to terminals U, V, and W on the main circuit output side (bottom of the inverter).
- (3) If the wiring distance between inverter and motor is long, reduce the inverter carrier frequency. For details, refer to “Reducing motor noise or leakage current (n46)” on page 79.
- (4) Control wiring must be less than 164ft(50m) in length and separate from the power wiring. Use twisted-pair shielded wire when inputting the frequency signal externally.
- (5) Tighten the screws on the main circuit and control circuit terminals.
- (6) Do not connect or disconnect wiring, or perform signal checks while the power supply is turned ON.

• Wire and Terminal Screw Sizes

1. Control Circuit

Model	Terminal Symbol	Screw	Tightening Torque lb • in (N • m)	Wire				Type
				Applicable size		Recommend size		
				mm ²	AWG	mm ²	AWG	
Common to all models	MA, MB, MC	M3	4.44 to 5.33 (0.5 to 0.6)	twisted wire 0.5 to 1.25 single 0.5 to 1.25	20 to 16 20 to 16	0.75	18	Shielded wire or equivalent
	S1 to S5,SC,FS,FR,FC,AM,AC	M2	1.94 to 2.21 (0.22 to 0.25)	twisted wire 0.5 to 0.75 single 0.5 to 1.25	20 to 18 20 to 16	0.75	18	

2. Main Circuit

200V Class 3-phase Input Series

Model	Terminal Symbol	Screw	Tightening Torque lb • in (N • m)	Wire				Type
				Applicable size		Recommended size		
				mm ²	AWG	mm ²	AWG	
CIMR-J7*U20P1	R/L1,S/L2,T/L3,-,+1,+2,U/T1,V/T2,W/T3 Ⓢ	M3.5	7.1 to 8.88 (0.8 to 1.0)	0.75 to 2	18 to 14	2	14	600V vinyl-sheathed wire or equivalent
CIMR-J7*U20P2	R/L1,S/L2,T/L3,-,+1,+2,U/T1,V/T2,W/T3 Ⓢ	M3.5	7.1 to 8.88 (0.8 to 1.0)	0.75 to 2	18 to 14	2	14	
CIMR-J7*U20P4	R/L1,S/L2,T/L3,-,+1,+2,U/T1,V/T2,W/T3 Ⓢ	M3.5	7.1 to 8.88 (0.8 to 1.0)	0.75 to 2	18 to 14	2	14	
CIMR-J7*U20P7	R/L1,S/L2,T/L3,-,+1,+2,U/T1,V/T2,W/T3 Ⓢ	M3.5	7.1 to 8.88 (0.8 to 1.0)	0.75 to 2	18 to 14	2	14	
CIMR-J7*U21P5	R/L1,S/L2,-,+1,+2,U/T1,V/T2,W/T3 Ⓢ	M3.5	7.1 to 8.88 (0.8 to 1.0)	2 to 5.5	14 to 10	2	14	
CIMR-J7*U22P2	R/L1,S/L2,-,+1,+2,U/T1,V/T2,W/T3 Ⓢ	M3.5	7.1 to 8.88 (0.8 to 1.0)	2 to 5.5	14 to 10	3.5	14	
CIMR-J7*U23P7	R/L1,S/L2,-,+1,+2,U/T1,V/T2,W/T3 Ⓢ	M4	10.7 to 13.3 (1.2 to 1.5)	2 to 5.5	14 to 10	5.5	10	

Note: The wire size indicated is for copper wires at 160°F (75°C)

200V Class Single-phase Input Series

Model	Terminal Symbol	Screw	Tightening Torque lb • in (N • m)	Wire				Type
				Applicable size		Recommended size		
				mm ²	AWG	mm ²	AWG	
CIMR-J7*UB0P1	R/L1,S/L2,T/L3,-,+1,+2,U/T1,V/T2,W/T3 Ⓢ	M3.5	7.1 to 8.88 (0.8 to 1.0)	0.75 to 2	18 to 14	2	14	600V vinyl-sheathed wire or equivalent
CIMR-J7*UB0P2	R/L1,S/L2,T/L3,-,+1,+2,U/T1,V/T2,W/T3 Ⓢ	M3.5	7.1 to 8.88 (0.8 to 1.0)	0.75 to 2	18 to 14	2	14	
CIMR-J7*UB0P4	R/L1,S/L2,T/L3,-,+1,+2,U/T1,V/T2,W/T3 Ⓢ	M3.5	7.1 to 8.88 (0.8 to 1.0)	0.75 to 2	18 to 14	2	14	
CIMR-J7*UB0P7	R/L1,S/L2,T/L3,-,+1,+2,U/T1,V/T2,W/T3 Ⓢ	M4	7.1 to 8.88 (0.8 to 1.0)	2 to 5.5	14 to 10	3.5 2	12 14	
CIMR-J7*UB1P5	R/L1,S/L2,T/L3,-,+1,+2,U/T1,V/T2,W/T3 Ⓢ	M4	7.1 to 8.88 (0.8 to 1.0)	2 to 5.5	14 to 10	5.5 2	10 14	

Note: The wire size indicated is for copper wires at 160°F (75°C)

Note: Three-phase input is also acceptable for single-phase input series.

400V Class 3-phase Input Series

Model	Terminal Symbol	Screw	Tightening Torque lb • in (N • m)	Wire				Type				
				Applicable size		Recommended size						
				mm ²	AWG	mm ²	AWG					
CIMR-J7*U40P2	R/L1,S/L2,T/L3,-,+1,+2,U/T1,V/T2,W/T3	M3.5	7.1 to 8.88 (0.8 to 1.0)	2 to 5.5	14 to 10	2	14	600V vinyl-sheathed wire or equivalent				
	Ⓟ											
CIMR-J7*U40P4	R/L1,S/L2,T/L3,-,+1,+2,U/T1,V/T2,W/T3	M3.5	7.1 to 8.88 (0.8 to 1.0)	2 to 5.5	14 to 10	2	14		600V vinyl-sheathed wire or equivalent			
	Ⓟ											
CIMR-J7*U40P7	R/L1,S/L2,T/L3,-,+1,+2,U/T1,V/T2,W/T3	M3.5	7.1 to 8.88 (0.8 to 1.0)	2 to 5.5	14 to 10	2	14			600V vinyl-sheathed wire or equivalent		
	Ⓟ											
CIMR-J7*U41P5	R/L1,S/L2,T/L3,-,+1,+2,U/T1,V/T2,W/T3	M3.5	7.1 to 8.88 (0.8 to 1.0)	2 to 5.5	14 to 10	2	14				600V vinyl-sheathed wire or equivalent	
	Ⓟ											
CIMR-J7*U42P2	R/L1,S/L2,T/L3,-,+1,+2,U/T1,V/T2,W/T3	M4	10.65 to 13.31 (1.2 to 1.5)	2 to 5.5	14 to 10	2	14					600V vinyl-sheathed wire or equivalent
	Ⓟ											
CIMR-J7*U43P0	R/L1,S/L2,T/L3,-,+1,+2,U/T1,V/T2,W/T3	M4	10.65 to 13.31 (1.2 to 1.5)	2 to 5.5	14 to 10	2	14	600V vinyl-sheathed wire or equivalent				
	Ⓟ					3.5	12					
CIMR-J7*U43P7	R/L1,S/L2,T/L3,-,+1,+2,U/T1,V/T2,W/T3	M4	10.65 to 13.31 (1.2 to 1.5)	2 to 5.5	14 to 10	2	14		600V vinyl-sheathed wire or equivalent			
	Ⓟ					3.5	12					

Note: The wire size indicated is for copper wires at 160°F (75°C)

• Wiring the Main Circuit

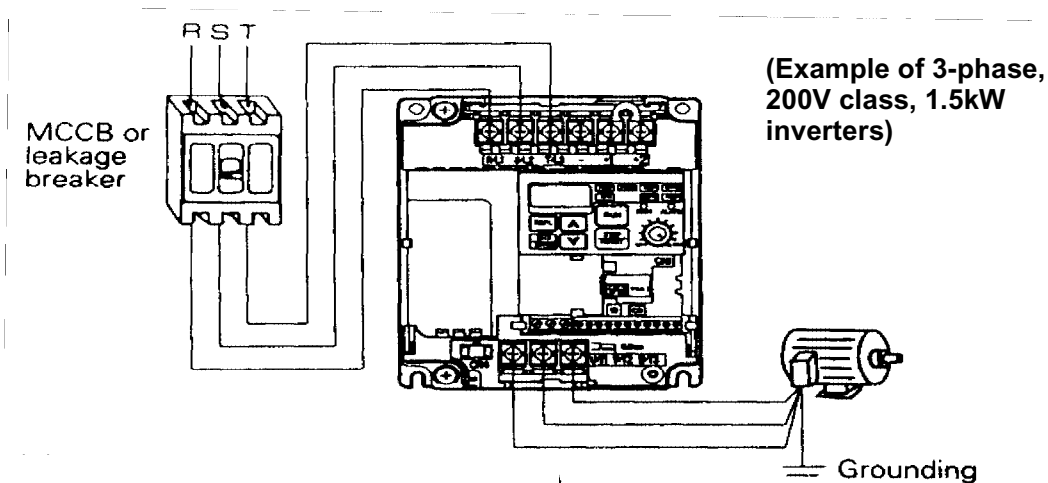

• Main Circuit Input Power Supply

Connect the power supply wiring to input terminals L1 (R), L2(S) and L3(T) [L1(R), L2(S) for single-phase inverters]. Never connect them to U/T1, V/T2, W/T3, -, +1, or +2. Otherwise the inverter may be damaged. Single-phase voltage may be connected to inverter but do not use terminal T/L3 for any other purposes.

 On Single-phase models, terminal T/L3 is connected internally within the inverter. Never use the terminal for other purposes.

• Grounding (Use ground terminal)

Make sure to ground the ground terminal  according to the local grounding code. Never ground the VS mini J7 to welding machines, motors, or other electrical equipment.

When several VS mini J7 units are used side by side, ground each unit as shown in examples. Do not loop the ground wires.

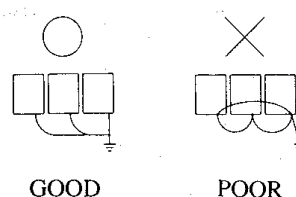

• Wiring the Main Circuit Terminals

Pass the cables through wiring hole and connect. Be sure to mount the cover in its original position.

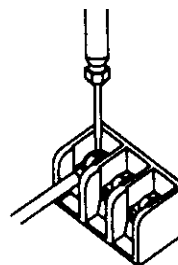

Connect with a Phillips (plus) screwdriver.

• Recommended Peripheral Devices

It is recommended that the following peripheral devices be mounted between the AC main circuit power supply and VS mini J7 input terminals R/L1, S/L2, and T/L3.

- MCCB (Molded-case circuit breaker):

A circuit breaker should be connected for wiring protection.

- Magnetic contactor:

Mount a surge suppressor on the coil (refer to the table shown below).

To assure optimum inverter life when using a magnetic contactor to start and stop the inverter, do not exceed one stop per hour.

Recommended MCCB and magnetic contactor

- 200V 3-Phase

VS mini J7 model	J7 ** 20P1	J7 ** 20P2	J7 ** 20P4	J7 ** 20P7	J7 ** 21P5	J7 ** 22P2	J7 ** 23P7
Capacity (kVA)	0.3	0.6	1.1	1.9	3.0	4.2	6.7
Rated Output Current (A)	0.8	1.6	3	5	8	11	17.5
MCCB type NF30 (MITSUBISHI)	5A	5A	5A	10A	20A	20A	30A
Magnetic contactor type HI (YASKAWA CONTROL)	HI-7E	HI-7E	HI-7E	HI-7E	HI-10-2E	HI-10-2E	HI-20E

- 200V single-Phase

VS mini J7 model	J7 ** B0P1	J7 ** B0P2	J7 ** B0P4	J7 ** B0P7	J7 ** B1P5
Capacity (kVA)	0.3	0.6	1.1	1.9	3.0
Rated Output Current (A)	0.8	1.6	3	5	8
MCCB type NF30, NF50 (MITSUBISHI)	5A	5A	10A	20A	20A
Magnetic contactor type HI (YASKAWA CONTROL)	HI-7E	HI-7E	HI-7E	HI-10-2E	HI-15E

- 400V 3-Phase

VS mini J7 model	J7 ** 40P1	J7 ** 40P2	J7** 40P4	J7 ** 41P5	J7 ** 42P2	J7 ** 43P7
Capacity (kVA)	0.9	1.4	2.6	3.7	4.2	7.0
Rated Output Current (A)	1.2	1.8	3.4	4.8	5.5	9.2
MCCB type NF30, NF50 (MITSUBISHI)	5A	5A	5A	10A	10A	20A
Magnetic contactor type HI (YASKAWA CONTROL)	HI-7E	HI-7E	HI-7E	HI-10-2E	HI-10-2E	HI-10-2E

Surge suppressors

Surge Suppressors		Model DCR2-	Specifications	Code No.
Coils and relays				
200V to 230V	Large size magnetic contactors	50A22E	250VAC 0.5 μ F 200 Ω	C002417
	Control relays MY-2, -3 (OMRON) HH-22, -23 (FUJI) MM-2, -4 (OMRON)	10A25C	250VAC 0.1 μ F 100 Ω	C002482

- Ground fault interrupter:

Select a ground fault interrupter not affected by high frequencies. To prevent malfunctions, the leakage current sensitivity should be 200mA or more and the operating time 0.1 sec. or more.

Example: • NV series by Mitsubishi Electric Co., Ltd. (manufactured in 1988 and after).

 - EGSG series by Fuji Electric Co., Ltd.(manufactured in 1984 and after).
- AC and DC reactor:

Install an AC reactor to connect to a power supply transformer of large capacity (600kVA or more) or to improve power factor on the power supply side.
- Noise filter:

Use a noise filter exclusively for inverter if radio noise generated from the inverter causes other control devices to malfunction.

NOTE: (1) Never connect a general LC/RC noise filter to the inverter output circuit.

(2) Do not connect a phase advancing capacitor to the I/O sides and/or a surge suppressor to the output side.

(3) When a magnetic contactor is installed between the inverter and the motor, do not turn it ON/Off during operation.

For the details of the peripheral devices, refer to the catalog.

• Wiring the Control Circuit

Only basic insulation is provided for the control circuit terminals.
Additional insulation may be necessary in the end product.

- Control Circuit terminals

Pass the cable through wiring hole and connect. Be sure to mount all the covers in the original position.

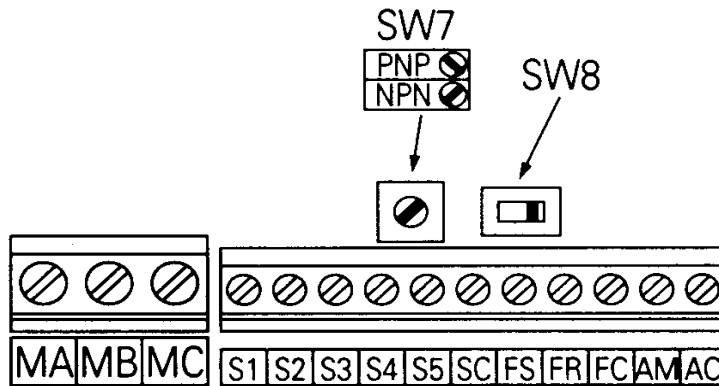

- * SW7 can be changed according to sequence input signal (S1 to S5) polarity.
0V common: NPN side (factory setting)
24 common: PNP side
Refer to pages 89 for SW8

Wiring the control circuit terminals

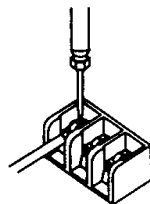

Screwdriver blade width

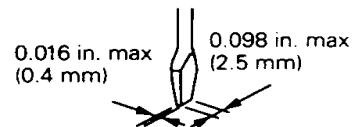

Insert the wire into the lower part of the terminal block and connect it tightly with a screwdriver.

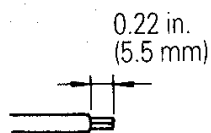

Wire sheath strip length must be 0.22 in. (5.5mm).

Open the front cover and verify that the strip length is 0.22 in. (5.5mm)

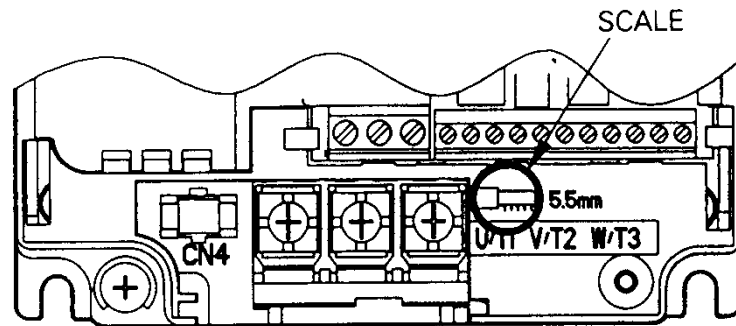

• Wiring Inspection

After completing wiring, check the following:

- Wiring is properly connected.
- Wire clippings or screws are not left inside the unit.
- Screws are securely tightened.
- Bare wires in the terminal do not come in contact with other terminals.

 If the FWD (REV) run command is given during the operation reference selection (n02=1) from the control circuit terminal, the motor will start automatically after the main circuit input power supply is turned ON.

6. OPERATING THE INVERTER

• Test Run

The inverter operates by setting the frequency (speed).

There are three types of operation modes for the VS mini J7:















1. Run command from the digital operator (local potentiometer/digital setting).
2. Run command from the control circuit terminal.
3. Run command from communications (MEMOBUS).

(Communication option card is required)

Prior to shipping, the drive is set up to receive run command and frequency reference from the control circuit terminal. Following are instructions for running the VS mini J7 using the digital operator (with volume). For instructions on operation, refer to page 47.

Operation reference or frequency reference parameters can be selected separately as shown below.

Name	Parameter
Operation Reference Selection	n02 = 0 --- Enables operator RUN, STOP/RESET = 1 --- Enables control circuit terminal run/stop = 2 --- Enables communications (MEMOBUS)
Frequency Reference Selection	n03 = 0 --- Enables operator volume = 1 --- Enables frequency reference 1 (parameter 24) = 2 --- Enables voltage reference (0 to 10V) of control circuit terminal = 3 --- Enables current reference (4 to 20mA) of control circuit terminal = 4 --- Enables current reference (0 to 20mA) of control circuit terminal = 6 --- Enables communications (MEMOBUS)

Operation Steps	Operator Display	12-LED Display	Status Indicator LED
1. Turn the local pot (volume control) fully counter clockwise after turning the power ON.	0.00	FREF	RUN  ALARM 
2. Press DSPL 5 times to illuminate Lo/RE Select Lo (local mode) using  or  key	Lo	Lo/RE	RUN  ALARM 
3. F/R blinks. Select FWD/REV run using keys  Never select REV when reverse run is prohibited.	For or REV	F/R	RUN  ALARM 
4. Press DSPL to illuminate FREF. Then press RUN.	0.00	FREF	RUN  ALARM 
5. Operate the motor by turning the volume clockwise. (Frequency reference corresponding to the volume position is displayed.)  If the volume is switched rapidly, the motor also accelerates or decelerates rapidly corresponding to the volume movement. Pay attention to load status and adjust the volume to the desired speed.	0.00 to 60.00 Minimum output frequency is 1.5Hz	FREF	RUN  ALARM 

Status indicator lamp  : ON  : Blinking  : OFF

Operation Check Points

- Motor rotates smoothly.
- Motor rotates in the correct direction.
- Motor does not have abnormal vibration or noise.
- Acceleration or deceleration is smooth.
- Current is appropriate for the load (No overload).
- Status indicator LED's and digital operator display are correct.

• Operating the Digital Operator

All functions of the VS mini J7 are set by the digital operator. Below are descriptions of the display and keypad sections.

Digital Operator

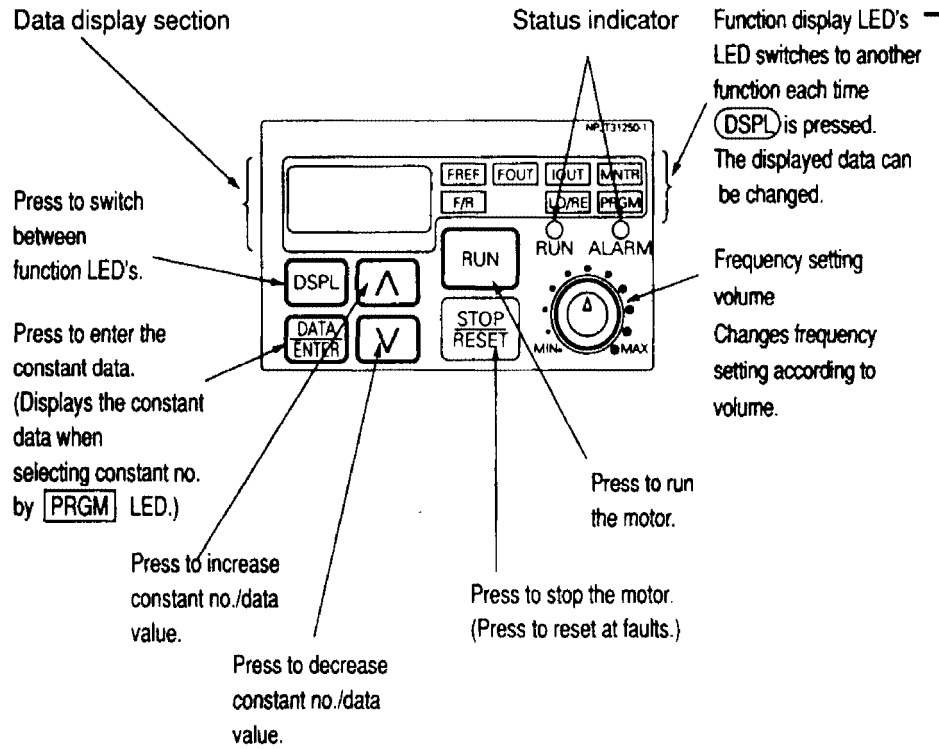

Color in parenthesis indicates the color of LED.

FREF Frequency reference setting/monitoring (GREEN)	FOUT Output frequency monitor (GREEN)	IOUT Output current monitor (GREEN)	MNTR Multi-function monitor (GREEN)
F/R Operator RUN command FWD/REV selection (GREEN)		LO/RE LOCAL/REMOTE Selection (RED)	PRGM Constant no./data (RED)

Description of Status Indicator LED's

There are two LED's on the middle right section of the face of the VS mini. The inverter status is indicated by various combinations of the LED's (ON, BLINKING and OFF). RUN indicator and status indicator of the **RUN** button have the same functions.

☀ : ON ⚡ : BLINKING (Long Blinking) ⚡ : BLINKING ● : OFF

RUN ALARM	Operation Ready (During Stop)	Ramp to Stop	Normal Operation
○ ○ (Green) (Red)	⚡ ●	⚡ ●	☀ ●

For details on how the status indicator LED's function at inverter faults, refer to Section 8 "FAULT DIAGNOSIS AND CORRECTIVE ACTIONS" on page 103. If a fault occurs, the ALARM LED lights.

 The fault can be reset by turning ON the fault reset signal (or pressing **STOP/RESET** key on the digital operator) when the operation signal is removed or by turning OFF the power supply. If the operation signal is ON, the fault cannot be reset by the fault reset signal.

• LED Description

By pressing (DSPL) on the digital operator, each of the function LED's can be selected.

The following flowchart describes each function LED.

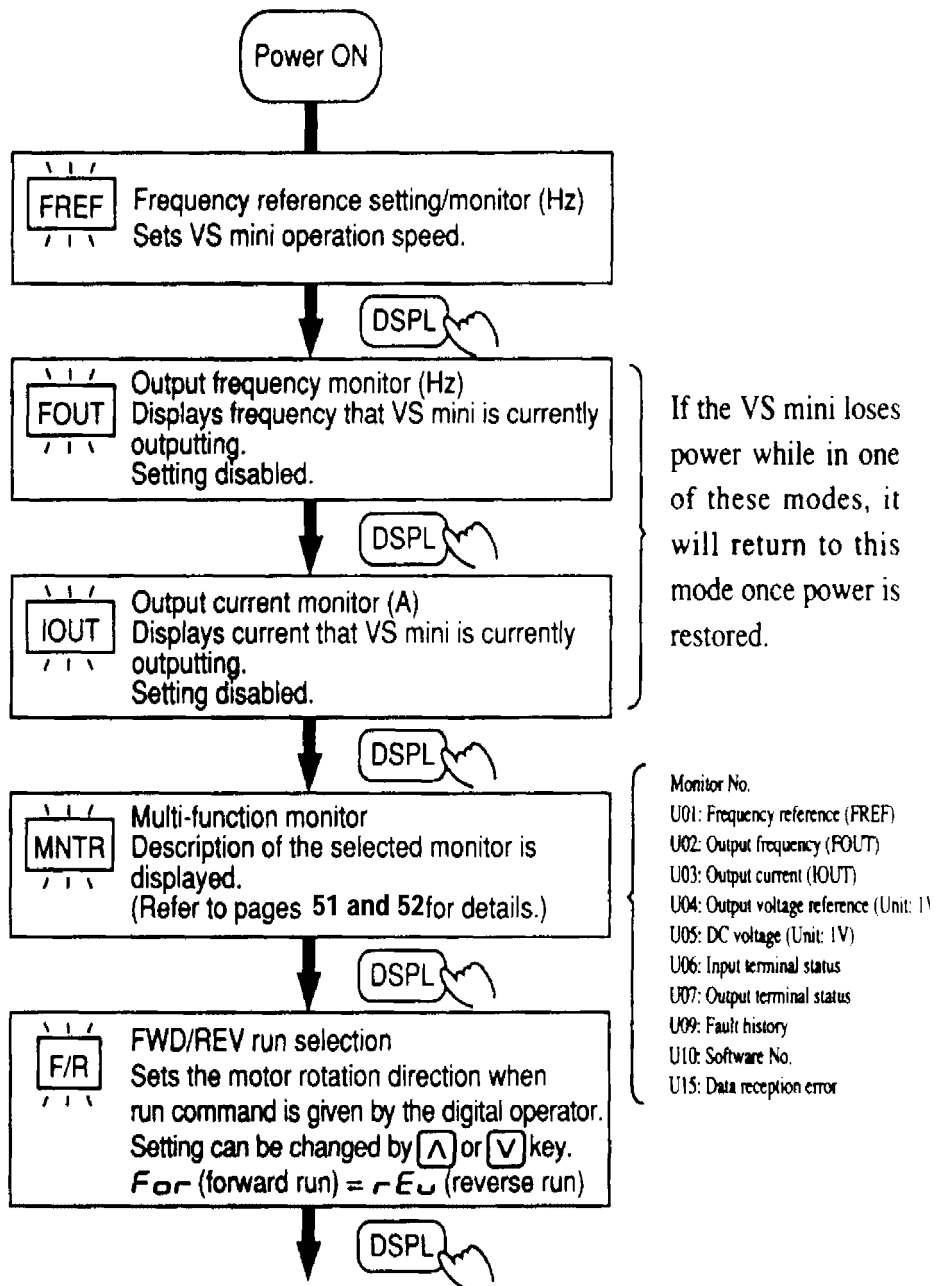

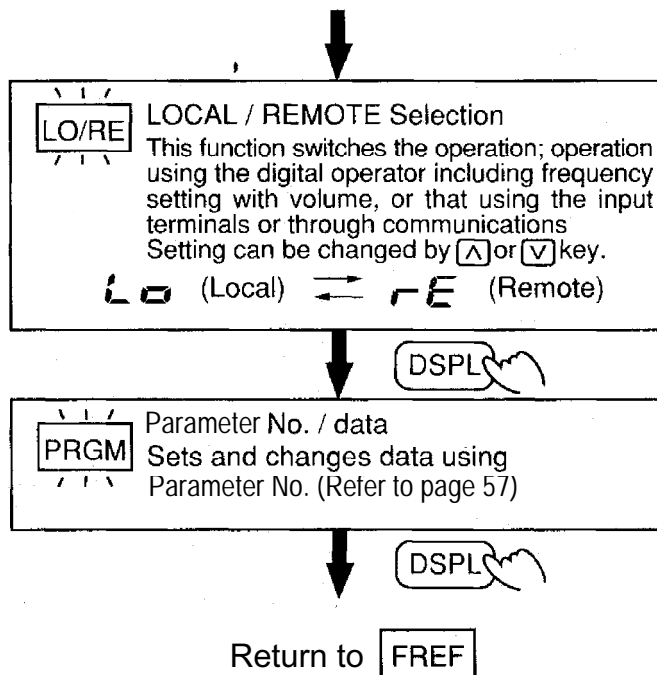

MNTR Multi-Function monitor

• **Selecting monitor**

Press **DSPL** key. When **MNTR** is ON, data can be displayed by selecting monitor No.

[Example] Monitoring Output Voltage Reference

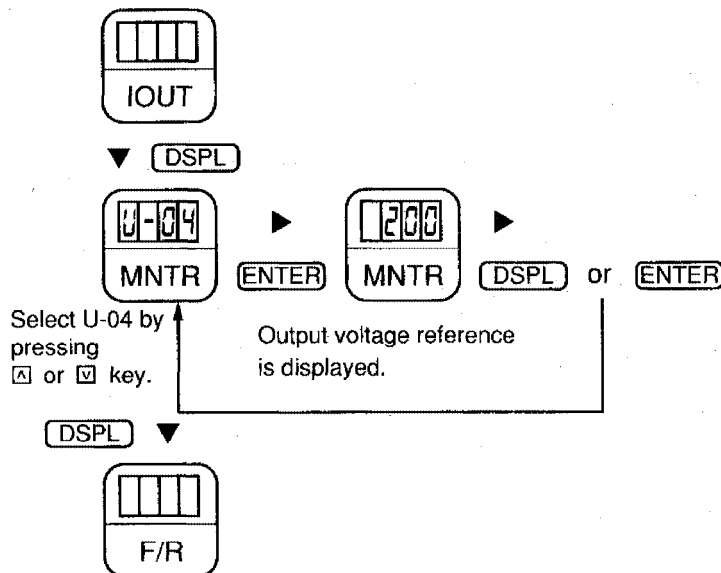

• **Monitoring**

Following items can be monitored by U-parameters

Parameter No.	Name		Description
U-01	Frequency reference (FREF)	Hz	Frequency reference can be monitored. (Same as FREF)
U-02	Output frequency (FOUT)	Hz	Output frequency can be monitored. (Same as FOUT)
U-03	Output current (IOUT)	AMP	Output current can be monitored. (Same as IOUT)
U-04	Output voltage	V	Output voltage can be monitored.
U-05	DC voltage	V	Main circuit DC bus voltage can be monitored.
U-06	Input terminal status	—	Input terminal status of control circuit terminals can be monitored.
U-07	Output terminal status	—	Output terminal status of control circuit terminals can be monitored.
U-09	Fault history	—	Last four fault history is displayed.
U-10	Software No.	—	Software No. can be checked.
U-15	Data reception error	—	Contents of MEMOBUS communications data reception error can be checked. (contents of transmission register No. 003DH are the same)

Input terminal status

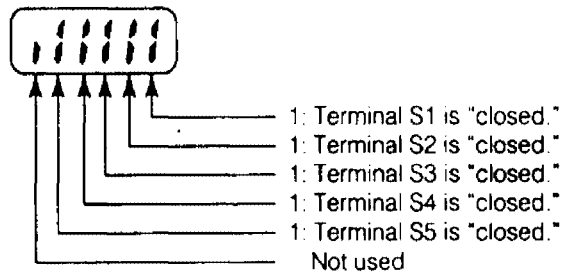

Output terminal status

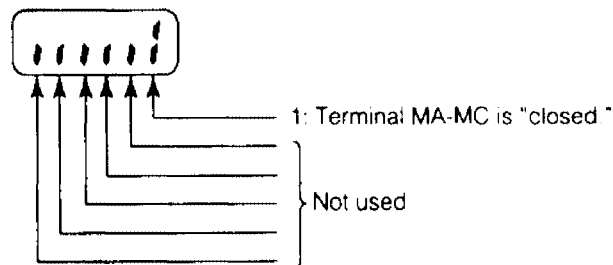

Fault history display method

Fault description is displayed when U09 is selected.

(Example)

□□□: Fault description (“---” is displayed if there is no fault.)
 (Refer to page 103 for details.)

- Clearing fault history
 Set parameter n001 to 6 to clear fault history. Set data returns to its initial value after completion of 6 setting.

Note: Parameter initialize (n01 = 10, 11) also clears the fault history.

Setting and referring parameters

The following figure shows how to select and change parameters.

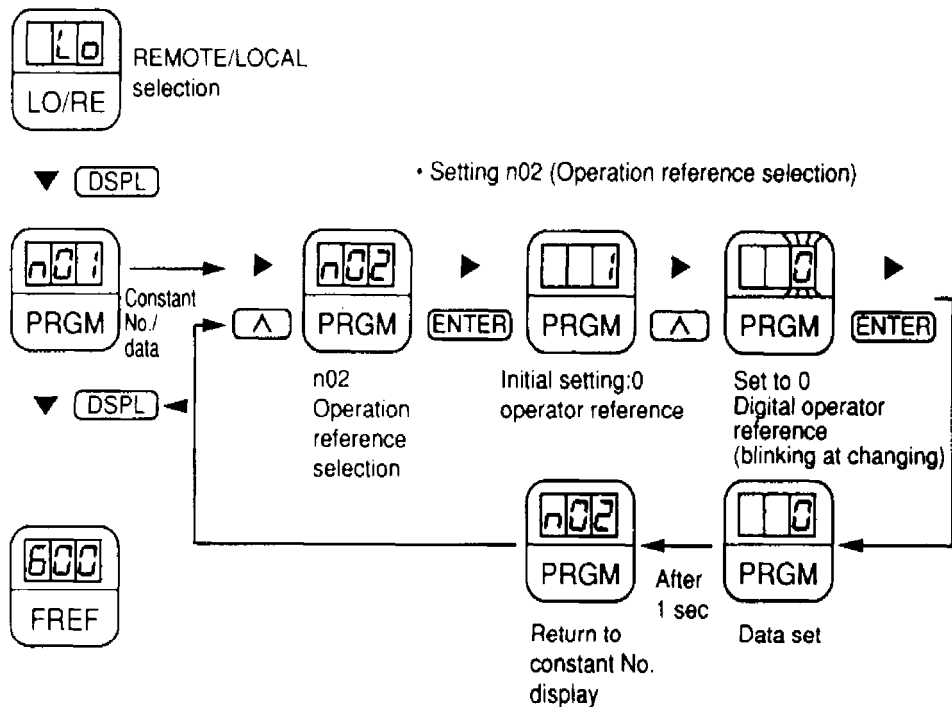

• Simple Data Setting

Volume setting (Refer to 5, OPERATING THE INVERTER) and digital setting are both available for simple accel/decel operation of the VS mini.

Frequency reference by analog voltage is set with initial setting (n03 = 2).

Following is an example in which the function LEDs are used to set frequency reference, acceleration time, deceleration time, and motor direction.

Operation Steps	Operator Display	LED Display	Status Indicator LED
1. Turn ON the power supply.	0.0		RUN ALARM
2. Set constant n07 to 1.	1		RUN ALARM
3. Set the following constants. n16 : 15.0 (acceleration time) n17 : 5.0 (deceleration time)	15.0 5.0		RUN ALARM
4. Select forward or reverse run by pressing or key. NOTE Examine the application. (Never select REW when reverse run is prohibited.)	<i>For</i> (Forward) or <i>rEv</i> (Reverse)		RUN ALARM
5. Select Lo (local mode) by pressing or key.	Lo		RUN ALARM
6. Set the reference by pressing or key.	60.0		RUN ALARM
7. Press .	0.0 → 60.0		RUN ALARM
8. Press to stop.	60.0 → 0.0		RUN ALARM

Status indicator lamp : Blinking (Long Blinking) : Blinking : OFF

Notes

7. PROGRAMMING FEATURES

Factory settings of the parameters are shown as in the tables.

• Parameter Set-up and Initialization

Parameter selection/initialization (n01)

The following table describes the data which can be set or read when n01 is set.

Unused parameters among n01 to n79 are not displayed.

n001 Setting	Parameter that can be set	Parameter that can be viewed
0	n01	n01 to n79
1	n01 to n79*	n01 to n79
6	Fault history cleared	
7	Not used	
10	Initialize (2-wire sequence)	
11	Initialize (3-wire sequence)=	

* Excluding setting disabled parameters.

= Refer to page 85.



“Err” appears on the LED display for one second and the set data returns to its initial values in the following cases:

- (1) The set values of input terminal function selection 2 to 5 (n36 to n39) are the same.
- (2) The following conditions are not satisfied in the V/f pattern setting:
 - Max. output frequency (n09) \geq Max. voltage output frequency (n11)
 - > Mid. output frequency (n12)
 - \geq Min. output frequency (n14)
 For details, refer to “Adjusting torque according to application” (V/f pattern setting) on page 56.
- (3) If the following conditions are not satisfied in the Jump frequency setting:
 - Jump frequency 2 (n50) \leq Jump frequency 1 (n49)
- (4) If Frequency reference lower limit (n31) \geq Frequency reference upper limit (n30)
- (5) If motor rated current (n32) \geq 150% of inverter rated current

• Selecting V/f pattern

Adjusting torque according to application

Adjust motor torque by using “V/f pattern” and “full-range automatic torque boost”.

• V/f pattern setting

Set V/f pattern by parameters n09 to n15 as described below. Set each pattern when using a special motor (high-speed motor, etc.) or when requiring special torque adjustment of machine.

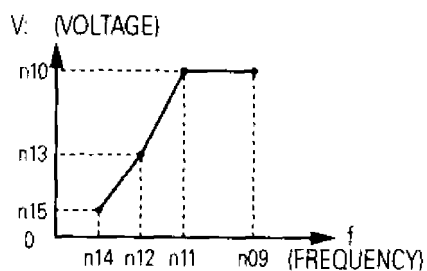

Be sure to satisfy the following conditions for the setting of n09 to n15.

$$n14 \leq n12 < n11 \leq n09$$

If $n14 = n12$, the set value of n13 is disabled.

Parameters No.	Name	Unit	Setting range	Initial Setting
n09	Max. output frequency	0.1Hz	50.0 to 400Hz	60.0Hz
n10	Max. voltage	1V	1 to 255V (0.1 to 510V)	230V (460V)
n11	Max. voltage output frequency (base frequency)	0.1Hz	0.2 to 400Hz	60.0Hz
n12	Mid. output frequency	0.1Hz	0.1 to 399Hz	1.5Hz
n13	Mid. output frequency voltage	1V	0.1 to 255V (0.1 to 510V)	12V (24V)
n14	Min. output frequency	0.1Hz	0.1 to 10.0Hz	1.5Hz
n15	Min. output frequency voltage	1V	1 to 50V (0.1 to 100V)	12V (24V)

- **Typical setting of V/f pattern**

Set the V/f pattern according to the application as described below. For 400V class, the voltage values (n10, n13, and n15) should be doubled. When running at a frequency exceeding 50Hz/60Hz, change the maximum output frequency (n09).

Note: Be sure to set the maximum output frequency according to the motor characteristics.

(1) For general-purpose applications

Motor Specification : 60Hz
(Factory setting)

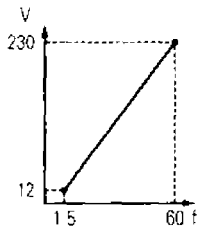

Constant	Setting
n09	60.0
n10	230
n11	60.0
n12	1.5
n13	12
n14	1.5
n15	12

Motor Specification : 50Hz

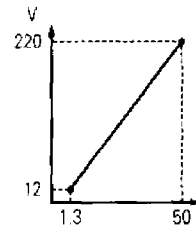

Constant	Setting
n09	50.0
n10	220
n11	50.0
n12	1.3
n13	12
n14	1.3
n15	12

(2) For fans/pumps

Motor Specification : 60Hz

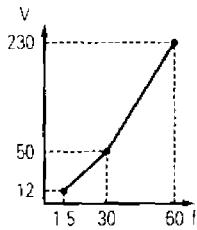

Constant	Setting
n09	60.0
n10	230
n11	60.0
n12	30.0
n13	50
n14	1.5
n15	10

Motor Specification : 50Hz

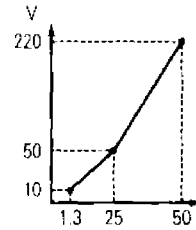

Constant	Setting
n09	50.0
n10	220
n11	50.0
n12	25.0
n13	50
n14	1.3
n15	10

(3) For applications requiring high starting torque

Motor Specification : 60Hz

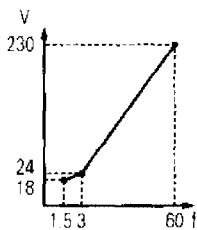

Constant	Setting
n09	60.0
n10	230
n11	60.0
n12	3.0
n13	24
n14	1.5
n15	18

Motor Specification : 50Hz

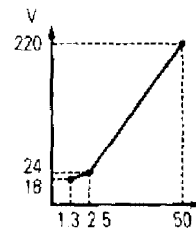

Constant	Setting
n09	50.0
n10	220
n11	50.0
n12	2.5
n13	24
n14	1.3
n15	18

Increasing voltage of V/f pattern increases motor torque, but excessive increase may cause motor over excitation, motor overheat, or vibration.

When operating with frequency larger than 60Hz/50Hz, change only maximum output frequency (n09).

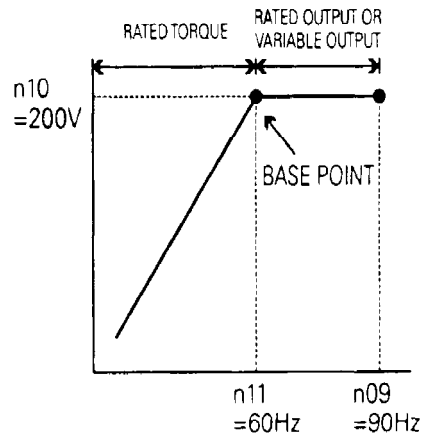

- **Full-range automatic torque boost**

Motor torque requirement changes according to load conditions. Full range automatic torque boost adjusts voltage of V/f pattern according to the requirement. The VS mini J7 automatically adjusts the voltage during constant-speed operation as well as during acceleration.

The required torque is calculated by the inverter. This ensures tripless operation and energy-saving effects.

$$\boxed{\text{Output voltage}} \propto \boxed{\text{Torque compensation gain (n63)}} \times \boxed{\text{Required torque}}$$

Operation

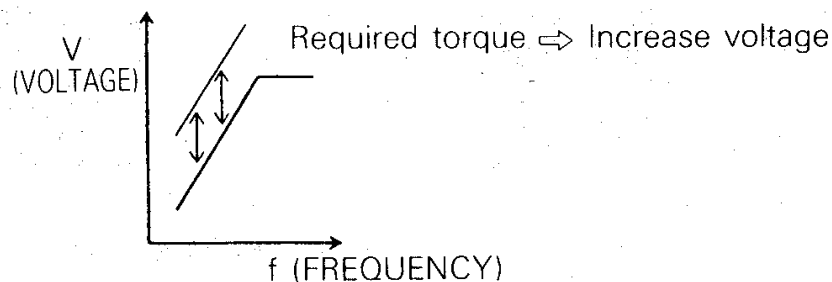

Normally, no adjustment is necessary for torque compensation gain (n63 factory setting: 1.0). When wiring distance between the inverter and motor is long or when motor generates vibration, change the automatic torque compensation gain. In these cases, it may also be beneficial to adjust the V/f pattern (n09 to n15).

- **Switching LOCAL/REMOTE Modes**

The following functions can be selected by switching the LOCAL or REMOTE mode. To select RUN/STOP commands or frequency reference, change the mode in advance depending on the following applications.

- **LOCAL Mode:**

Enables the digital operator for RUN/STOP commands and FWD/REV run commands. Frequency reference can be set by volume or .

- **REMOTE Mode:**

Run by the n02 setting (operation reference selection).

Frequency reference can be set by n03 (frequency reference selection) setting.

- **How to select LOCAL/REMOTE modes**

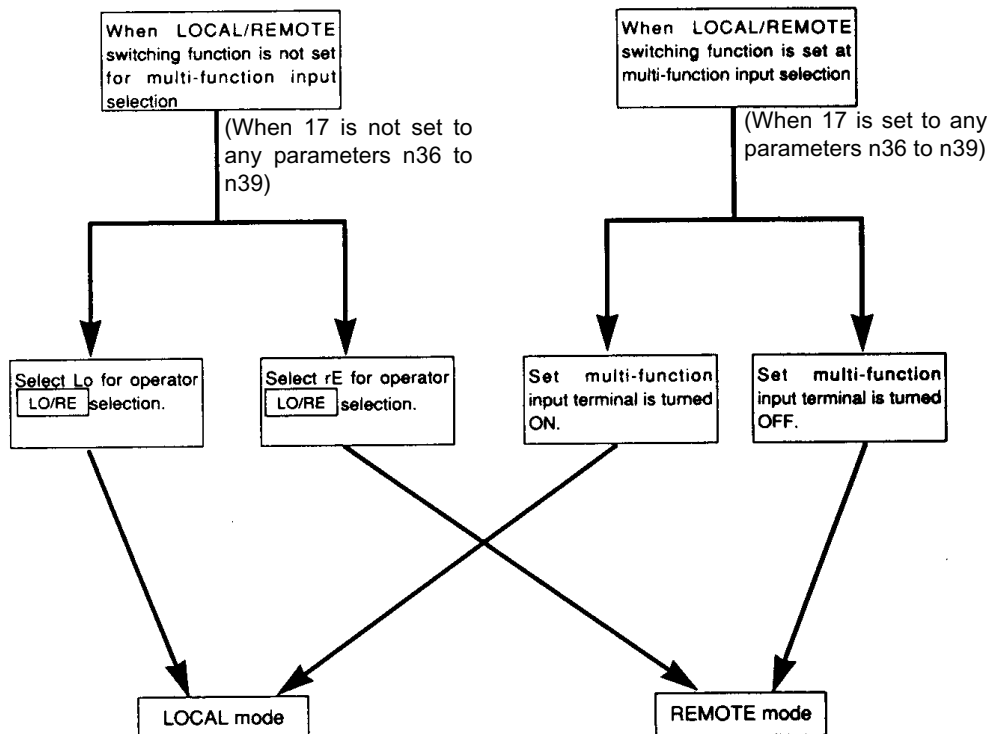

- **Selecting Run/Stop Commands**

Refer to page 63 to select either the LOCAL mode or REMOTE mode. Operation method (RUN / STOP commands, FWD / REV run commands) can be selected by the following method.

- **LOCAL Mode**

When Lo (local mode) is displayed on the digital operator (when **LO/RE** is illuminated), or when the LOCAL / REMOTE changeover function is set as a multi-function input and the input terminal is turned ON, run operation is enabled by the **STP** or **RUN** of the digital operator. FWD/REV is selected by illuminating **F/R** and using **^** or **v** key to select FWD or REV.

- **REMOTE mode**

- Select remote mode

The following two methods are used to select remote mode:

1. Select rE (remote mode) for **LO/RE** selection.
2. When the local / remote switching function is selected as multi-function input selection, turn OFF the input terminal to select remote mode.

- Select operation method by setting the parameter n02.

n02=0: Enables the digital operator (same with local mode)
=1: Enables the multi-function input terminal (see fig. below)
=2: Enables communications (refer to page 96)

- Example for using the multi-function input terminal as operation reference (two-wire sequence) follows. For 3-wire sequencing, refer to page 85.

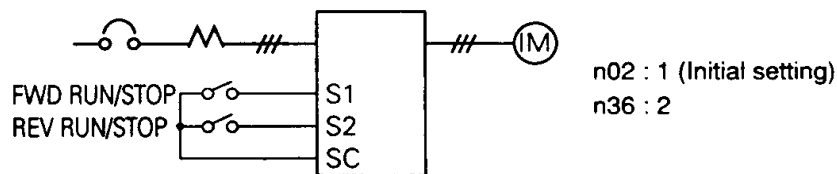

- **Operating (RUN /STOP commands) by communications (When option card is installed)**

Setting parameter n02 to 2 in REMOTE mode can give RUN / STOP commands by communication (MEMOBUS). For details, refer to page 96.

- **Selecting Frequency Reference**

Frequency reference can be selected by the following methods.

- **Setting by operator**

Select REMOTE or LOCAL mode in advance. For the method of selecting the mode, refer to page 62.

LOCAL mode

Parameter n07 determines where the frequency reference is input from when in the local mode.

n07 =0: Enables the setting by volume on digital operator (initial setting)

Factory setting of the model with operator (without volume) is n07=1.

=1: Enables the digital setting by digital operator, setting value is stored in parameter n21 (frequency reference 1).

- **Digital setting by digital operator**

Input frequency while FREF is illuminated (press ENTER after setting the desired frequency value).

Frequency reference setting is immediately effective when n08 = 1 The ENTER key does not have to be pressed to enter the reference.

n08 =0: Enables frequency reference acceptance by ENTER key.

=1: Disable frequency reference setting by ENTER key. It is not necessary to press the ENTER key to accept the reference.

REMOTE mode

Parameter n03 determines where the frequency reference is accepted from when in the REMOTE mode.

n03 =0: Enables frequency reference setting by volume on digital operator.

=1: Frequency reference 1 (parameter n21) is effective

=2: Voltage reference terminal “FR” is effective (0 to 10V)

(See the figure below)

=3: Current reference terminal “FR” is effective(4 to 20mA)

(Refer to page 90)*

=4: Current reference terminal “FR” is effective (0 to 20mA)

(Refer to page 90)*

=6: Communication (Refer to page 97)

*NOTE: SWB must be set to the “I” position when using terminal “FR” as a current reference input.

Example of frequency reference by voltage signal

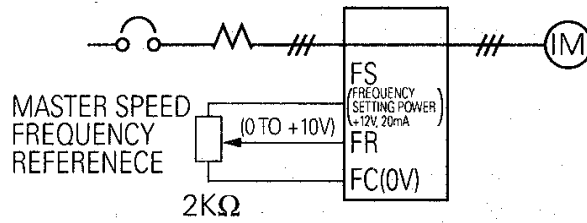

n03: 2 (factory setting)

SW8 is set to “V” position when using terminal “FR” as a voltage reference (default setting)

• Setting Operation Conditions

Reverse run prohibit (n06)

The “Reverse run disabled” setting will not accept a reverse run command from the control circuit terminal or digital operator. This setting is used for applications where a reverse run command is undesirable.

Setting	Description
0	Reverse run enabled
1	Reverse run disabled

Multi-step speed selection

Up to 8 preset references can be selected by using Multi-Function inputs.

Example: 8-step speed reference

n02=1 (operation mode selection)

n03=1 (Frequency reference selection)

n21=25.0Hz (Frequency reference 1)

n22=30.0Hz (Frequency reference 2)

n23=35.0Hz (Frequency reference 3)

n24=40.0Hz (Frequency reference 4)

n25=45.0Hz (Frequency reference 5)

n26=50.0Hz (Frequency reference 6)

n27=55.0Hz (Frequency reference 7)

n28=60.0Hz (Frequency reference 8)

n36=2 (Multi-function contact input terminal S2)

n37=6 (Multi-function contact input terminal S3)

n38=7 (Multi-function contact input terminal S4)

n39=8 (Multi-function contact input terminal S5)



When all multi-function reference inputs are OFF, frequency reference selected by parameter n03 (frequency reference selection) becomes effective.

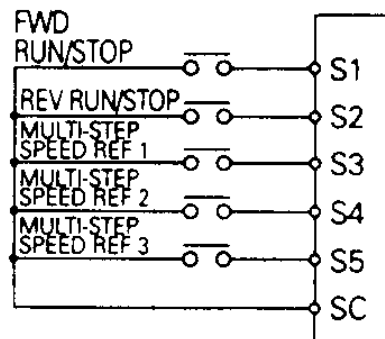

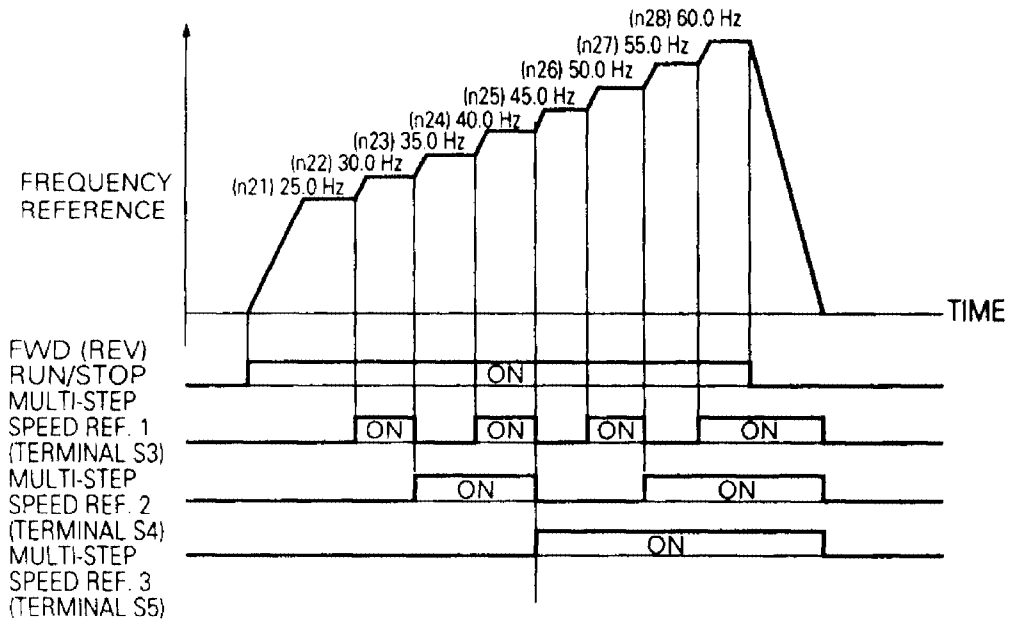

Operating at Jog frequency reference

By inputting a jog command and then a forward or (reverse) run command, operation is enabled at the jog frequency set in n29. When multi-step speed references 1, 2, 3 or 4 are input simultaneously with the jog command, the jog command has priority.

Name	parameter No.	Setting
Jog frequency reference	n29	Factory setting: 6.00Hz
Jog command	n36 to n39	Set to "10" for any parameter.

- **Adjusting speed setting signal**

The relationship between the analog input signal and internal (terminal “FR”) frequency reference can be set by parameters n41 and n42.

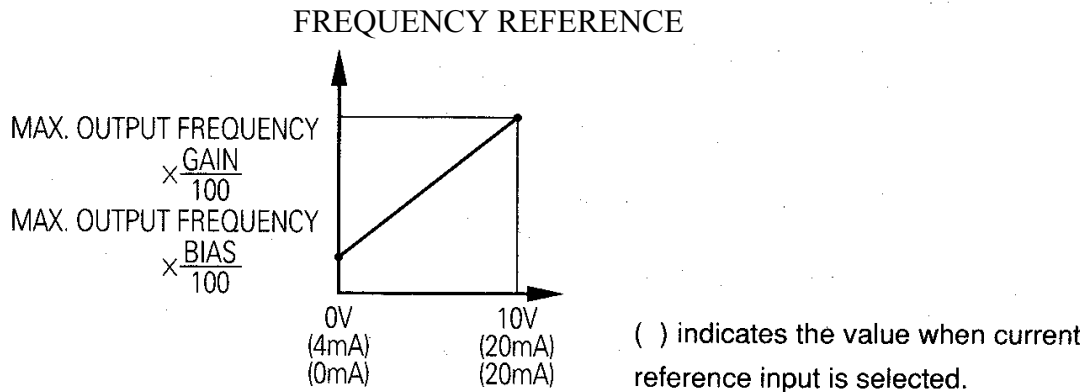

(a) Frequency reference gain (n41)

The analog input voltage level for the maximum output frequency (n09) can be set in units of 1%. (maximum output frequency n09=100%)

* Factory setting : 100%

(b) Frequency reference bias (n42)

The frequency reference provided when the analog input is 0V (4mA or 0mA) can be set in units of 1%. (Maximum output frequency n09=100%)

* Factory setting : 0%

Example settings:

- To operate the inverter with frequency reference of 0% to 100% at 0 to 5V input

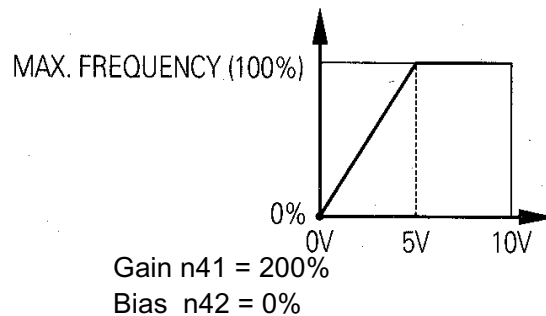

-
- To operate the inverter with frequency reference of 50% to 100% at 0 to 10V input

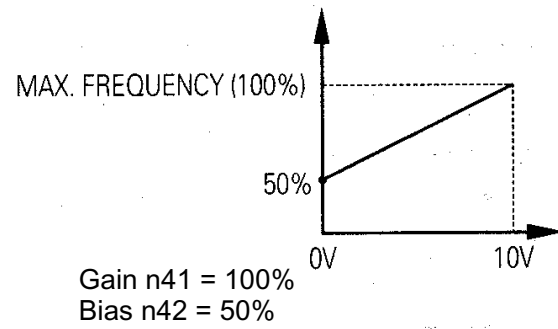

Adjusting frequency upper and lower limits

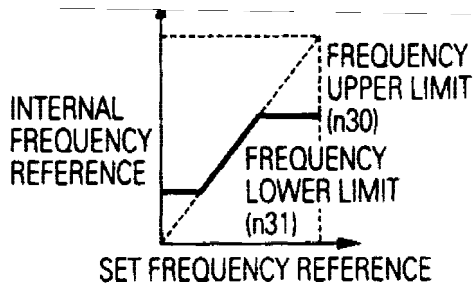

Frequency reference upper (n30) and lower (n31) limits determines the range over which the inverter will operate.

- Frequency reference upper limit (n30)**
 Sets the upper limit of the frequency reference in units of 1%.
 (n09: Maximum output frequency = 100%)
 Factory setting: 100%
- Frequency reference lower limit (n31)**
 Sets the lower limit of the frequency reference in units of 1%.
 (n09: Maximum output frequency = 100%)
 When operating at frequency reference 0, operation is continued at the frequency reference lower limit.
 However, when frequency reference lower limit is set to less than the minimum output frequency (n14), operation is not performed.
 Factory setting: 0%

Using two accel/decel times

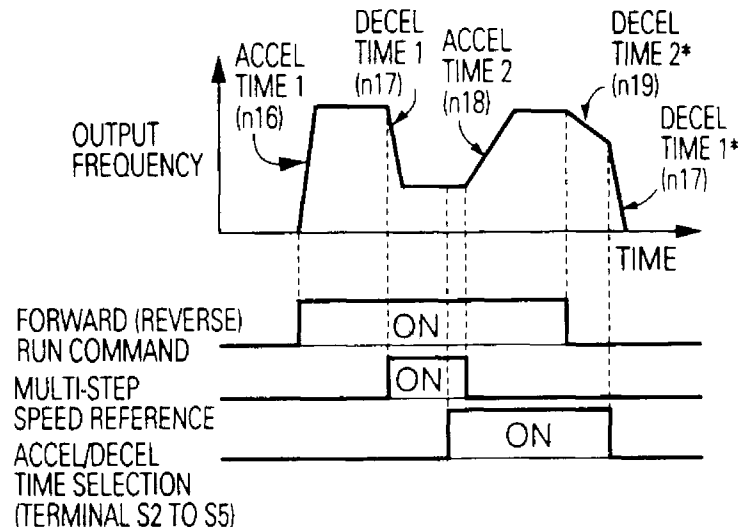

* When “deceleration to a stop” is selected (n04 = 0)

Two acceleration times and two deceleration times can be selected via a multi-function input. Programming any of terminals S2 through S5 (parameter n36 to n39) to “11” “Accel/Decel time select”, provides the ability to switch between the 2 acceleration times (n16 and n18) and deceleration (n17 and n19) through a contact closure applied to the appropriate terminal (See timing diagram above).

At OFF: n16 (accel time 1) are used.
n17 (decel time 1)

At ON: n18 (accel time 2) are used.
n19 (decel time 2)

- Accel time
Set the time needed for output frequency to reach 100% from 0%.
- Decel time
Set the time needed for output frequency to reach 0% from 100%.

(Maximum output frequency n09 = 100%)

Automatic restart after momentary power loss (n47)

The inverter has the ability to ride thru momentary power outages provided the control logic power supplies are maintained.

When momentary power loss occurs, operation restarts automatically.

Setting.	Description
0	Continuous operation after momentary power loss not provided.
1*	Continuous operation after power recovery within momentary power loss ride thru time is provided.
2*†	Continuous operation after power recovery (Fault output not provided)

* Maintain the run command to continue operation after recovery from a momentary power loss.

† When 2 is selected, operation restarts if power supply voltage reaches its normal level while control power supply is held. No fault signal is output.

Soft-start characteristics (n020)

To prevent shock at machine start/stop, accel/decel can be performed in a S-curve pattern.

Setting	S-curve characteristic time
0	S-curve characteristic not provided
1	0.2 second
2	0.5 second
3	1.0 second

Note: The S-curve characteristics time from accel/decel rate 0 to a regular accel/decel rate determined by the set accel/decel time.

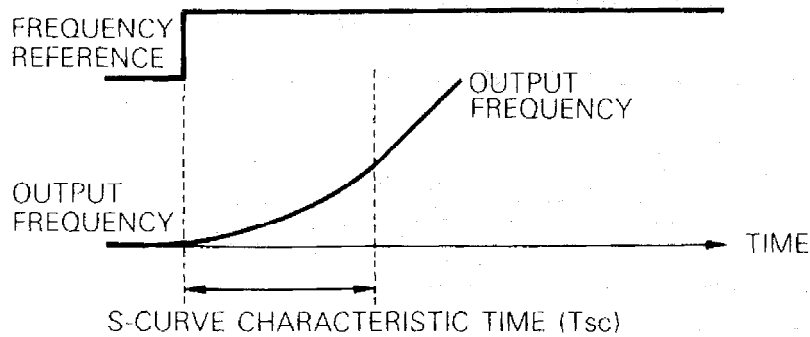

The following time chart shows FWD/REV run switching at deceleration to a stop.

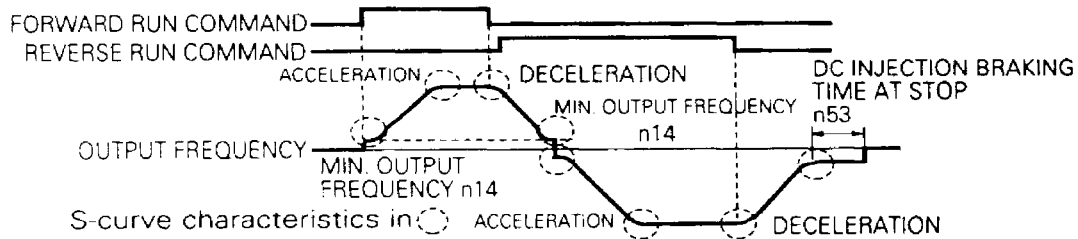

Overtorque detection

If an excessive load is applied to the machine, output current increase can be detected to output alarm signals to multi-function output terminals MA and MB.

To output an overtorque detection signal, set output terminal function selection n40 to “overtorque detection” [Setting:6 (NO contact) or 7 (NC contact)].

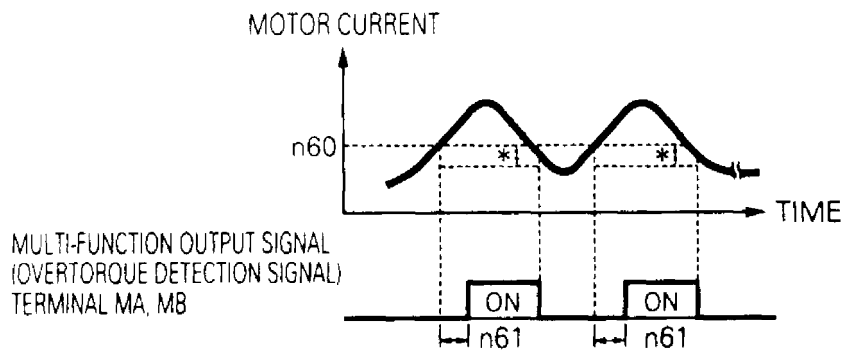

* Overtorque detection release width (hysteresis) is set at approx. 5% of inverter rated current.

- **Overtorque detection function selection (n59)**

Setting	Description
0	Overtorque detection not provided
1	Detected during speed agree, (alarm). Operation continues after detection.
2	Detected during speed agree (fault). Operation stops during detection.
3	Detected during running, operation continues after detection. (alarm).
4	Detected during running, operation stops during detection. (fault).

- (1) To detect overtorque at accel/decel, set to 3 or 4.
- (2) To continue the operation after overtorque detection, set to 1 or 3.
During detection, the operator displays “**OL3**” alarm (blinking).
- (3) To halt inverter by a fault at overtorque detection, set to 2 or 4. At detection, the operator displays “**OL3**” fault (ON).

- **Overtorque detection level (n60)**

Sets the overtorque detection current level in units of 1%. (Inverter rated current = 100%)

Factory setting: 160%

- **Overtorque detection time (n61)**

If the time when the motor current exceeds the overtorque detection level (n61), the overtorque detection function operates.

Factory setting: 0.1sec.

Frequency detection (n58)

Effective when the multi-function output terminal MA-MB-MC (parameter n40) is set to “frequency detection” (setting: 4 or 5). “Frequency detection” turns ON when output frequency is higher or lower than the frequency detection level (n58).

- Frequency detection 1 (Output frequency \geq Frequency detection level n58)
(Set n40 to “4”.)

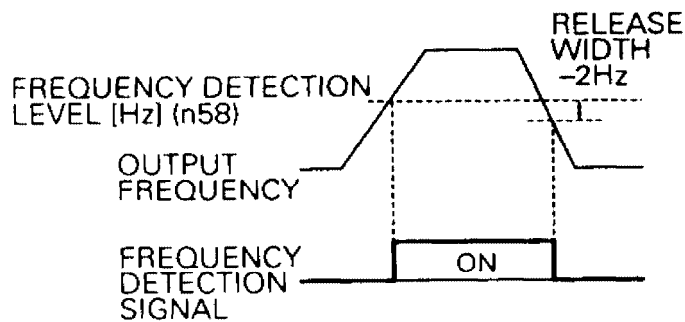

- Frequency detection2 (Output frequency \leq Frequency detection level n58)
(Set n40 to “5”.)

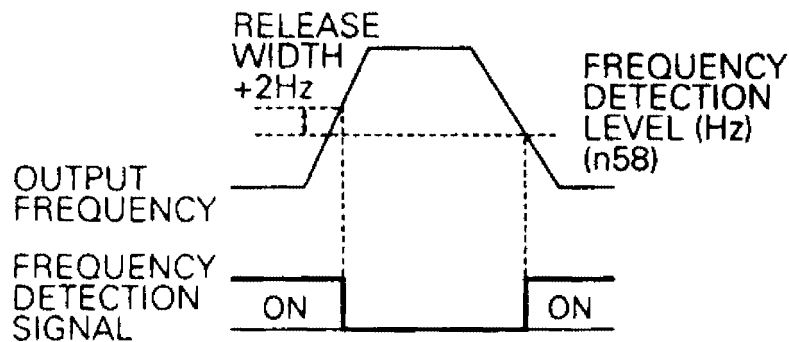

Jump frequencies (n49 to n51)

This function allows the prohibit or “jumping” of critical frequencies so that the motor can operate without resonance caused by machine characteristics. This function is also used for dead band control. Setting the value to 0.00Hz disables this function.

Set prohibited frequency 1, 2 or as follows:

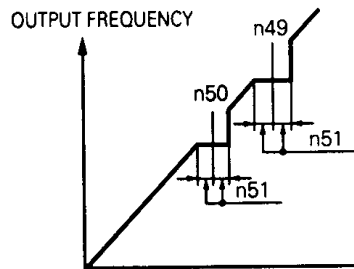

$$n49 \geq n50$$

If this condition is not satisfied the inverter displays **Err** for one second and restores the data to original settings.

Continuous operation is prohibited within the jump frequency range.

However, during accel/deccl the output frequency ramps through the jump frequency range (without jumping).

Continuing operation by automatic fault reset (n48)

Sets the inverter to restart and reset fault detection after a fault occurs.

The number of self-diagnosis and retry attempts can be set with n48 (0 thru 10 restarts).

The inverter will automatically restart after the following faults occur:

- OC (overcurrent)
- GF (ground fault)
- OV (over voltage)

The number of retry attempts are cleared to 0 during the following cases:

- (1) If no other fault occurs within 10 minutes after retry
- (2) When the fault reset signal is ON after the fault is detected
- (3) Input power is turned OFF

Starting into a rotating motor - Tripless Operation

To start into a coasting motor without trip, use the speed search command or DC injection braking at start.

- **Speed search command**

Speed matches into a coasting motor upon starting without stopping the motor. This function enables smooth switching between motor commercial power supply operation and inverter operation.

Set input terminal function selection (n36 to n39) to “14” (search command from maximum output frequency) or “15” (search command from set frequency).

Build a sequence so that FWD (REV) run command is input at the same time as the search command or after the search command. If the run command is input before the search command, the search command becomes disabled.

- **Time chart at search command input**

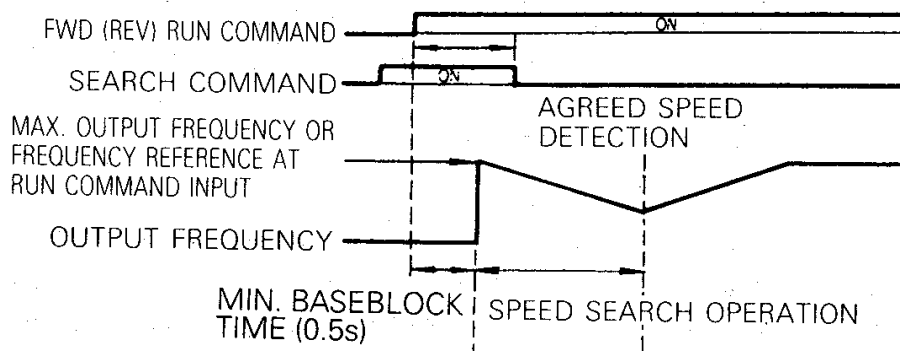

- **DC injection braking at start (n52, n54)**

When starting into a coasting motor, use DC injection to gradually brake the motor before beginning the acceleration ramp. Set the DC injection braking time at start in n54 in units of 0.1 second. Set DC injection braking current in n52 in units of 1% (inverter rated current = 100%). When the setting of n54 is “0”, DC injection braking is not performed and acceleration starts from the minimum output frequency.

When n52 is set to 0, acceleration starts from the minimum output frequency after base blocking for n54 setting time.

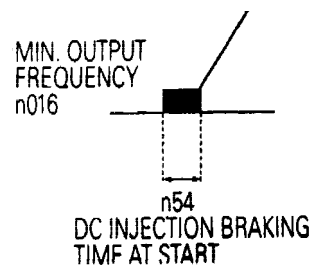

Accel/Decel Hold

To hold acceleration or deceleration, use a multi-function input that is set to a value of “16: Accel/Decel Hold. The output frequency is kept constant when the accel/decel hold command is input during acceleration or deceleration.

When the run command is removed during an accel/decel hold condition, accel/decel hold is internally released and operation ramps to stop.

Set multi-function input terminal selection (n36 to n39) to 16 (accel/decel hold command).

Time chart at accel/decel hold command input

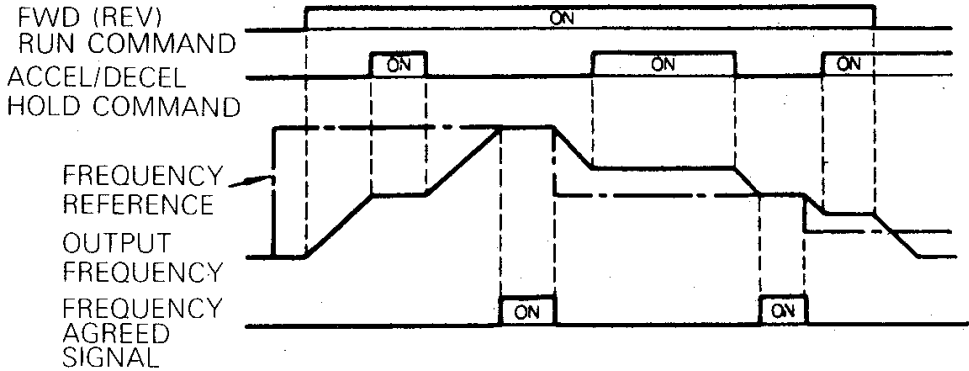

Note: When the FWD (REV) run command is input along with the accel/decel hold command, the motor does not operate. However, when frequency reference lower limit (n31) is set greater than or equal to minimum output frequency (n14), the motor operates at frequency reference lower limit (n31).

Using a frequency meter or ammeter (n44)

Determines whether output frequency or output current is indicated on the analog output terminals, AM-AC, for monitoring.

Setting	Description
0	Output frequency
1	Output current

Initial setting-analog voltage of approx. 10V is output when output frequency (output current) is 100%.

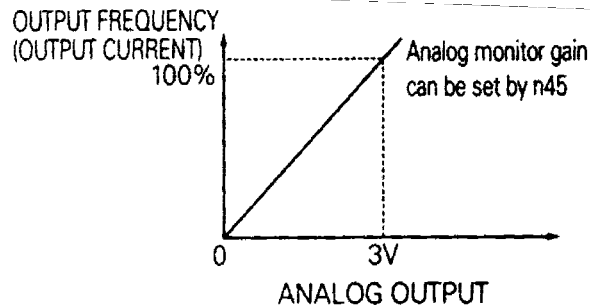
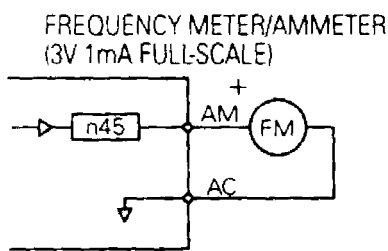

Calibrating frequency meter or ammeter (n045)

Used to adjust analog output gain.

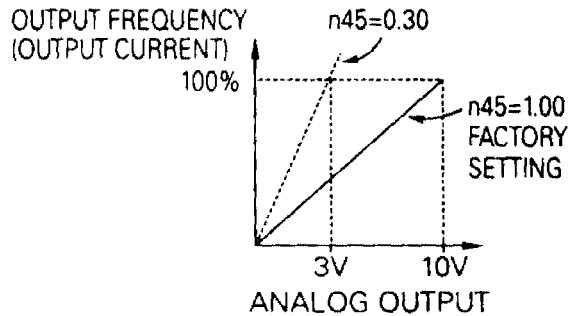
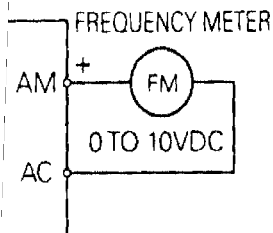

Scales the analog output voltage signal level at 100% of output frequency (output current).

Example: Frequency meter displays 0 to 60Hz with 0 to 3V.

$10V \times n45 \text{ setting } (0.30V) = 3V$ (3V is output at 100% output frequency)

Reducing motor noise leakage current (n46)

Set inverter output transistor switching frequency (carrier frequency).

Setting	Carrier Frequency (kHz)	Audible Noise from Motor	RFI Noise and Current Leakage
7	12 f _{out} (Hz)	Higher ↑ ↓ Not audible	Smaller ↑ ↓ Larger
8	24 f _{out} (Hz)		
9	36 f _{out} (Hz)		
1	2.5 (kHz)		
2	5.0 (kHz)		
3	7.5 (kHz)		
4	10.0 (kHz)		

Setting values 7, 8, or 9 provides a synchronous carrier frequency that changes with output frequency as follows.

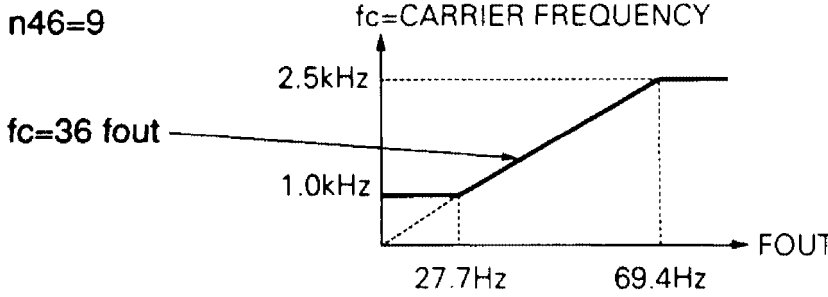
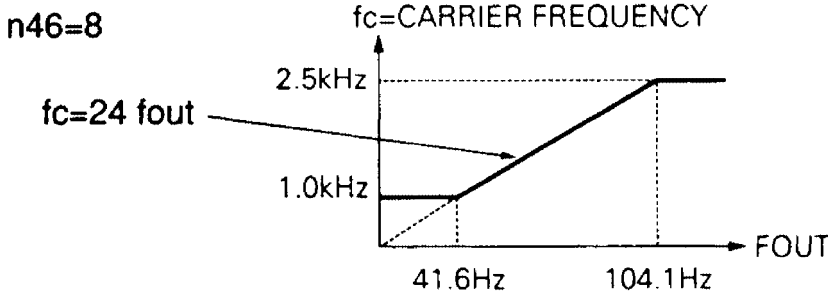
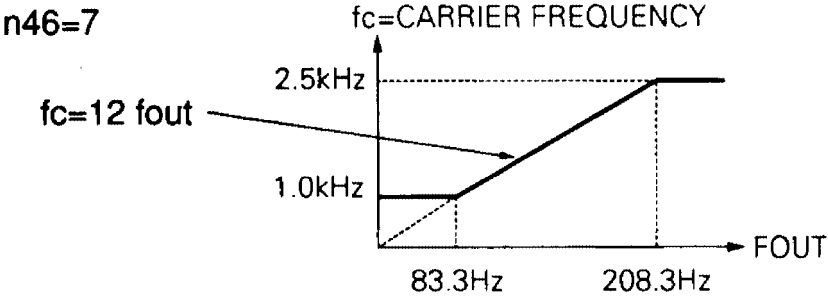

Carrier Frequency Varies According to Inverter Capacity (kVA).

Voltage Class	Capacity hp(kW)	Initial Setting		Maximum Continuous Output Current (A)	Reduced Current (A) *1
		Setting	Carrier Frequency		
200V Single-phase 3-phase	0.13 (0.1)	4	10kHz	0.8	-
	0.25 (0.2)	4	10kHz	1.6	
	0.5 (0.4)	4	10kHz	3.0	
	1 (0.75)	4	10kHz	5.0	
	2 (1.5)	3	7.5kHz	8.0	7.0
	3 (2.2)	3	7.5kHz	11.0	10.0
	5 (3.7)	3	7.5kHz	17.5	16.5
400V 3-phase	0.25 (0.2)	3	7.5kHz	1.2	1.0
	0.5 (0.4)	3	7.5kHz	1.8	1.6
	1 (0.75)	3	7.5kHz	3.4	3.0
	2 (1.5)	3	7.5kHz	4.8	4.0
	3 (2.2)	3	7.5kHz	5.5	4.8
	4 (3.0)	3	7.5kHz	7.2	6.3
	5 (3.7)	3	7.5kHz	9.2	7.6



(1) Reduce continuous output current by changing carrier frequency to a setting of 4 (10 kHz) for 200V class inverters (size $\geq 1.5\text{kW}$) and all 400V class inverters. Refer to the table above for the reduced current.

[Operation Condition]

- Input power supply voltage: 3-phase 200 to 230V (200V class)
Single-phase 200 to 240V (200V class)
3-phase 380 to 460V (400V class)
- Ambient temperature: 14 to 122 °F (-10 to +50°C)

(2) If the wiring distance is long (approx. 50 meters), reduce the inverter carrier frequency as described below.

Wiring Distance between Inverter and Motor	Up to 50m	Up to 100m	More than 100m
Carrier frequency (n46 setting)	10kHz or less (n46=1, 2, 3, 4, 7, 8, 9)	5kHz or less (n46=1, 2, 7, 8, 9)	2.5kHz or less (n46=1, 7, 8, 9)

(3) Carrier frequency can be automatically reduced to 2.5 kHz when (n75) is set to 1 and the following conditions are satisfied.

Output frequency $\leq 5\text{Hz}$

Output frequency $\geq 100\%$

Factory Setting (n75) is 0 (disabled)

Operator stop key selection (n06)

Selects whether the “STOP” key on the digital operator is effective when operating the inverter by an external source (input terminals or serial communications).

Setting	Description
0	STOP key effective when running either from multi-function input terminals or communications. When STOP key is pressed, the inverter stops according to the setting of parameter n04. At this time, the digital operator displays “ <i>SrP</i> ” alarm (blinking). This stop command is held in the inverter until both forward and reverse run commands are open, or until run command from communications becomes zero.
1	STOP key is ineffective when running either from multi-function input terminals or communications.

• Selecting Stopping Method

Selecting stopping method (n04)

Selects the stopping method when the run command is removed.

Setting	Description
0	Deceleration to stop
1	Coast to stop

• Deceleration to stop (n04 =0)

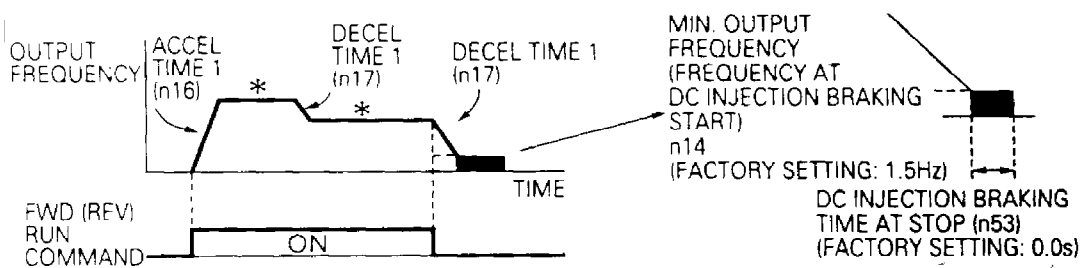

* When frequency reference is changed during running.

Upon removal of the FWD (REV) run command, the motor decelerates at the decel rate determined by the time set to decel time 1 (n17) and DC injection braking is applied immediately before stop. DC injection braking is also applied when the motor decelerates by setting the frequency reference lower than minimum output frequency while the(n14) with FWD (REV) run command remains ON.

If the decel time is short or the load inertia is large, an over voltage (OV) fault may occur during deceleration. In this case, increase the decel time.

- Coast to stop (n04=1)

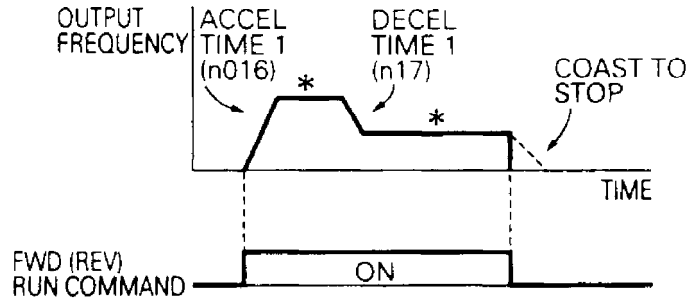

* When frequency reference is changed during running.

Upon removal of the FWD (REV) run command, the motor starts coasting.

Applying DC injection braking

- DC injection braking current (n52)
Sets DC injection braking current level in units of 1%. (Inverter rated current=100%)
- DC injection braking time at stop (n53)
Sets the DC injection braking time at stopping in units of 0.1 second. When the setting of n53 is 0, DC injection braking is not performed but inverter output is shut OFF at the timing of DC injection braking start.

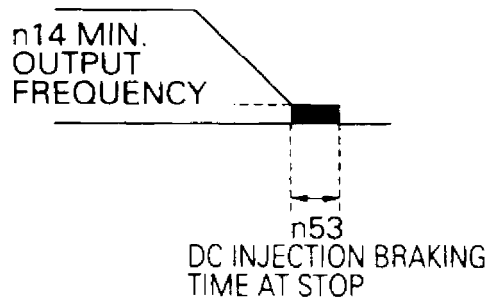

When coast to a stop is selected as the stopping method selection (n04), DC injection braking at stop does not operate.

• Building Interface Circuits with External Devices

Using input signals

Multi-function input terminal S2 to S5 functions can be changed when necessary by setting parameters n36 thru n39 respectively. Parameters n36 thru n39 cannot be set to the same value.

Setting	Name	Description	Ref.
0	FWD/REV run command (3 wire sequence selection)	Setting enabled only for n37	85
2	Reverse run (2 wire sequence selection)		65
3	External fault (NO contact input)	Inverter stops by external fault signal input Digital operator display is EF□*.	–
4	External fault (NC contact input)		–
5	Fault Reset	Resets the fault. Fault reset not effective with the run signal ON.	75
6	Multi-step speed reference 1		65
7	Multi-step speed reference 2		65
8	Multi-step speed reference 3		65
10	JOG command		66
11	Accel/Decel time select		69
12	External baseblock (NO contact input)	Motor coast to a stop by this signal input. Digital operator display is bb	–
13	External baseblock (NC contact input)		–
14	Search command from maximum frequency	Speed search reference signal	76
15	Search command from set frequency		76
16	Accel/decel hold command		77
17	LOCAL/REMOTE selection		61
18	Communication/control circuit terminal selection		87
19	Emergency stop fault (NO contact input)	Inverter stops by emergency stop signal input according to stopping method selection (n04). When frequency coasting to a stop (n04 is set to 1) method is selected, inverter coasts to a stop according to decel time setting 2 (n19). Digital operator display is Srp (lit at fault, blinking at alarm).	–
20	Emergency stop alarm (NO contact input)		–
21	Emergency stop fault (NC contact input)		–
22	Emergency stop alarm (NC contact input)		–
34	UP/DOWN command	Setting enabled only for n39 (terminal S5)	86
35	Self-test	Setting enabled only for n39 (terminal S5)	–

* Numbers 2 to 5 is displayed in □ corresponding to the terminal numbers S2 to S5 respectively.

Fault Reset

Fault reset is not effective with the run signal ON.

No.	Terminal	Initial Setting
n36	S2	2
n37	S3	5
n38	S4	3
n39	S5	6

Terminal function at 3-wire sequence selection

When 0 is set at the terminal S3 (n37), terminal S1 becomes run command, terminal S2 becomes stop command, and terminal S3 becomes FWD/REV run command.

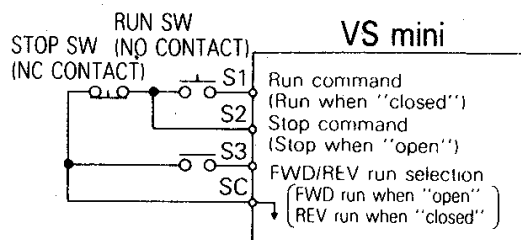

- **LOCAL/REMOTE select (setting: 17)**
 Select operation reference either by the digital operator or by the settings of operation method selection (n02) and frequency reference selection (n03). LOCAL/REMOTE select is available only during stop.

Open: Run according to the setting of run command selection (n02) or frequency reference selection (n03)

Closed: Run by frequency reference and run command from the digital operator.

Example: Set n02 = 1, n03 = 2, n07 = 0.

Open: Run by frequency reference from multi-function input terminal FR and run command from multi-function input terminals S1 to S7.

Closed: Run by volume frequency reference and run command from the digital operator.
- **UP/DOWN command (setting: 34)**
 With the FWD (REV) run command entered, accel/decel is initiated by inputting the UP or DOWN commands to multi-function input terminals S4 and S5. Closing the S4 input will cause the output frequency to increase. Closing the S5 input will cause the output frequency to decrease (as indicated in the following table. When UP/DOWN commands are specified by n39, any function set to n38 becomes disabled; terminal S4 becomes an input terminal for the UP command and terminal S5 for the DOWN command.

Multi-function Input Terminal S4 (UP command)	Closed	Open	Open	Closed
Multi-function Input Terminal S5 (DOWN command)	Open	Closed	Open	Closed
Operation Status	Accel	Decel	Hold	Hold

Time Chart at UP/DOWN Command Input

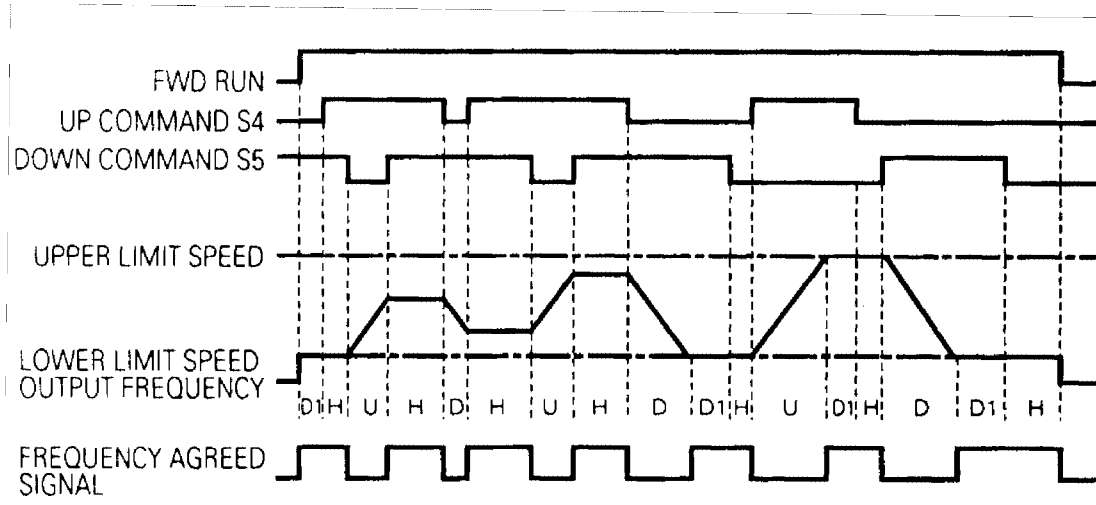

Notes:

- (1) When UP/DOWN command is selected, the upper limit speed is set regardless of frequency reference.

$$\text{Upper limit speed} = \text{Maximum output frequency (n09)} \times \text{Frequency reference upper limit (n030)}/100$$
- (2) Lower limit value is either minimum output frequency (n14) or Maximum output frequency (n09) x frequency reference lower limit (n31)/100% (whichever is greater).
- (3) When the FWD (REV) run command is input, operation starts at the lower limit speed without an UP/DOWN command.
- (4) If the jog command is input while running by the UP/DOWN command, the jog command has priority.
- (5) Multi-step speed reference 1 to 3 is not effective when UP/DOWN command is selected. Multi-step speed reference is effective during running in hold status.
- (6) When "1" is set for HOLD output frequency memory selection (n62), output frequency can be recorded during HOLD.

Setting	Description
0	Output frequency is not recorded during HOLD.
1	When HOLD status is continued for 5 seconds or longer, the output frequency during HOLD is recorded and the inverter restarts at the recorded frequency.

- **Communication/multi-function input terminal selection input (setting: 18)**
(This function is effective when option card is installed)
Operation can be changed from communication command, or from multi-function input terminal or digital operator command.
Run command and frequency reference from communication options are effective when multi-function input terminal for this setting is “closed.”
Run command and frequency reference in LOCAL/REMOTE mode are effective when “Open.”

Using output signals (n40)

Multi-function output terminal MA and MB functions can be changed when necessary by setting parameter n40.

- Terminal MA and MB functions: Set to n40

Setting	Name	Description	Ref page
0	Fault	Closed when inverter fault occurs.	–
1	Inverter Run	Closed when either FWD/REV command is input or voltage is output from the inverter.	–
2	Agreed frequency	Closed when setting frequency agrees with inverter output frequency.	88
3	Zero speed	Closed when inverter output frequency is less than minimum output frequency.	–
4	Frequency detection	Output frequency \geq frequency detection level (n58)	74
5	Frequency detection	Output frequency \leq frequency detection level (n58)	74
6	Overtorque detection (NO contact output)	—	73
7	Overtorque detection (NC contact output)	—	73
10	Minor Fault	Closed when the alarm is indicated.	–
11	Base blocked	Closed when the inverter output is shut off.	–
12	Operation mode	Closed when “LOCAL” is selected by LOCAL/REMOTE selection.	–
13	Inverter ready	Closed when inverter fault is not detected, and operation is ready.	–
14	Fault restart	Closed during fault retry	–
15	In UV	Closed when undervoltage is detected.	–
16	In reverse run	Closed during reverse run.	–
17	In speed search	Closed when inverter conducts speed search.	–
18	Data output from communication	Operates multi-function output terminal independently from inverter operation (by MEMOBUS communication).	–

Initial setting of multi-function output terminal

No.	Terminals	Initial Setting
n40	MA, MB	1 (Inverter Run)

• Frequency agreed signal (setting=2)

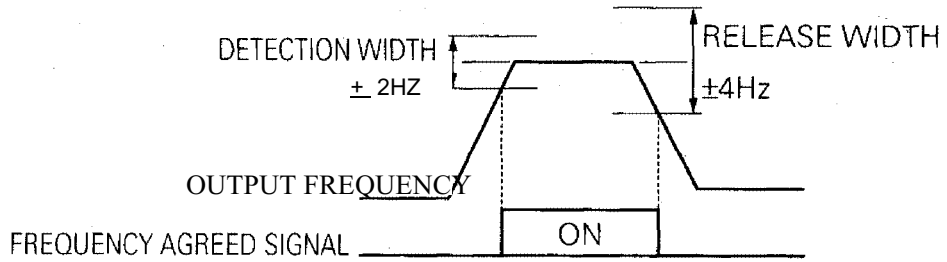

- **Setting Frequency by Current Reference Input**

When setting frequency by inputting current reference (4-20mA or 0-20mA) from the control circuit terminal FR, switch the DIP switch SW8 on the control circuit board to “I” side.

SW8 is accessed by removing the terminal cover.

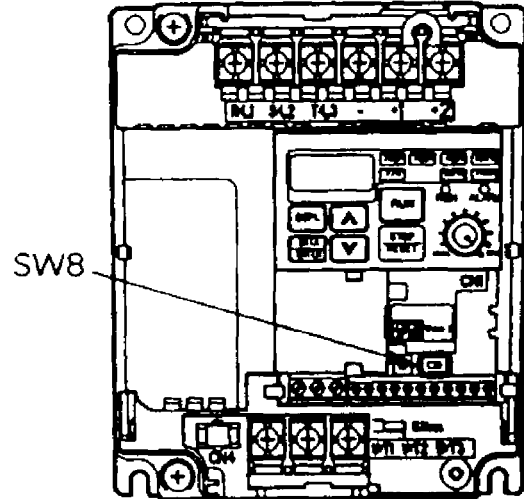
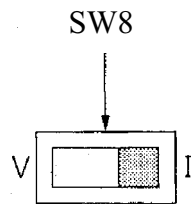

Never input voltage reference to control circuit terminal FR when DIP switch SW8 is switched to “I” side. Damage to the inverter may result.

Current reference selection

After changing DIP switch (SW8) to the “I” side, PRESS **PRGM** on the digital operator, then set the following parameters.

4-20mA...n03 = 3

0-20mA...n03 = 4

- Setting : n02 = 0, n03 = 3 or 4

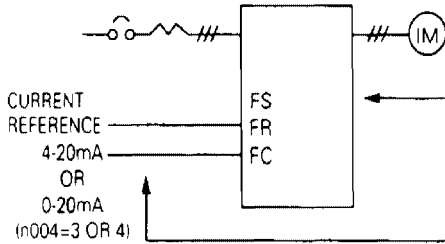

- Setting : n02 = 1, n03 = 3 or 4

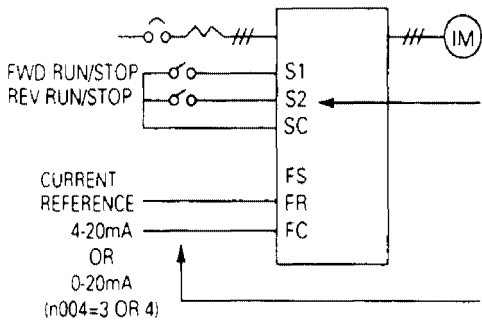

Press the digital operator keys to run or stop the inverter. Switch run and stop direction by setting F/R LED.

Set frequency by the analog current signal [0-100% (max frequency)/4-20mA or 0-20mA] connected to the control circuit terminal.

Set run/stop and FWD/REV run with switching device connected to the control circuit terminal.

Multi-function input terminal S2 is set to Reverse run/stop (n36 = 2).

Set frequency by the analog current signal [0-100% (max. frequency)/4-20mA or 0-20mA] connected to the control circuit terminal.

Frequency reference gain (n41)/bias (n42) can be set even when current reference input is selected. For details, refer to “Adjusting speed setting” on page 69.

• Preventing Motor from Stalling (Current Limit)

This function automatically limits the output current in response to load changes by adjusting the output frequency to prevent motor stalling.

- **Stall prevention (current limit) level during acceleration (n56)**

Sets the stall prevention (current limit) level during acceleration in units of 1% (Inverter rated current = 100%).

Factory setting: 170%

A setting of 200% disables the stall prevention (current limit) during acceleration. During acceleration, if the output current exceeds the value set for n56, acceleration stops and frequency is maintained. When the output current goes down to the value set for n56, acceleration continues.

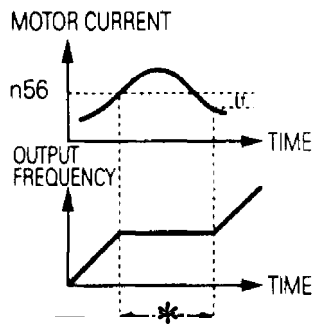

* Stops the acceleration to prevent the motor from stalling.

† Release width (hysteresis) of stall prevention during accel is approx. 5% of inverter rated current.

In the constant horsepower area [output frequency > max. voltage output frequency (n11)], following equation automatically decreases the stall prevention (current limit) level during acceleration.

Stall prevention (current limit) level* during accel in constant output area

$$= \frac{\text{Stall prevention (current limit) level during accel (n56)}}{\text{Output frequency}} \times \text{Max. voltage output frequency (n11)}$$

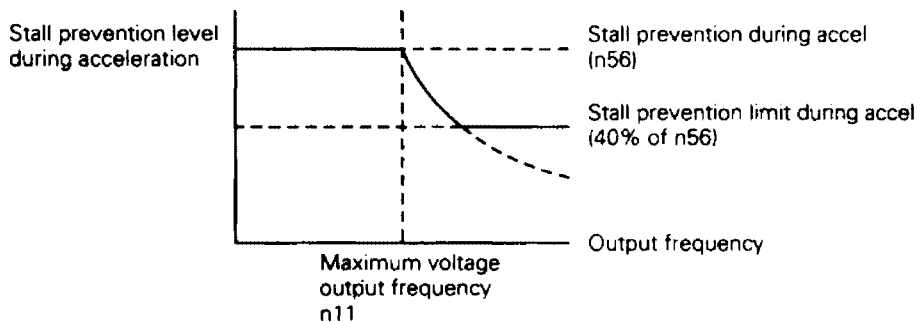

*Note: The lower limit of the stall prevention level is 40% of the level set in n56.

- **Stall prevention (current limit) level during running (n57)**

Sets the stall prevention (current limit) level during running in units of 1% (Inverter current = 100%).

Factory setting: 160%

A setting of 200% disables the stall prevention (current limit) during running.

If the output current during speed agree exceeds the value set for n57 for longer than 100msec, deceleration starts.

As long as the output current exceeds the value set for n57 deceleration continues.

When the output current goes below the value set for n57, acceleration begins to the set frequency.

The accel/decel rates during stall prevention are determined by the accel time (n16 or n18) and decel time (n17 or n19) that is selected at the time of the stall prevention condition.

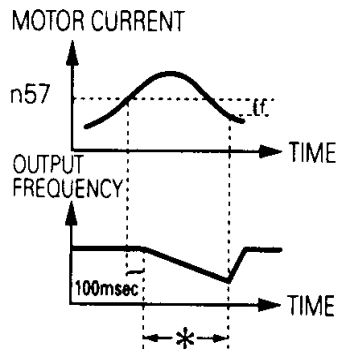

* Decreases frequency to prevent the motor from stalling.

† At acceleration start, output hysteresis is approx. 5% of inverter rated current.

- **Stall prevention (current limit) function during deceleration (n55)**

To prevent overvoltage during deceleration, the inverter automatically lengthen the deceleration time according to the value of main circuit DC voltage.

Setting	Stall prevention (current limit) during deceleration
0	Provided
1	Not Provided

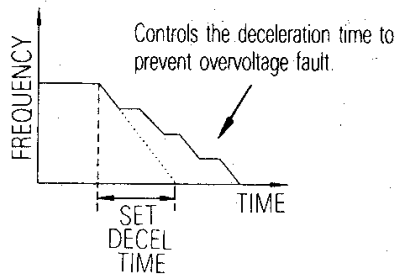

• Decreasing Motor Speed Fluctuation

Slip compensation

As the load becomes larger, rotor speed is reduced as motor slip increases. The slip compensating function regulates the motor shaft speed as the load increases by increasing the output frequency.

When inverter output current is equal to the motor rated current (n32), the compensation frequency is added to the output frequency.

Compensation frequency = Motor rated slip (n64)

$$\times \frac{\text{Output current} - \text{Motor no-load current } n65}{\text{Electronic thermal reference current } (n32) - \text{Motor no-load current } (n65)}$$

$$\times \text{Slip compensation gain } (n66)$$

Parameters

Parameters No.	Name	Unit	Setting Range	Initial Setting
n032	Motor rated current	0.1A	0 to 120% of inverter rated current	*
n64	Motor rated slip	0.1Hz	0.0 to 20Hz	*
n65	Motor no-load current	1%	0 to 99% (100% = Motor rated current n32)	*
n66	Slip compensation gain	0.1	0.0 to 2.5	0.0
n67	Slip compensation primary delay time	0.1s	0.0 to 25.5s When 0.0s is set, delay time becomes 2.0s	2.0s

* Differs depending on inverter capacity.

Notes: 1. Slip compensation is not performed in the following condition:

Output frequency < minimum output frequency (n14).

2. Slip compensation is not performed during regeneration.

3. Slip compensation is not performed when motor rated current (n32) is set to 0.0A.

- **Motor Protection**

Motor overload detection

Built-in electronic thermal overload protection is provided to protect against motor overheating.

- **Motor rated current (electronic thermal reference current, n32)**
Set to the rated current value shown on the motor nameplate.
- **Motor overload protection selection (n33, n34).**

n33 Setting	Electronic Thermal Characteristics
0	Applied to general-purpose motor (limited speed range)
1	Applied to inverter duty motor (wide speed range)
2	Electronic thermal overload protection not provided

Parameters No.	Name	Unit	Setting Range	Initial Setting
n34	Protection parameter selection	1min	1 to 60min	8min

The electronic thermal overload function calculates motor temperature, based on inverter output current and time, to protect the motor from overheating. When the electronic thermal overload relay is enabled and excessive current is flowing to the motor, an “ OL ” error occurs, shutting OFF the inverter output and preventing excessive overheating in the motor. When operating with one inverter connected to one motor, an external thermal relay is not needed. When operating several motors with one inverter, install a thermal relay on each motor and disable the electronic overload protection (n33=2).

- General-purpose motor and inverter motor

Induction motors are classified as general-purpose motors (limited speed range) or inverter motors (wide speed range), based on their cooling capabilities. Therefore, the motor overload function operates differently between these two motor types.

Example of 200V class motor

	Cooling Effect	Torque Characteristics	Electronic Thermal overload
General-purpose Motor	Effective when operated at 50/60Hz from commercial power supply	<p>Base Frequency 60Hz (V/f for 60Hz, 220V Input Voltage)</p> <p>For low-speed operation, torque must be limited in order to stop motor temperature rise.</p>	OL1 error (motor overload protection) occurs when continuously operated at 50/60Hz or less at 100% load.
Inverter Duty Motor	Effective even when operated at low speed (approx. 6Hz)	<p>Base Frequency 60Hz (V/f for 60Hz, 220V Input Voltage)</p> <p>Use an inverter duty motor for continuous operation at low speed.</p>	Electronic thermal overload protection not activated even when continuously operated at 50/60Hz or less at 100% load.

- **Selecting Cooling Fan Operation**

In order to increase fan life, the cooling fan can be set to operate when inverter is running or when power is supplied.

- n35 = 0 (factory setting) : Operates only when inverter is running.
(Continues operation for 1 minute after inverter is stopped.)
- = 1 : Operates while power is ON.

- **Using MEMOBUS (MODBUS) Communications**

Serial transmission is available with VS mini J7 using programmable controller (MEMOCON series) and MEMOBUS. In order to perform serial communications, RS-485/422 interface card (optional) must be installed.

- **MEMOBUS (MODBUS) communications**

MEMOBUS system is composed of a single master (PLC) and slaves (1 to 31 VS-mini units).

Transmission between master and slave (serial communication) is controlled according to the master program with the master initiating communication and the slave responding.

The master sends a signal to one slave at a time. Each slave has a pre-registered address No., and the master specifies the number and conducts signal communication. The slave receives the transmission to carry out designated functions and reply to the master.

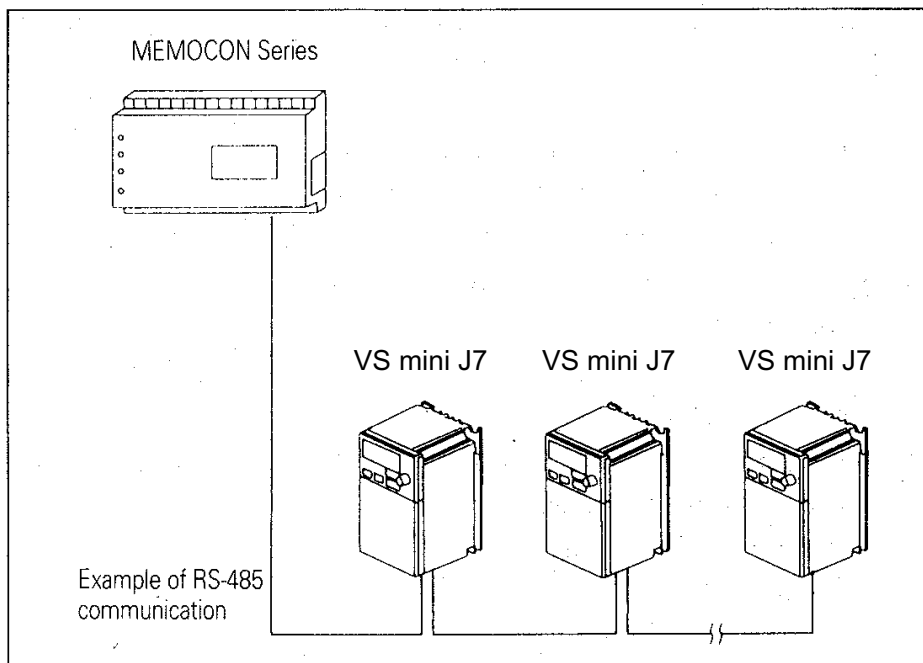

- **Communications specifications**

Interface	RS-422, RS485
Synchronization	Asynchronous (Start-stop synchronization)
Communication parameters	Baud rate: Selected from 2400/4800/9600/19200 bps Data length: 8 bits fixed Parity: Selected from even/odd/none Stop bits: 1 bit fixed
Communication protocol	MEMOBUS (MODBUS) (RTU mode only)
Max. number of inverters that can be connected	31 units (When using RS-485)

Notes

8. Maintenance and Inspection

• Periodical Inspection

Periodically inspect the inverter as described in the following table to prevent accidents and to ensure high performance with high-reliability.

Location to Check	Check For	Solution
Terminal, unit mounting screws, etc.	Connection hardware is properly seated and securely tightened.	Properly seat and tighten hardware.
Cooling fins	Built up dust, dirt, and debris	Blow with dry compressed air: 39.2 X 10 ⁴ to 58.8 X 10 ⁴ Pa, 57 to 85 psi (4 to 6kg / cm ²) pressure.
Printed circuit board	Accumulation of conductive material or oil mist	Blow with dry compressed air: 39.2 X 10 ⁴ to 58.8 X 10 ⁴ Pa, 57 to 85 psi (4 to 6kg / cm ²) pressure. If dust or oil cannot be removed, replace the inverter unit.
Power elements and smoothing capacitor	Abnormal odor or discoloration	Replace the inverter unit.
Cooling fan	Abnormal noise or vibration. Cumulative operation time exceeding 20,000 hours.	Replace the cooling fan.

• Part Replacement

Inverter's maintenance periods are noted below. Keep them as reference.

Part Replacement Guidelines

Part	Standard Replacement Period	Replacement Method
Cooling fan	2 to 3 years	Replace with new part.
Smoothing capacitor	5 years	Replace with new part. (Determine need by inspection).
Breaker relays	—	Determine need by inspection.
Fuses	10 years	Replace with new part.
Electrolytic capacitors on PCBs	5 years	Replace with new board. (Determine need by inspection).

Note: Usage conditions are as follows:

- Ambient temperature: Yearly average of 30°C.
- Load factor: 80% max.
- Operating rate: 12 hours max. per day.

Replacement of cooling fan

• Inverter having W-dimension (width) 2.68 inches (68mm)

1. Removal

- (1) Press the right and left tabs of the fan cover inward (direction 1), and then pull them outward (direction 2) to remove the fan assembly from the inverter unit.
- (2) Carefully pull the wiring in (direction 3) from the fan cover rear face, and remove the protective tube and connector.
- (3) Open the left and right sides of the fan cover to remove the cooling fan from the cover.

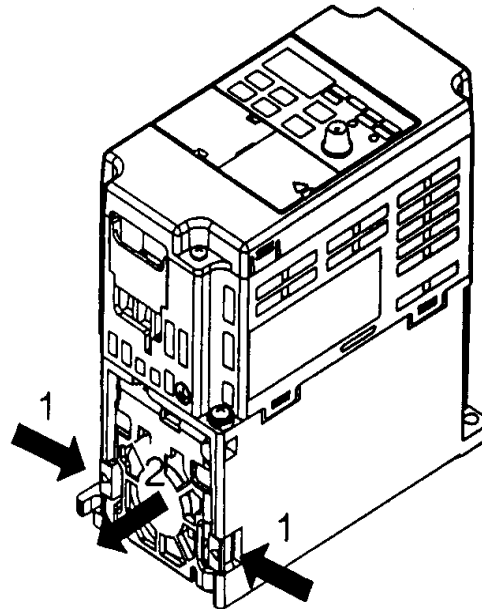

2. Mounting

- (1) Mount the cooling fan to the fan cover. The arrow indicating the air flow direction of the cooling fan must be pointing away from the cover.
- (2) Connect the connector and mount the protective tube firmly. Mount the connector joint section on the fan cover rear face.
- (3) Mount the fan cover on the inverter. Be sure to snap-in the right and left tabs of the fan cover on the cooling fin.

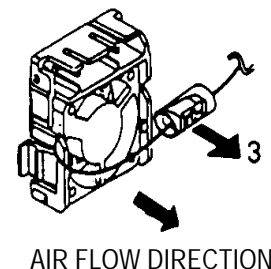

- **Inverter having W-dimension (width) 108mm (4.25 inches)**

1. Removal

- (1) Remove the front cover and terminal cover, and then remove the cooling fan connector (CN10).
- (2) Press the right and left tabs of the fan cover inward (direction 1), and pull the fan cover downward (direction 2) to remove it from the inverter unit. Pull out the wiring from the cable lead-in hole at the bottom of the plastic case.
- (3) Open the right and left sides of the fan cover to remove the cover from the cooling fan.

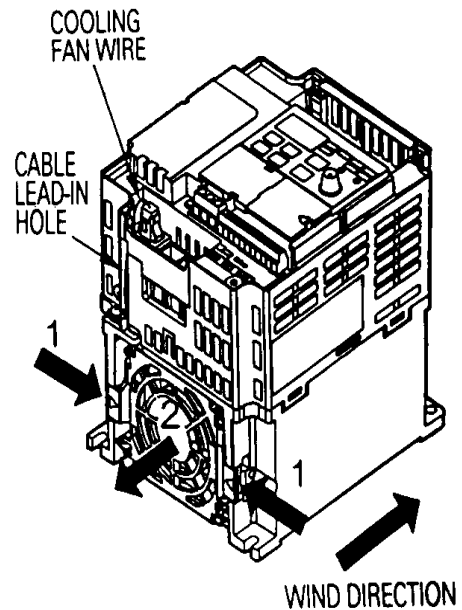

2. Mounting

- (1) Mount the cooling fan to the fan cover. The arrow mark indicating the air flow direction must point away from the cover.
- (2) Mount the fan cover on the inverter. Be sure to snap-in the right and left tabs of the fan cover on the cooling fin. Lead in the wiring from the cable lead-in hole at the bottom of the plastic case to the inside of the inverter.
- (3) Connect the wiring to the cooling fan connector (CN10) and mount the front cover and the terminal cover.

NOTES

9. Fault Diagnosis and Corrective Actions

This section describes the alarm and fault displays, explanations for fault conditions and corrective actions to be taken if the VS mini J7 malfunctions.

< Corrective Actions for models without digital operator >

1. Input fault reset or cycle the power supply OFF and ON.
2. When a fault cannot be corrected:
 - Turn the power supply OFF and check the wiring and control logic.





< Corrective Actions of Models with Digital Operator >





 : ON



 : Blinking

 : OFF

Alarm Display and Contents

Alarm Display		Inverter Status	Explanation	Causes and Corrective Actions
Digital Operator	RUN (Green) ALARM (Red)			
 Blinking		Warning Fault contacts do not change state.	UV (Main circuit low voltage) Main circuit DC voltage drops below the low-voltage detection level while the inverter output is OFF. 200V: Main circuit DC voltage become lowered below approx. 200V (160V for single phase) 400V: Main circuit DC voltage become lowered below approx. 400V.	Check the following: <ul style="list-style-type: none"> • Power supply voltage • Main circuit power supply wiring is connected. • Terminal screws are securely tightened.
 Blinking			OV (Main circuit over voltage) Main circuit DC voltage exceeds the over voltage detection level while the inverter output is OFF. Detection level: approx. 410V or more (approx. 820V for 400V class).	Check the power supply voltage.
 Blinking			OH (Cooling fin overheat) Intake air temperature rises while the inverter output is OFF.	Check the intake air temperature.
 Blinking			CAL (MEMOBUS communications waiting) Correct data has not been received from the PLC when the parameters n02 (operation command selection) is 2 or n03 (frequency reference selection) is 6, and power is turned ON.	Check communication devices and transmission signals.

Alarm Display			Inverter Status	Explanation	Causes and Corrective Actions
Digital Operator	RUN (Green)	ALARM (Red)			
<p>OP □</p> <p>Blinking</p>	 	<p>Warning</p> <p>Fault contacts do not change state.</p>	<p>OP□ (parameters setting error when the parameters setting is performed through the MEMOBUS communications)</p> <p>OP1: Two or more values are set for multi-function input selection. (parameters n36 to n39)</p> <p>OP2: Relationship among V / f parameters is not correct. (parameters n09, n11, n12, n14)</p> <p>OP3: Setting value of motor rated current exceeds 120% of inverter rated current. (parameter n32)</p> <p>OP4: Upper/lower limit of frequency reference is reversed. (parameters n30, n31)</p> <p>OP5: Setting values of jump frequencies 1 and 2 are not appropriate. (parameters n49 to n50)</p> <p>OP9: Carrier frequency setting is incorrect. (parameter n46)</p>	<p>Check the setting values.</p>	
<p>OL 3</p> <p>Blinking</p>			<p>OL 3 (Over torque detection) Motor current exceeded the preset value in parameter n98.</p>	<p>Reduce the load and expand the accel/decel time.</p>	
<p>SER</p> <p>Blinking</p>	 		<p>SER (Sequence error) Inverter receives LOCAL/REMOTE select command or communication/control circuit terminal changing signals from the multi-function terminal while the inverter is outputting.</p>	<p>Check the external circuit (sequence).</p>	

Alarm Display		Inverter Status	Explanation	Causes and Corrective Actions
Digital Operator	RUN (Green) ALARM (Red)			
bb Blinking		Warning Fault contacts do not change state.	BB (External base block) Baseblock command at multi-function terminal is active. The inverter output is shut OFF (motor coasting). Temporary condition is cleared when input command is removed.	Check the external circuit (sequence).
EF Blinking			EF (Simultaneous FWD/REV run commands) When FWD and REV run commands are simultaneously input for over 500ms, the inverter stops according to parameter n04.	Check the external circuit (sequence).
STP Blinking	 or 		STP (Operator function stop) STOP/RESET is pressed during running by the control circuit terminals FWD/REV command, or by the run command from communications. The inverter stops according to parameter n04. STP (Emergency stop) Inverter receives emergency stop alarm signal. Inverter stops according to parameter n04.	Open FWD/REV command of control circuit terminals. Check the external circuit (sequence).
FAn Blinking			FAN (Cooling fan fault) Cooling fan is locked.	Check the following: • Cooling fan • Cooling fan wiring is not connected.
CE Blinking			CE (MEMOBUS communications fault)	Check the communication devices or communication signals.

Alarm Display			Inverter Status	Explanation	Causes and Corrective Actions
Digital Operator	RUN (Green)	ALARM (Red)			
OC				OC (Over current) Inverter output current momentarily exceeds approx. 200% of rated current. (Control power supply fault) Voltage fault of control power supply is detected.	<ul style="list-style-type: none"> Short circuit or grounding at inverter output side. Excessive load GD² Extremely rapid accel/decel time (parameters n19 to n22) Special motor used Starting motor during coasting Motor of a capacity greater than the inverter rating has been started. Magnetic contactor open/closed at the inverter output side.
GF				GF (Ground fault) Ground fault current at the inverter output exceeded inverter rated current.	<ul style="list-style-type: none"> Check the motor insulation. Check that the connection between inverter and motor is not damaged.
OV	●	☀	Protective Operation Output is shut OFF and motor coasts to a stop.	OV (Main circuit over voltage) Main circuit DC voltage exceeds the overfatigue detection level because of excessive regenerative energy from the motor. Detection level: 200V: Stops at main circuit DC voltage below approx. 410V 400V: Stops at main circuit DC voltage approx. 820V or more	<ul style="list-style-type: none"> Insufficient decel time (parameters n20 and n22) Lowering of overhauling load (elevator, etc.) ↓ Increase decel time.
UV1				UV1 (Main circuit low voltage) Main circuit DC voltage drops below the low voltage detection level while the inverter output is ON. 200V: Stops at main circuit DC voltage below approx. 200V (160V for single phase) 400V: Stops at main circuit DC voltage approx. 400V or more	<ul style="list-style-type: none"> Reduction of input power supply voltage Open phase of input supply Occurrence of momentary power loss ↓ Check the following: <ul style="list-style-type: none"> Power supply voltage Main circuit power supply wiring is connected. Terminal screws are securely tightened.

Alarm Display		Inverter Status	Explanation	Causes and Corrective Actions
Digital Operator	RUN (Green) ALARM (Red)			
<i>OH</i>	● ☀	Protective Operation Output is shut OFF and motor coasts to a stop.	OH (Cooling fin overheat) Temperature rise because of inverter overload operation or intake air temperature rise.	<ul style="list-style-type: none"> Excessive load Improper V/f pattern setting Insufficient axel time if the fault occurs during acceleration. Intake air temperature exceeding 122°F (50°C) Calling fan stops ↓ Check the following: <ul style="list-style-type: none"> Load size V/f pattern setting (parameters n11 to n17) Intake air temperature
<i>OL 1</i>			OL1 (Motor overload) Motor overload protection operates by built-in electronic thermal overload relay.	<ul style="list-style-type: none"> Check the load size or V/f pattern setting (parameters n09 to n15) Set the motor rated current shown on the nameplate by parameter n36.
<i>OL 2</i>			OL2 (Inverter overload) Inverter overload protection operates by built-in electronic thermal overload relay.	<ul style="list-style-type: none"> Check the load size or V/f pattern setting (parameters n09 to n15) Check the inverter capacity.
<i>OL 3</i>			OL3 (Over torque detection) Inverter output current exceeded the preset value in parameter n60. When over torque is detected, inverter performs operation according to the preset setting of parameter n59.	Check the driven machine and correct the cause of the fault, or increase the value of parameter n60 up to the highest value allowed for the machine.

Alarm Display			Inverter Status	Explanation	Causes and Corrective Actions
Digital Operator	RUN (Green)	ALARM (Red)			
<i>EF□</i>			Protective Operation Output is shut OFF and motor coasts to a stop.	EF□ (External fault) Inverter receives an external fault input from control circuit terminal. EF0: External fault reference through MEMOBUS communications EF2: External fault input command from control circuit terminal S2 EF3: External fault input command from control circuit terminal S3 EF4: External fault input command from control circuit terminal S4 EF5: External fault input command from control circuit terminal S5	Check the external circuit (sequence).
<i>F00</i>				CPF-00 Initial memory fault is detected.	Cycle power. If the fault remains, replace the digital operator or inverter.
<i>F01</i>				CPF-01 ROM error is detected.	Cycle power. If the fault remains, replace the digital operator or inverter.
<i>F04</i>				CPF-04 EEPROM fault of inverter control circuit is detected.	<ul style="list-style-type: none"> Record all parameter data and initialize the parameters. (Refer to page 25 for parameter initialization) Cycle power. If the fault remains, replace the inverter.

Alarm Display		Inverter Status	Explanation	Causes and Corrective Actions
Digital Operator	RUN (Green) ALARM (Red)			
F05		Protective Operation Output is shut OFF and motor coasts to a stop.	CPF-05 AD converter fault is detected	Cycle power. If the fault remains, replace the inverter.
F06	● ☀		CPF-06 • Option card connecting fault • A non-corresponding option card is connected.	Remove power to the inverter. Check the connection of the digital operator. Verify inverter software number (n179).
F07			CPF-07 Operator control circuit (EEPROM or AD converter) fault	Cycle power. If the fault remains, replace the digital operator or inverter.
CE			CE (MEMOBUS communications fault) Normal reception of communication data is not possible.	Check the communication devices or communication signals.
SRP	☀ or ● ☀	Stops according to parameter.	STP (Emergency stop) The inverter stops according to parameter n04 after receiving the emergency stop fault signal.	Check the external circuit (sequence).
— (OFF)	● ●		• Insufficient power supply voltage • Control power supply fault • Hardware fault	Check the following: • Power supply voltage. • Main circuit power supply wiring is connected. • Terminal screws are securely tightened. • Control sequence. Replace the inverter.

For display/clear of fault history, refer to page 29.

Appendix - CE Conformance

CE Conformance-Low Voltage Directive(LVD)Compliance

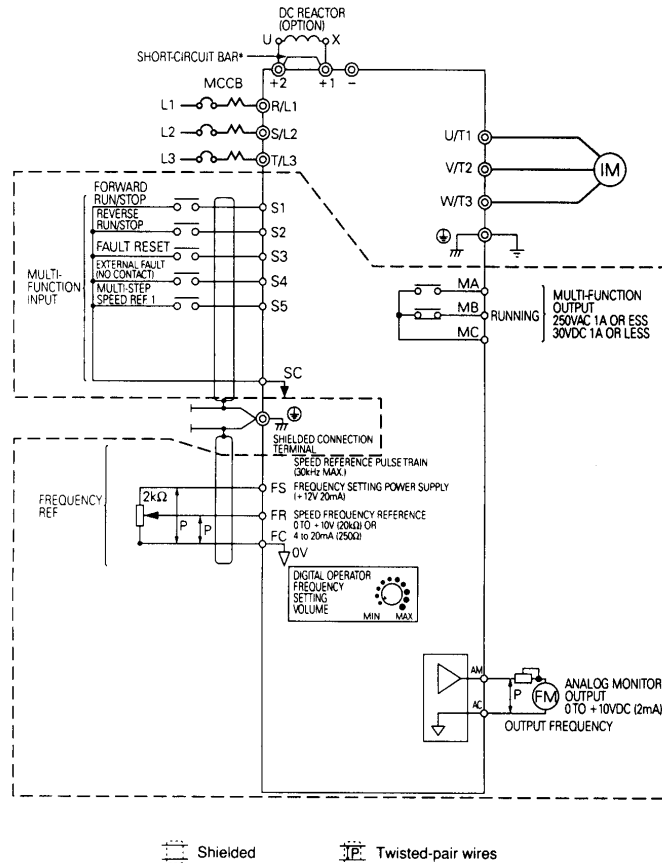

Only basic insulation is provided for the control circuit terminals. Additional insulation may be necessary in the end product.

* Short-circuit bar should be removed when connecting DC reactor.

- ① These circuits are hazardous and are separated from accessibility by protective separation.
- ② These circuits are not separated from hazardous circuits by protective separation, but only with basic insulation. These circuits cannot be accessed and must not be interconnected with any circuits which are accessible, unless they are isolated from accessible circuits by supplemental insulation. These circuits can be connected only to the following circuits:
 - 30VDC or less (overvoltage category 2)
 - 250 VAC or less (overvoltage category 2)
- ③ These circuits are not separated from hazardous circuits by protective separation, but only with basic insulation. These circuits cannot be accessed and must not be interconnected with any circuits which are accessible, unless they are isolated from accessible circuits by supplemental insulation.

CE Conformance - Electro-Magnetic Compatibility (EMC) Compliance

In order to conform to EMC standards, exclusive-use methods are required for line filter application, cable shielding and inverter installation. An outline of the methods follows.

The line filter and the inverter must be mounted on the same metal plate. The filter should be mounted as close to the inverter as practical. Keep cable as short as possible. The metal plate should be securely grounded. The ground of the line filter and inverter must be bonded to the metal plate with as much area as possible.

For line power input cable, screened cable is recommended at least within the panel. The screen of the cable should be connected to a solid ground. For the motor cable, screened cable (max. 20m) must be used and the screen of the motor cable is connected to ground at both ends by a short connection, using as large an area as practical.

For a more detailed explanation, please refer to Making YASKAWA Inverter Products Conform with EMC Directive (G-TI#99012-V7).

The following table and figures show the line filter list for EMC standards and the installation/wiring of inverter and line filter.

Line Filter List for EMC Conformance

Recommended Line Filters for VS mini J7 made by Rasmi Electronics Ltd
(200V single phase)

VS mini J7	Model	Current (A)	Weight (kg)	Dimension WxDxH
CIMR-J7AUB0P1	RS 1010-J7	10	0.6	71 x 45 x 169
CIMR-J7AUB0P2				
CIMR-J7AUB0P4				
CIMR-J7AUB0P7	RS 1020-J7	20	1.0	111 x 50 x 169
CIMR-J7AUB1P5				
CIMR-J7AUB2P2	RS 1030-J7	30	1.1	144 x 50 x 174
CIMR-J7AUB3P7	RS 1040-J7	40	1.2	174 x 50 x 174

Rated Voltage: AC 250V single phase

Ambient Temperature: 40°C (max.)

Recommended Line Filters for VS mini J7 made by Rasmi Electronic Ltd
(200 V three phase)

VS mini J7	Model	Current (A)	Weight (kg)	Dimension WxDxH
CIMR-J7AU20P1	RS 2010-J7	10	0.8	82 x 50 x 194
CIMR-J7AU20P2				
CIMR-J7AU20P4				
CIMR-J7AU20P7				
CIMR-J7AU21P5	RS 2020-J7	16	1.0	111 x 50 x 169
CIMR-J7AU22P2				
CIMR-J7AU23P7	RS 2030-J7	26	1.1	144 x 50 x 174

Rated Voltage: AC 250V three phase

Ambient Temperature: 40°C (max.)

Recommended Line Filters for VS mini J7 made by Rasmi Electronic Ltd
(400 V three phase)

VS Mini J7	Model	Current (A)	Weight (kg)	Dimension WxDxH
CIMR-J7AU40P2	RS 3005-J7	5	1.0	111 x 45 x 169
CIMR-J7AU40P4				
CIMR-J7AU40P7	RS 3010-J7	10	1.0	111 x 45 x 169
CIMR-J7AU41P5				
CIMR-J7AU42P2				
CIMR-J7AU43P7	RS 3020-J7	20	1.1	144 x 50 x 174

Rated Voltage: AC 480V three phase

Ambient Temperature: 40°C (max.)

Installation of Line Filter and Inverter VS mini J7 (CIMR-J7 □□20P1 to 23 P7)

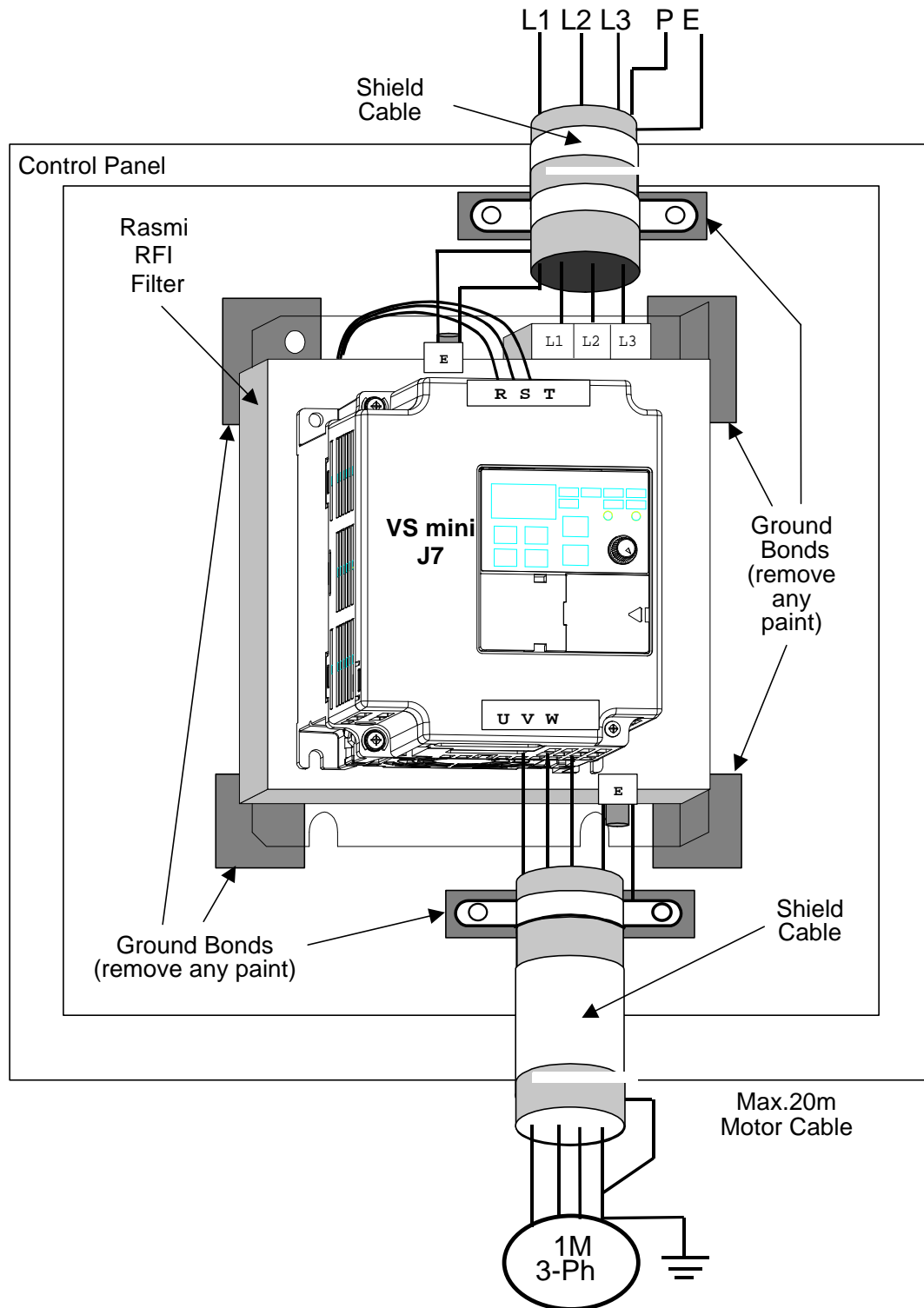

Installation of Line Filter and Inverter VS mini J7 (CIMR-J7 □□B0P1 to B1P5)

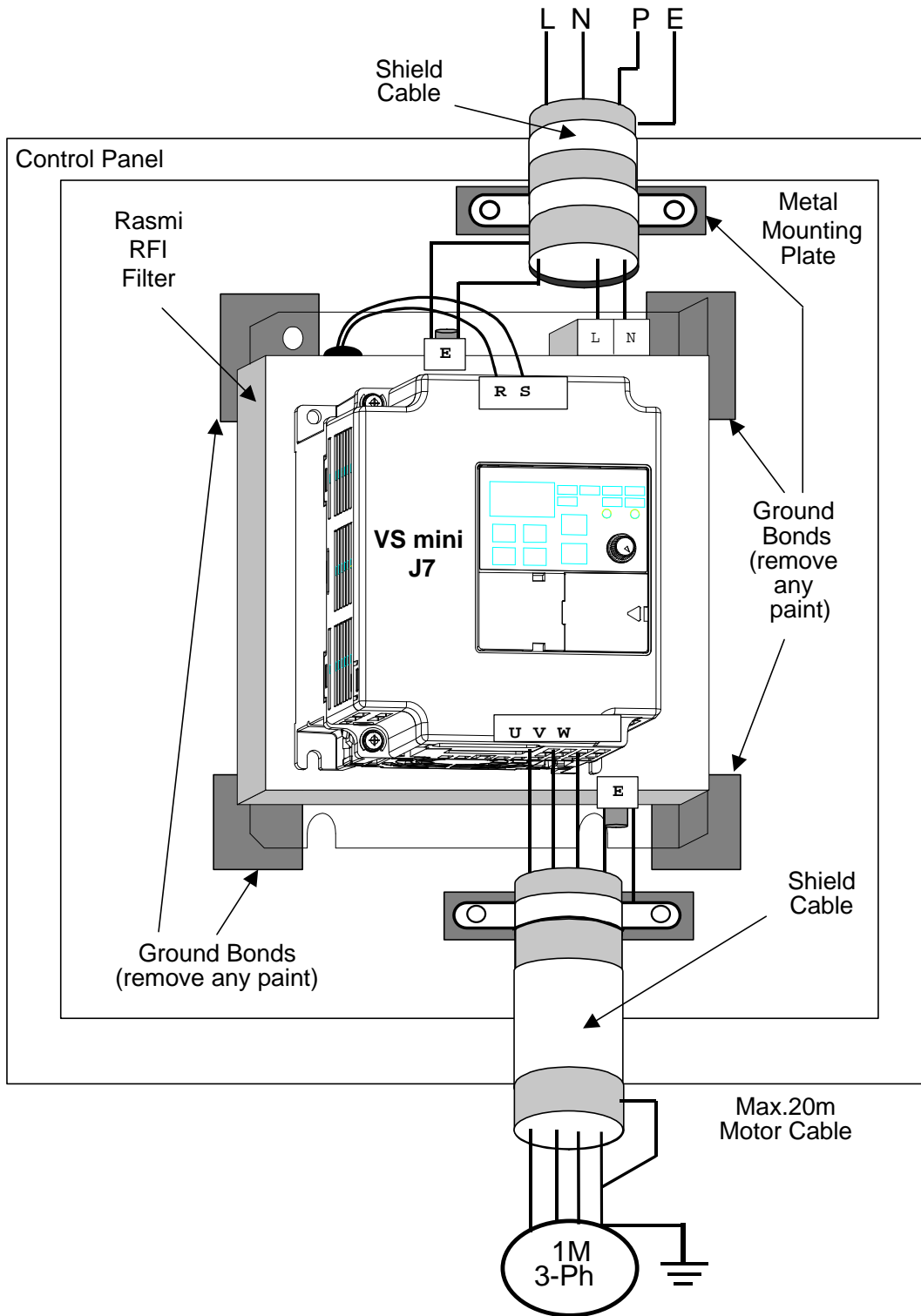

Safety Warnings and Operating Information for Inverters

Introduction

Depending on their protection rating configuration, parts of inverters can have live, uninsulated and hot surfaces during operation. If housing components, the control unit or terminal covers are removed, incorrect installation and operation can lead to serious injuries and damage to other installations. It is thus absolutely essential to observe all the warnings and instructions in the operating manual. Installation, setup and maintenance should only be performed by properly qualified staff. IEC 364 / Cenelec HD 384 or DIN VDE 0100 and IEC 664 or DIN VDE. The applicable national safety and accident prevention regulations must also be observed.) For the purpose of observance of the safety requirement qualified staff are defined as individuals who are familiar with the installation, setup and operation of the converters and who have the proper qualifications for this work.

Proper use for intended purpose

Inverters are designed for installation in electrical systems or machines. A converter installed in a machine may only be activated if the machine conforms to the provisions of EU directive 89/392/EEC (machine directives). EN 60204 must also be observed. The converter may also only be operated if the requirements of the EMC directive (89/336/EEC) are also satisfied. This frequency converter conforms to the requirements of the low voltage directive, 73/23/EEC. The harmonized standards of the prEN 50178/DIN VDE 0160 series have been applied, in combination with EN 660439-1 / VDE 06600 Part 500 and EN 60146 / VDE 0558. The specifications on the ratings plate and the specifications and connection requirements described in the documentation must be observed at all times.

Transportation and storage

All instructions for transport, storage and proper handling must be observed. Climatic and environmental conditions must conform to the requirements of prEN 50178.

Installation

The converters must be installed and cooled in compliance with the regulations outlines and referred to in the documentation. The cooling air flow direction is an important requirement that must be observed. This means that the unit may only be installed and operated in the specified orientation (e.g. upright). All distances specified must also be observed. The converters must be protected against excessive stresses. No components may be bent and no distances required for proper insulation may be changed. To prevent the risk of static electricity damage never touch electronic components or contacts.

Electrical connections

All national safety regulations (e.g. VBG 4) must be observed when working on live equipment. The electrical installation of the units must conform to the applicable regulations. For further information please refer to the documentation. In particular, please take care to observe all installation instructions regarding proper EMC immunity, e.g. for shielding, earthing, location of filters and cable routing. This also applies for equipment with CE approvals. Compliance with the EMC legislation limits is the responsibility of the machine or system manufacturer.

RCCBs

For information on the use of RCCBs with inverters please contact your supplier or Yaskawa representative.

Operation

In some systems it may be necessary to install additional monitoring and protective facilities to comply with the applicable safety and accident prevention regulations. The only changes permitted are to the operator software of the inverters. Please note that the capacitors can remain charged for up to around 5 minutes after the frequency converter has been disconnected from the power supply. You should thus always wait for a short period before opening the unit and touching the electrical connections.

EU Manufacturer's Declaration

Products

Static inverter, series VS mini J7

Scope

YASKAWA inverters are components (**BDM***, defined by IEC 22g/21CDV) designed exclusively for installation in machines or systems (end products) by qualified re-users (e.g. mechanical engineering manufacturers).

Responsibility

As a component manufacturer we are responsible for the provision of installation instructions. These can be found in the installation guidelines publication G-TI#99012-V7 (a Yaskawa publication free upon request).

Our products have been tested by authorized bodies pursuant to the requirements of the standard listed below. The products conform to these standards listed below. The products conform to these standards listed below. The products conform to these standards, subject to due and proper observation of the installation instructions provided in section 10 of this manual:

Immunity - EMC resistance pursuant to EN50082-2 (1995)

ENV50204 (1995)
EN61000-4-2 (1996)
EN61000-4-4 (1995)
EN61000-4-6 (1996)
EN61000-4-8 (1994)

Emission - EMC interference emissions pursuant to EN50081-2 (1993)

EN55011 (1991)	Class B Group 1 Up to 10m motor cable
	Class A Group 1 Up to 20m motor cable

YASKAWA Electric Europe GmbH
Am Kronberger Hang 2
65824 Schwalbach am Taunus
Germany

Always observe all the safety instructions provided in this product documentation!

***AdÜ**: Abkürzung bitte kontrollieren.



YASKAWA ELECTRIC AMERICA, INC.

Chicago-Corporate Headquarters 121 Norman Drive South, Waukegan, IL 60085, U.S.A.
Phone: (847) 887-7000 Fax: (847) 887-7310 Internet: <http://www.yaskawa.com>

MOTOMAN INC.

805 Liberty Lane, West Carrollton, OH 45449, U.S.A.
Phone: (937) 847-6200 Fax: (937) 847-6277

YASKAWA ELECTRIC CORPORATION

New Pier Takeshiba South Tower, 1-16-1, Kaigan, Minatoku, Tokyo, 105-0022, Japan
Phone: 81-3-5402-4511 Fax: 81-3-5402-4580 Internet: <http://www.yaskawa.co.jp>

YASKAWA ELETRICO DO BRASIL COMERCIO LTDA.

Avenida Fagundes Filho, 620 Bairro Saude Sao Paulo-SP, Brasil CEP: 04304-000
Phone: 55-11-5071-2552 Fax: 55-11-5581-8795 E-mail: yaskawabrasil@originet.com.br

YASKAWA ELECTRIC EUROPE GmbH

Am Kronberger Hang 2, 65824 Schwalbach, Germany
Phone: 49-6196-569-300 Fax: 49-6196-888-301 Internet: <http://www.yaskawa.de>

MOTOMAN ROBOTICS AB

Box 504 S38525, Torsas, Sweden
Phone: 46-486-48800 Fax: 46-486-41410

MOTOMAN ROBOTEC GmbH

Kammerfeldstraße 1, 85391 Allershausen, Germany
Phone: 49-8166-900 Fax: 49-8166-9039

YASKAWA ELECTRIC UK LTD.

1 Hunt Hill Orchardton Woods Cumbernauld, G68 9LF, Scotland, United Kingdom
Phone: 44-12-3673-5000 Fax: 44-12-3645-8182

YASKAWA ELECTRIC KOREA CORPORATION

Paik Nam Bldg. 901 188-3, 1-Ga Euljiro, Joong-Gu, Seoul, Korea
Phone: 82-2-776-7844 Fax: 82-2-753-2639

YASKAWA ELECTRIC (SINGAPORE) PTE. LTD.

Head Office: 151 Lorong Chuan, #04-01, New Tech Park Singapore 556741, SINGAPORE
Phone: 65-282-3003 Fax: 65-289-3003

TAIPEI OFFICE (AND YATEC ENGINEERING CORPORATION)

10F 146 Sung Chiang Road, Taipei, Taiwan
Phone: 886-2-2563-0010 Fax: 886-2-2567-4677

YASKAWA JASON (HK) COMPANY LIMITED

Rm. 2909-10, Hong Kong Plaza, 186-191 Connaught Road West, Hong Kong
Phone: 852-2803-2385 Fax: 852-2547-5773

BEIJING OFFICE

Room No. 301 Office Building of Beijing International Club,
21 Jianguomanwai Avenue, Beijing 100020, China
Phone: 86-10-6532-1850 Fax: 86-10-6532-1851

SHANGHAI OFFICE

27 Hui He Road Shanghai 200437 China
Phone: 86-21-6553-6600 Fax: 86-21-6531-4242

SHANGHAI YASKAWA-TONJI M & E CO., LTD.

27 Hui He Road Shanghai 200437 China
Phone: 86-21-6533-2828 Fax: 86-21-6553-6677

BEIJING YASKAWA BEIKE AUTOMATION ENGINEERING CO., LTD.

30 Xue Yuan Road, Haidian, Beijing 100083 China
Phone: 86-10-6232-9943 Fax: 86-10-6234-5002

SHOUGANG MOTOMAN ROBOT CO., LTD.

7, Yongchang-North Street, Beijing Economic & Technological Development Area,
Beijing 100076 China

Phone: 86-10-6788-0551 Fax: 86-10-6788-2878